



This document was prepared for the ETI by third parties under contract to the ETI. The ETI is making these documents and data available to the public to inform the debate on low carbon energy innovation and deployment.

Programme Area: Marine

Project: ReDAPT

Title: Horizontal Axis Tidal Turbines

Abstract:

This standard provides principles, technical requirements and guidance for the design, construction and in-service inspection of Horizontal Axis Tidal Turbine (HATT) and it is the basis for its certification. The specific certification requirements and respective deliverables for HATT are in line with the overall certification principles and procedures defined in DNV-OSS-312 Certification of Tidal and Wave Energy Converters.

Context:

One of the key developments of the marine energy industry in the UK is the demonstration of near commercial scale devices in real sea conditions and the collection of performance and environmental data to inform permitting and licensing processes. The ETI's ReDAPT (Reliable Data Acquisition Platform for Tidal) project saw an innovative 1MW buoyant tidal generator installed at the European Marine Energy Centre (EMEC) in Orkney in January 2013. With an ETI investment of £12.6m, the project involved Alstom, E.ON, EDF, DNV GL, Plymouth Marine Laboratory (PML), EMEC and the University of Edinburgh. The project demonstrated the performance of the tidal generator in different operational conditions, aiming to increase public and industry confidence in tidal turbine technologies by providing a wide range of environmental impact and performance information, as well as demonstrating a new, reliable turbine design.

Disclaimer:

The Energy Technologies Institute is making this document available to use under the Energy Technologies Institute Open Licence for Materials. Please refer to the Energy Technologies Institute website for the terms and conditions of this licence. The Information is licensed 'as is' and the Energy Technologies Institute excludes all representations, warranties, obligations and liabilities in relation to the Information to the maximum extent permitted by law. The Energy Technologies Institute is not liable for any errors or omissions in the Information and shall not be liable for any loss, injury or damage of any kind caused by its use. This exclusion of liability includes, but is not limited to, any direct, indirect, special, incidental, consequential, punitive, or exemplary damages in each case such as loss of revenue, data, anticipated profits, and lost business. The Energy Technologies Institute does not guarantee the continued supply of the Information. Notwithstanding any statement to the contrary contained on the face of this document, the Energy Technologies Institute confirms that the authors of the document have consented to its publication by the Energy Technologies Institute.

DOCUMENT INFORMATION

Title of document: Horizontal axis tidal turbines

Date: 15-12-2014

Revision: 1

Author: DNV GL – Energy, Renewables Certification – Wave and Tidal

STANDARD

Horizontal axis tidal turbines

CONTENTS

1	INTRODUCTION	13
1.1	General.....	13
1.2	Objectives.....	13
1.3	Scope and application.....	14
1.4	Non-DNV GL codes.....	18
1.5	Equivalence and future developments.....	18
1.6	References.....	18
1.7	Definitions.....	24
1.7.1	Verbal forms.....	24
1.7.2	Terms.....	24
1.8	Acronyms, Abbreviations and Symbols.....	31
1.8.1	Acronyms and abbreviations.....	31
1.8.2	Symbols.....	32
1.9	Approach regarding configurations not included in the HATT systems.....	34
1.10	Certification principles and risk based approach.....	34
1.10.1	Introduction.....	34
1.10.2	Risk based approach – overall description.....	35
1.10.3	Definition phase.....	35
2	DESIGN PRINCIPLES	42
2.1	Introduction.....	42
2.1.1	Safety philosophy.....	42
2.1.2	Safety classes and target safety level.....	42
2.2	Structural design.....	43
2.2.1	Objectives.....	43
2.2.2	Aim of the design.....	44
2.2.3	Design conditions.....	44
2.3	Limit states - structures.....	45
2.4	Design by the partial safety factor method - structures.....	46
2.4.1	General.....	46
2.4.2	Load and resistance factors.....	46
2.5	Design by direct simulation of combined load effect of simultaneous load processes – structures.....	46
2.5.1	General.....	46
2.6	Design assisted by testing - structures.....	47
2.6.1	General.....	47
2.7	Probability-based design- structures.....	47
2.8	Systems design.....	47
2.8.1	General.....	47
3	MANUALS FOR ONSHORE AND OFFSHORE WORKS.....	48
3.1	General requirements.....	48
3.2	Sea transport and offshore installation manual.....	49
3.2.1	Objective and format.....	49
3.2.2	Scope and content.....	49
3.3	Commissioning manual.....	51
3.3.1	Objective and format.....	51
3.3.2	Scope and content.....	51
3.4	Operating manual.....	53
3.4.1	Objective and format.....	53
3.4.2	Scope and content.....	53
3.5	Maintenance manual.....	55
3.5.1	Objective and format.....	55
3.5.2	Scope and content.....	55

3.6	Periodical inspections documentation	57
3.6.1	Objective and format	57
3.6.2	Scope and content	57
4	SITE CONDITIONS AND CHARACTERISATION	59
4.1	Introduction	59
4.1.1	Definition	59
4.2	Current climate	59
4.2.1	Current conditions	59
4.2.2	Parameters for normal current conditions	60
4.2.3	Current data	60
4.2.4	Current measurements	62
4.2.5	Current modelling	63
4.2.6	Reference current conditions and reference current speeds	66
4.3	Wave climate	66
4.3.1	Wave parameters	66
4.3.2	Wave measurements	67
4.3.3	Wave modelling	68
4.3.4	Reference sea states and reference wave heights	68
4.4	Water level	68
4.4.1	Water level parameters	68
4.4.2	Water level data	70
4.4.3	Water level measurements	70
4.4.4	Water level modelling	70
4.5	Wind climate	71
4.5.1	Wind parameters	71
4.5.2	Wind data	71
4.5.3	Wind modelling	71
4.5.4	Reference wind conditions and reference wind speeds	72
4.6	Ice	72
4.7	Seabed investigations and geotechnical data	72
4.7.1	Seabed investigations	72
4.7.2	Seabed investigations are normally to comprise the following types of investigation:	74
4.8	Other site conditions	76
4.8.1	Seismicity	76
4.8.2	Salinity	76
4.8.3	Temperature	76
4.8.4	Water and air density	76
4.8.5	Marine growth	76
4.8.6	Sediments	77
4.8.7	Ship traffic	77
4.8.8	Semi-submerged debris, marine mammal and fish collisions	77
4.8.9	Disposed matters	78
4.8.10	Pipelines and cables	78
4.8.11	Lightning	78
4.8.12	Electrical power network conditions	78
5	LOADS AND LOAD EFFECTS	80
5.1	Introduction	80
5.1.1	General	80
5.1.2	Extreme loads	80
5.1.3	Fatigue loads	80
5.1.4	Transportation loads	80
5.1.5	Tidal turbine loads	80
5.1.6	Blockage and wake-induced loads	81
5.1.7	Other loads	81
5.2	Design specific loads	81
5.2.1	Multiple turbines per supporting structure	81
5.2.2	Multiple rotors	81

5.2.3	Fixed yaw system	82
5.3	Basis for selection of characteristic loads.....	82
5.3.1	General	82
5.4	Permanent loads (G)	84
5.4.1	General	84
5.5	Variable functional loads (Q)	85
5.5.1	General	85
5.5.2	Ship impacts and collisions	86
5.6	Environmental loads (E).....	86
5.6.1	General	86
5.6.2	Uncertainty in site conditions	88
5.6.3	Design load cases	88
5.6.4	Power production (DLC 1.1 to 1.2).....	92
5.6.5	Power production plus occurrence of fault or loss of electrical network connection (DLC 2.1 - 2.3).....	93
5.6.6	Start up (DLC 3.1 to 3.3).....	94
5.6.7	Normal shut down (DLC 4.1 to 4.2).....	94
5.6.8	Emergency shutdown (DLC 5.1)	94
5.6.9	Parked (standstill or idling) (DLC 6.1 to 6.3)	95
5.6.10	Parked plus fault conditions (DLC 7.1 to 7.3).....	95
5.6.11	Transport, assembly, maintenance and repair (DLC 8.1 to 8.2)	97
5.6.12	Multiple rotor specific load cases.....	98
5.6.13	Ice loads	99
5.6.14	Water level loads	99
5.6.15	Scour	99
5.6.16	Loads during load-out, transport and installation	99
5.6.17	Fatigue loads	99
5.7	Combination of Environmental Loads	100
5.7.1	General	100
5.7.2	Linear combinations of current load and wave load	101
5.7.3	Combination of current load and wave load by simulation	101
5.7.4	Basic load cases	101
5.7.5	Transient load cases.....	102
5.7.6	Load combination for the fatigue limit state	103
5.8	Load effect analysis	104
5.8.1	Definition.....	104
5.9	Accidental loads (A).....	104
5.9.1	Definition.....	104
5.10	Deformation loads (D)	105
5.10.1	General	105
6	LOAD & RESISTANCE FACTORS	106
6.1	Load factors	106
6.1.1	Load factors for the ULS	106
6.1.2	Load factor for the FLS	106
6.1.3	Load factor for the SLS.....	107
6.1.4	Load factor for the ALS.....	107
6.1.5	Special partial safety factors	107
6.2	Uncertainties associated with site characterisation data	107
6.3	Resistance factors	107
6.3.1	Resistance factors for the ULS	107
6.3.2	Resistance factors for the FLS	107
6.3.3	Resistance factors for the ALS and the SLS	107
7	MATERIALS FOR STRUCTURES AND BLADES.....	108
7.1	Introduction	108
7.1.1	General	108
7.2	Selection of metallic materials	108
7.2.1	General	108
7.2.2	Structural steel and aluminium.....	108

7.2.3	Bolting materials	108
7.3	Selection of concrete materials	109
7.3.1	General	109
7.4	Selection of grout materials.....	109
7.4.1	General	109
7.5	Selection of composite materials	109
7.5.1	General	109
7.6	Selection of materials for solid ballast.....	109
7.6.1	General	109
7.7	Materials for blades	109
7.7.1	General	109
7.7.2	Fibre-reinforced plastic materials	112
7.7.3	Sandwich structures.....	116
7.7.4	Adhesives	118
7.7.5	Laminated wood	120
7.7.6	Iron castings	120
7.7.7	Rolled steel plates.....	120
7.7.8	Surface finishing	120
7.7.9	Qualification of substitute materials	121
8	DESIGN AND CONSTRUCTION OF STEEL STRUCTURES	122
8.1	Capacity checks	122
8.1.1	Ultimate limit states – general.....	122
8.1.2	Ultimate limit states – shell structures.....	122
8.1.3	Ultimate limit states – tubular members, tubular joints and conical transitions	123
8.1.4	Ultimate limit states – non-tubular beams, columns and frames	123
8.1.5	Ultimate limit states – special provisions for plating, stiffeners and girders	124
8.1.6	Serviceability limit states	124
8.1.7	Fatigue limit states	124
8.2	Connections	128
8.2.1	General	128
8.2.2	Bolted connections.....	128
8.2.3	Grouted connections	129
8.3	Foundation.....	129
8.3.1	General	129
9	DESIGN AND CONSTRUCTION OF BLADES	131
9.1	Design principles.....	131
9.1.1	General	131
9.1.2	Analysis methodology.....	131
9.1.3	Load effects	133
9.1.4	Fatigue load effects.....	133
9.1.5	Combining load and environment.....	134
9.1.6	Thermal stresses	134
9.1.7	Swelling	134
9.1.8	Impact	135
9.1.9	Design based on large scale testing	135
9.2	Failure mechanisms.....	135
9.2.1	General	135
9.2.2	Matrix cracking.....	135
9.2.3	Delamination.....	136
9.2.4	Fibre dominated failure.....	137
9.2.5	Laminate failure	138
9.2.6	Permeability.....	138
9.2.7	Maximum deflection	138
9.2.8	Modal behaviour of the blade	138
9.2.9	Creep and stress relaxation (in water).....	139
9.2.10	Impact	139
9.2.11	Wear.....	140

9.2.12	Chemical and water degradation	140
9.2.13	UV exposure	140
9.2.14	Core failure (sandwich)	140
9.2.15	Fatigue.....	141
9.2.16	Stress rupture	141
9.2.17	Adhesive bonding failure.....	141
9.2.18	Polymer failure	141
9.3	Design requirements for main blade	142
9.3.1	Rupture	142
9.3.2	Buckling	142
9.3.3	Deflections.....	143
9.3.4	Torsion.....	144
9.3.5	Fluid tightness.....	144
9.3.6	Max change of profile shape.....	144
9.3.7	Erosion.....	144
9.3.8	Cavitation	145
9.3.9	Aeration	145
9.3.10	Corrosion.....	145
9.3.11	Marine growth	145
9.3.12	Impact resistance	145
9.4	Design requirements for joints between blade parts	145
9.4.1	General	145
9.4.2	Failure modes	146
9.4.3	Torsion.....	147
9.4.4	Corrosion.....	147
9.5	Design requirements for root joint.....	147
9.5.1	General	147
9.6	Partial safety factors for materials.....	148
9.6.1	General	148
9.6.2	Ultimate limit state (ULS)	148
9.6.3	Fatigue limit state (FLS)	148
9.6.4	Partial material safety factors for frps and Sandwich Composites	149
9.6.5	Buckling material factors	150
9.6.6	Inter-fibre failure analysis.....	150
9.6.7	Partial material safety factors for bonded joints	150
9.6.8	Structural health monitoring of tidal blades.....	151
10	MACHINERY SYSTEMS AND COMPONENTS	152
10.1	General.....	152
10.2	Pitch mechanism with bearing and actuator.....	153
10.2.1	Systems with rotary actuation	153
10.2.2	Systems with hydraulic actuation.....	154
10.2.3	Blade bearings	154
10.2.4	Electrical drives in pitch systems	154
10.3	Yaw system	154
10.3.1	Systems with rotary actuation	155
10.3.2	Systems with lateral thrust units	155
10.3.3	Yaw bearings	155
10.4	Drivetrain.....	155
10.4.1	Rotor shaft.....	155
10.4.2	Main bearings.....	156
10.4.3	Main gearbox	157
10.4.4	Coupling (and high speed shaft)	159
10.4.5	Mechanical brakes	159
10.4.6	Locking devices	159
10.5	Auxiliary systems	160
10.5.1	Bilge	160
10.5.2	Pressure hull, ballast system and buoyancies	161
10.5.3	Heating ventilation and air conditioning	161
10.5.4	Cooling.....	161

10.6	Hydraulic system	162
10.6.1	Documentation	162
10.6.2	Design requirements	162
11	PROTECTION FUNCTIONS AND SAFEGUARDING	163
11.1	General.....	163
11.2	Control system and control concept.....	163
11.2.1	Control system	163
11.2.2	Control concept	163
11.2.3	Automatic re-start	164
11.3	Safety system and safety concept	165
11.3.1	Safety system	165
11.3.2	Safety concept	165
11.3.3	Clearance	166
11.4	Protection functions.....	167
11.5	Instrumentation of the control and safety systems	169
11.5.1	Rotational speed.....	169
11.5.2	Electric power	169
11.5.3	Voltage and frequency.....	170
11.5.4	Excessive foundation vibration	170
11.5.5	Current speed	170
11.5.6	Current direction	171
11.5.7	Blade pitch angle	171
11.5.8	Short-circuit.....	171
11.5.9	Functionality of the control system and data storage	171
11.5.10	Twisting of flexible cables	172
11.5.11	Functionality of essential machinery components	172
11.5.12	Emergency stop buttons	172
11.5.13	Leakage	173
11.5.14	Collision warning	173
11.6	Actuating mechanisms	173
11.6.1	Braking systems	173
11.6.2	Yaw system	174
11.6.3	Drain system.....	175
11.7	Auxiliary power supply for protection functions	175
11.8	Remote control	176
11.9	Safeguarding	176
11.10	Assessment documents.....	177
12	ELECTRICAL SYSTEMS	179
12.1	Electrical systems	179
12.1.1	Area of Application.....	179
12.1.2	Standards	179
12.1.3	Operating and environmental conditions	179
12.1.4	Specification and testing of inside equipment	179
12.1.5	General Design requirements	180
12.1.6	Parallel operation with public power supply networks	181
12.1.7	Assessment documents	181
12.1.8	Stand-alone operation	184
12.2	Electrical machines.....	184
12.2.1	General	184
12.2.2	Rating of generators	185
12.2.3	Rating of auxiliary motors	186
12.2.4	Materials	186
12.2.5	Ventilation and cooling	186
12.2.6	Windings	186
12.2.7	Bearings and couplings.....	186
12.2.8	Generator testing	187
12.2.9	Earthing	187
12.2.10	Carbon brushes	187

12.2.11	Direct drive generator (low speed)	187
12.3	Power transformer	187
12.3.1	General	187
12.3.2	Installation	188
12.3.3	Protection	188
12.3.4	Dry-type power transformer.....	188
12.3.5	Liquid-immersed power transformers	189
12.4	Frequency converters	189
12.4.1	General	189
12.4.2	General design and data to be provided.....	190
12.4.3	Protection equipment	193
12.4.4	Capacitors	194
12.4.5	Routine testing	194
12.4.6	Type testing.....	194
12.4.7	Installation, commissioning and maintenance.....	194
12.4.8	Frequency converters connected to other systems than generator	195
12.5	Medium-voltage switchgear	195
12.5.1	General	195
12.5.2	Protective measures and tests.....	195
12.5.3	Pressure relief	195
12.5.4	SF6 switchgear.....	196
12.6	Back-up power supply system	196
12.6.1	General	196
12.6.2	Charging equipment.....	196
12.6.3	Energy storage system	197
12.6.4	Installation and operation of batteries	197
12.6.5	Backup power supply for long periods	197
12.7	Low-voltage switchgear, controlgear and switchboards	198
12.7.1	General	198
12.7.2	Protection – general.....	198
12.7.3	Short-circuit and electric arc protection	198
12.7.4	Overload protection	199
12.7.5	Overcurrent protection	199
12.7.6	Selectivity.....	199
12.7.7	Residual current	199
12.7.8	Switching devices – general	199
12.7.9	Switches.....	199
12.7.10	Circuit breakers	199
12.7.11	Fuses	200
12.7.12	Motor-circuit switches	200
12.7.13	Distribution panels – general.....	200
12.7.14	Protection class of distribution panels.....	200
12.7.15	Corrosion protection of distribution panels	201
12.7.16	Climate of distribution panels	201
12.7.17	Tests of distribution panels	201
12.7.18	Terminal bars.....	201
12.7.19	Conductors in panels.....	201
12.7.20	Busbars	201
12.7.21	Control, measuring and indicating circuits.....	201
12.8	Cables, lines and accessories	202
12.8.1	General	202
12.8.2	Selection of cables, lines and accessories.....	202
12.8.3	Documents to be submitted for Design Assessment	203
12.8.4	Loading and protection of cables and lines	203
12.8.5	Installation of cables and lines.....	203
12.8.6	Risers.....	204
12.9	Lightning protection	204
12.9.1	General	204
12.9.2	Lightning protection level (LPL)	204
12.9.3	Lightning protection zone (LPZ)	204
12.9.4	Surge protection devices	205

12.9.5	Equipotential bonding	205
12.9.6	Earthing system	206
12.10	Array cabling	206
12.10.1	General	206
12.10.2	Type test	207
12.10.3	Factory acceptance test (FAT)	208
12.10.4	Installation	208
12.10.5	DC power systems	209
13	CORROSION PROTECTION.....	210
13.1	General.....	210
13.2	Corrosion zones and applicable methods for corrosion control	210
13.2.1	Atmospheric zone	210
13.2.2	Splash zone	210
13.2.3	Submerged zone	211
13.2.4	Transition zones	211
13.2.5	Effect of high current velocity on corrosion protection	211
13.3	Corrosion allowance	212
13.3.1	General	212
13.4	Cathodic protection	212
13.4.1	General	212
13.4.2	Galvanic anode cathodic protection (GACP)	212
13.4.3	Impressed current cathodic protection (ICCP)	212
13.5	Corrosion protective coatings and corrosion resistant materials.....	213
13.5.1	Corrosion protective coatings	213
13.5.2	Corrosion Resistant materials	213
14	FABRICATION, TRANSPORT, INSTALLATION, COMMISSIONING AND RETRIEVAL.....	214
14.1	Certification surveillances.....	214
14.2	General requirements to marine operations documentation	214
14.3	Manufacturing surveillance	216
14.4	Transport and installation surveillance	216
14.5	Prototype commissioning surveillance	217
14.5.1	Procedure of the prototype commissioning surveillance	218
14.6	Project commissioning surveillance.....	220
14.7	Retrieval	221
15	MAINTENANCE AND PERIODICAL INSPECTIONS.....	222
15.1	General.....	222
15.2	Planned preventive maintenance.....	222
15.3	Condition-based maintenance.....	223
15.4	Periodical inspections.....	224
15.4.1	Inspection report	226
16	CERTIFICATION PROCEDURES	227
16.1	Introduction	227
16.2	Overall certification scope	227
16.2.1	General	227
16.2.2	Design basis assessment	228
16.2.3	Load assessment	228
16.2.4	Design assessment	229
16.2.5	Test plan evaluation.....	229
16.2.6	Manufacturing surveillance.....	230
16.2.7	Manufacturing assessment.....	230
16.2.8	Installation evaluation	231
16.2.9	Final evaluation / commissioning inspection	231
16.2.10	Type testing and type characteristic measurements	232

16.2.11	Periodical inspections	232
16.2.12	Documentation for certification	233
16.3	Certification deliverables	236
16.4	Validity of the certificate	236
16.5	Prototype certification	238
16.5.1	General	238
16.5.2	Scope of prototype certification	238
16.5.3	Validity of the prototype certificate	240
16.5.4	Documentation for the prototype certification	241
16.6	Type certification	241
16.6.1	General	241
16.6.2	Scope of the type certification	242
16.6.3	Validity of the type certificate	242
16.7	Component certification	243
16.7.1	General	243
16.7.2	Case-by-case approval	244
16.7.3	Type approval	244
16.7.4	Documentation for the certification	245
16.7.5	Manufacturing survey arrangement	246
16.8	Project certification	246
16.8.1	Scope of the Project Certification	246
16.8.2	Validity of the project certificate	249
17	CERTIFICATION TESTS AND MEASUREMENTS	251
17.1	Introduction	251
17.2	Blade testing	252
17.2.1	General	252
17.2.2	Selection of test blade and specification of testing	253
17.2.3	Parts of the blade to be tested	253
17.2.4	Natural frequencies and damping determination	253
17.2.5	Static testing	254
17.2.6	Fatigue testing	257
17.2.7	Final static testing (residual strength testing)	260
17.2.8	Quality management of testing	260
17.2.9	Reporting	260
17.3	Main gearbox	261
17.3.1	General	261
17.3.2	Gearbox prototype test at the test bench	261
17.3.3	Gearbox Robustness test	262
17.3.4	Gearbox prototype test at the tidal turbine	262
17.3.5	Documentation of the prototype tests	263
17.4	Generator	263
17.4.1	Overspeed test	263
17.4.2	Routine test	264
17.4.3	Test of direct drive generator	264
17.5	Transformer	264
17.5.1	Dry-type transformer	264
17.6	Converter	264
17.6.1	Type testing	265
17.6.2	Routine tests	266
17.7	Medium-voltage switchgear	266
17.8	Load measurements	266
17.8.1	Objectives	266
17.8.2	Analytical model validation	267
17.9	Power performance measurements	269
17.9.1	General	269
17.10	Safety and function tests	270
17.10.1	Test of the safety system	271
17.10.2	Test of the control system	271



APPENDIX A – TECHNOLOGY ASSESSMENT, NOVEL ASPECTS AND FMIRR 275

APPENDIX B – DIAGRAMMATIC PRESENTATION OF TIDAL TURBINES CONTROL AND SAFETY SYSTEMS..... 276

APPENDIX C – SUMMARY ON THE PROTECTION FUNCTIONS DESIGN “TURBINE BEHAVIOUR ON EXCESSIVE CABLE TWIST” (EXAMPLE) 277

APPENDIX D – CONTROL AND SAFETY CONCEPT SUMMARY (EXAMPLE) 279

APPENDIX E – GENERATOR PARAMETERS FOR ELECTRICAL CALCULATIONS AND SIMULATIONS 282



1 INTRODUCTION

1.1 General

This standard provides principles, technical requirements and guidance for the design, construction and in-service inspection of Horizontal Axis Tidal Turbine (HATT) and it is the basis for its certification. The specific certification requirements and respective deliverables for HATT are in line with the overall certification principles and procedures defined in DNV-OSS-312 *Certification of Tidal and Wave Energy Converters*.

This standard covers design of structures (including blades, rotor, nacelle, supporting structure and foundations), machinery, safety, controls & instrumentation and electrical systems. The standard takes transportation, deployment, retrieval and inspection issues into account to the extent necessary in the context of overall certification. The design principles and overall requirements are defined in this standard. Wherever possible, it makes reference to requirements set forth in other DNV GL standards and recommended practices as well as relevant international standards.

This standard is written for worldwide application. National and governmental regulations may include requirements in excess of the provisions given by this standard depending on the size, type, location and intended service of the HATT.

In principle, the standard is written for site-specific design; however, it is suitable with a consideration of mass production to design HATT not for a specific site but rather for a class of environmental conditions and then, for each application, qualify the structure for the specific location in accordance with this standard. A class of environmental conditions, defined to be used as a target for design of HATT units for mass production, would have to cover environmental conditions in a broad sense.

In HATT technology, different approaches and targets than described in this standard are expected. As the technology is still in its early years, the requirements given here are based on limited in-service experience that has not covered all novelty and uncertainty aspects. In order to calibrate the requirements and to be able to adjust them to new approaches, targets or new facts from in-service life, a risk based approach has been used to identify the risk level of the generic HATT and it shall be maintained to provide the background for future adjustments.

The information provided by the Energy Technologies Institute (ETI) programmes PerAWaT (Performance Assessment of Wave and Tidal Array Systems) and ReDAPT (Reliable Data Acquisition Platform for Tidal) was the foundation for the definition of certification requirements and the risk calibration in this standard.

This standard represents the state of the art of HATT technology with respect to the structural integrity and integral reliability of HATT.

Certification according to this standard does not cover additional requirements, particularly in respect of the occupational safety, shipping and navigation. These requirements shall be taken into account from the correspondent international, national and local regulations.

1.2 Objectives

The standard specifies general principles and requirements for the design, manufacturing, testing, deployment (transportation and installation), commissioning, in-service life as well as retrieval of HATT.

The objectives of this standard are to:

- provide an internationally acceptable level of safety by defining minimum requirements for structures, structural components (including blades), machinery systems, machinery components, safety and control systems, electrical systems and corrosion protection systems (in combination with referenced standards, recommended practices, guidelines, etc.);
- serve as a contractual reference document between suppliers and purchasers related to design, construction, installation and in-service inspection;
- serve as a guideline for designers, suppliers, purchasers, insurance companies and regulators;
- specify procedures and requirements for HATT subject to DNV GL certification; and
- serve as a basis for verification of HATT for which DNV GL is contracted to perform the verification.

1.3 Scope and application

The standard is applicable to HATT with a central hub and fixed sea-bed support structure using single or multiple energy extraction units.

Descriptions of HATT system are provided in the list below.

- The types of fixed foundations considered in this standard are gravity based, mono-pile, multi-pile and anchors. The elevation of the turbine stand shall be at a fixed distance from the seabed during operation.
- The number of turbines per stand considered in this standard is a single fixed to the sea-bed support structure with a single or multiple energy extraction units.
- The central hub refers to the configuration where the blades are attached radially to the rotor shaft. In central hub configurations the hub is considered to transmit the loads from the blades to the rotor shaft.
- This standard considers positively, neutral, negatively and variable buoyancy turbines.
- With multi-bladed either single or multiple rotors. Multiple rotors implies a common PTO unit per turbine and multiple turbines implies independent PTO units.
- The yaw system can be either fixed or active or free. The yaw systems, considered in this standard, are defined as the combination of the possible sub-systems that are part of them, as indicated in the following Table 1-1.

Table 1-1 Yaw System Description

Yaw system type	Sub systems					
	Power	Rotating mechanism	Control	Structural locking mech.	Structural load bearing	Cable management
Fixed	x	x	x	✓	x	x
Active	✓	✓	✓	✓	✓	✓
Free	x	✓	x	✓	✓	✓
	x	✓	x	x	✓	✓

Description of sub systems is provided below:

- a) Power: Indication that some sort of power (mainly electrical) needs to be provided to the yaw system

- b) Rotating mechanism: Existence of a mechanism (mechanic or hydraulic, but not limited to) dedicated to rotate the nacelle to be aligned with the current flow direction.
 - c) Control: Indication of any sort of system controlling the yaw system and its operation.
 - d) Structural locking mechanism: Mechanism to fix the nacelle to the support structure and prevent it from rotating during operation.
 - e) Structural load bearing: A bearing to transmit the structural loads from the nacelle to the support structure
 - f) Cable management: A system dedicated to avoid cable twisting due to rotation e.g. slip rings
- The HATT considered in this standard consists of the rotor, the machine house (nacelle), the support structure, the foundation and all components associated / attached within the HATT. HATT array includes furthermore array cabling and transforming substation.
 - Blades considered in this standard are Buoyant Blades, Semi-Flooded Blades, Flooded Blades and Non-Buoyant Blades.
 - Tidal turbines are in general designed to yield a power output through a range of current speeds. For current speeds over a certain magnitude it is necessary to discharge part of the excess energy to avoid damage to the tidal turbine. Thus, the tidal turbine needs some sort of power control. There are three types of power control considered in this standard: pitch, stall and over-speed.
 - a) Pitch: Pitch-controlled tidal turbines have blades that can be pitched out of the flow to an angle where the blade chord is parallel to the current direction and thus, reduce the loading.
 - b) Stall: Stall-controlled tidal turbines have their rotor blades bolted to the hub at a fixed angle. The stall phenomenon is used to limit the power output when the current speed becomes too high. This is achieved by designing the geometry of the rotor blade in such a way that flow separation is created in the downstream side of the blade when the current speed exceeds some chosen critical value.
 - c) Over-speed: Where rotor tip-speeds are deliberately operated in excess of the optimum tip-speed for maximum power extraction to reduce torque within the drivetrain (via increased tip-speed). Figure 1-1 illustrates this power control option.
 - In respect of the operating principles of pitch-controlled tidal turbines a distinction is made between:
 - d) individual pitch operation, which adjusts the pitch angle of every single rotor blade independently
 - e) collective pitch operation, which adjusts pitch angles simultaneously and equally at all blades (either at every single blade independently or non-independently).
 - This standard considers both pitch-controlled hydraulically and electrically activated systems. The configuration of the systems can be fixed (i.e. static pitch blades) or variable (either collectively or individually pitching blades).

- This standard considers the following types of speed control for single units: fixed-speed turbine and single variable controlled-speed turbine; and the following types in the case of HATT arrays: multiple independent variable controlled-speed turbines and collective speed-controlled turbines.
- Shrouded turbines are NOT considered in this standard.

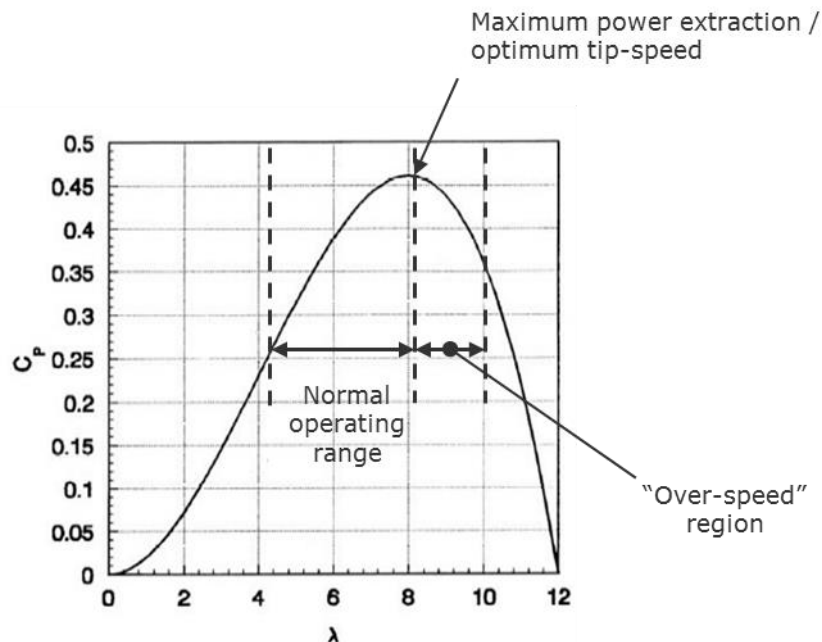



Figure 1-1 Typical Power Coefficient (C_p) vs. Tip-Speed (λ) Graph

- This standard considers the following configurations of the drivetrain: gearbox, direct drive, hydraulic and hybrid. All mentioned configurations are considered for both dry and wet (directly exposed to sub-sea environment) conditions.
- Tidal turbines require a braking mechanism for emergency purposes or for operating purposes. This standard considers: generator braking (either power ramp down during shut down or by short-circuiting during stand still), braking on shaft (either high speed shaft or low speed shaft), disruption to hydrodynamic loading on blade(s) and locking mechanism.
- This standard considers the following configurations of electrical equipment including switch gear, generator, transformer and frequency converter:
 - a) sub-sea - integral within turbine
 - b) sub-sea - external to turbine
 - c) shore-based
 - d) surface-piercing platform
 - e) multiple turbines (i.e. array of HATTs) switch-gearing.
- This standard covers the specification of attachment of cables and subsea connections to structure and the account for Vortex Induced Vibrations (VIV).
- Marine operations are a critical aspect of the tidal turbine deployment and retrieval. within this standard, use of following methods / equipment is covered:
 - a) towing of turbine / lifting / launching

- 
- b) external (i.e. removable / retrievable) winch mechanism
 - c) integral winch mechanism
 - d) automated winch mechanism
 - e) use of floating crane
 - f) ballasted buoyant turbine
 - g) ballasted buoyant cradle
 - h) guide wires
 - i) divers
 - j) Remotely Operated Vehicle (ROV).

This standard considers hard wired safety chain safety system and safety related control system. In both cases the safety systems are independent of the control system for normal operation.

Items from the list above provide coverage for generic configurations within the tidal turbine field. Where particular configuration specifications fall outside of these generic boundaries they will be covered outside of the general requirements for certification, with each feature being considered on a case-by-case basis.

This standard gives requirements for the following:

- design principles
- selection of material and extent of inspection in manufacturing yard
- design loads
- load effect analyses
- load combinations
- structural design
- machinery design
- electrical system
- control and instrumentation
- corrosion protection
- manufacturing and testing of systems and components
- transport and installation
- commissioning
- in-service inspection, maintenance and monitoring
- power performance.

Impact in the aspects above due to array configuration is addressed in this standard. However, this is based on limited data and no field experience.

Guidance on risk assessment is provided. HATT that have aspects not included in [1.3] are to be risk assessed as described based on the risk assessment approach described here.

1.4 Non-DNV GL codes

In case of any conflict between the requirements of this standard and a reference document other than DNV GL documents, the requirements of this standard shall prevail.

The provision for using non-DNV GL codes or standards is that the same safety level as the one resulting for designs according to this standard is obtained.

Where reference in this standard is made to codes other than DNV GL documents, the valid revision of these codes shall be taken as the revision which was current at the date of issue of this standard, unless otherwise noted.

When code checks are performed according to other codes than DNV GL codes, the resistance and material factors as given in the respective codes shall be used.

Where applicable, national and governmental regulations may override the requirements of this standard.

1.5 Equivalence and future developments

This standard specifies requirements for the design of HATTs to ensure a safety level that is deemed acceptable for such devices. Some of these requirements imply certain constraints on structural designs that reflect the current practice in the industry and established principles of design and construction of HATTs. Alternative designs and arrangements that deviate from these requirements may be accepted provided that it is documented that the level of safety is at least as high as that implied by the requirements of this standard. A basic premise for such analyses should be that all cost effective risk control options have been implemented. Reference is made to [1.10] and the process described in DNV-OSS-312.

The specific requirements of this standard reflect what was deemed cost effective means of managing the risks associated with HATT at the time of issue of this standard. Technology developments after that point in time may provide new means of cost effective risk reduction. Should relevant cost benefit assessment show that use of such new technology would provide cost effective risk reduction, such new technology should be implemented on HATT where risk assessment indicates it fits.

1.6 References

The documents listed in Table 1-3, Table 1-4, Table 1-4 and Table 1-5 and the recognized codes and standards in Table 1-6 are referred to in this standard.

The latest valid revision of each of the DNV GL, legacy DNV and legacy GL reference documents in in Table 1-3, Table 1-4, Table 1-4 and Table 1-5 applies.

Table 1-2 DNV GL Recommended Practices

<i>Reference</i>	<i>Title</i>
DNVGL-RP-0005	RP-C203: Fatigue design of offshore steel structures

Table 1-3 Legacy DNV Offshore Service Specifications, Standards, Offshore Standards, Rules for Classification and Rules for Certification

<i>Reference</i>	<i>Title</i>
DNV-OSS-312	Certification of Tidal and Wave Energy Converters
DNV-DS-J102	Design and Manufacture of Wind Turbine Blades
DNV-OS-B101	Metallic Materials
DNV-OS-C401	Fabrication and Testing of Offshore Structures
DNV-OS-C501	Composite Components

Table 1-3 Legacy DNV Offshore Service Specifications, Standards, Offshore Standards, Rules for Classification and Rules for Certification

<i>Reference</i>	<i>Title</i>
DNV-OSS-312	Certification of Tidal and Wave Energy Converters
DNV-OS-C502	Offshore Concrete Structures
DNV-OS-D101	Marine and Machinery Systems and Equipment
DNV-OS-D201	Electrical Installations
DNV-OS-H101	Marine Operations, General
DNV-OS-J101	Design of Offshore Wind Turbine Structures
DNV-OS-J201	Offshore substations for wind farms
	Rules for Ships Part 4 Chapter 6 Piping Systems

Table 1-4 Legacy DNV Recommended Practices and Classification Notes

<i>Reference</i>	<i>Title</i>
DNV-RP-A203	Qualification of New Technology
DNV-RP-B401	Cathodic Protection Design
DNV-RP-C201	Buckling Strength of Plated Structures
DNV-RP-C202	Buckling Strength of Shells
DNV-RP-C205	Environmental Conditions and Environmental Loads
DNV-RP-G101	Risk Based Inspection of Offshore Topsides Static Mechanical Equipment
DNV-RP-H101	Risk Management in Marine and Subsea Operations
Classification Notes No. 30.4	Foundations
Classification Notes No. 30.7	Fatigue Assessment of Ship Structures
Classification Notes No. 41.5	Calculation of Marine Propellers

Table 1-5 Legacy GL Rules and Guidelines

<i>Reference</i>
GL Rules for Classification and Construction - I Ship technology - Part 5 "Underwater Technology", Chapter 3 "Unmanned Submersibles (ROV, AUV) and Underwater Working Machines"
GL Rules for Classification and Construction - III Naval Ship Technology - Part 1 "Surface Ships", Chapter 2 "Propulsion Plants"
GL Rules for Classification and Construction IV – Industrial Services, Part 2 – GL Guideline for the Certification of Condition Monitoring Systems for Wind Turbines Edition 2013
GL Rules for Classification and Construction IV – Industrial Services, Part 7 – Offshore Substations, Edition 2013
GL Rules for Classification and Construction IV – Industrial Services, Part 2 – GL Guidelines for the certification of Offshore Wind Turbines, Edition 2012
GL Technical Publication "Recommendations for Rudder Design Preventive Measures to Decrease or Avoid Rudder Cavitation"

Table 1-6 Other references

<i>Reference</i>	<i>Title</i>
	AISC LRFD Manual of Steel Construction
ASME B31.3	Process Piping
ASTM A320	Standard Specification for Alloy-Steel and Stainless Steel Bolting for Low-Temperature Service
ASTM C273	Standard Test Method for Shear Properties of Sandwich Core Materials
ASTM C297	Standard Test Method for Flatwise Tensile Strength of Sandwich Constructions
ASTM C393	Standard Test Method for Core Shear Properties of Sandwich Constructions by Beam Flexure
ASTM D5528	Standard Test Method for Mode I Interlaminar Fracture Toughness of Unidirectional Fiber-Reinforced Polymer Matrix Composites

Table 1-6 Other references

<i>Reference</i>	<i>Title</i>
ASTM D5868	Standard Test Method for Lap Shear Adhesion for Fiber Reinforced Plastic (FRP) Bonding
ASTM D6641	Standard Test Method for Compressive Properties of Polymer Matrix Composite Materials Using a Combined Loading Compression (CLC) Test Fixture
ASTM D7078	Standard Test Method for Shear Properties of Composite Materials by V Notched Rail Shear Method
BGI 753	SF6-Anlagen und -Betriebsmittel
BGV A8	Sicherheits- und Gesundheitsschutzkennzeichnung am Arbeitsplatz
BS 7910	Guide to methods for assessing the acceptability of flaws in metallic structures
CIGRE TB490	Recommendations for Testing of Long AC Submarine Cables with Extruded Insulation for System Voltage above 30 (36) to 500 (550) kV
DIN 3990-4	Calculation of load capacity of cylindrical gears; introduction and general influence factors
DIN 53292	Testing of sandwiches; Tensile test perpendicular to the faces
DIN 53294	Testing of sandwiches; Shear test
DIN 53752	Testing of plastics; determination of the coefficient of linear thermal expansion
DIN 6892	Drive type fastenings without taper action - Parallel keys - Calculation and design
DIN 7190	Interference fits - Calculation and design rules
DIN 743	Calculation of load capacity of shafts and axles
DIN EN ISO 6721-5	Plastics -- Determination of dynamic mechanical properties -- Part 5: Flexural vibration -- Non-resonance method
DIN EN ISO IEC 17020	Conformity assessment - General criteria for the operation of various types of bodies performing inspection
DIN EN ISO IEC 17025	General requirements for the competence of testing and calibration laboratories
DIN EN ISO IEC 45011	Replaced by ISO IEC 17065:2012 Conformity assessment - Requirements for bodies certifying products, processes and services
Electra No. 189	Recommendations for tests on power transmission DC cables for rated voltage up to 800 kV
Electra No. 206	Testing DC extruded cable systems for Power Transmission up to 250 kV
Electra No. 218	Addendum to "Recommendations for tests of power transmission DC cables up to 800 kV"
Electra TB No. 219	Recommendations for testing DC extruded cable systems for power transmission at a rated voltage up to 250 kV
EN 10204 (ISO 10474)	Metallic products - Types of inspection documents
EN 1993-1-6	Eurocode 3: Design of steel structures - Part 1-6: Strength and stability of shell structures
EN 50160	Voltage characteristics of electricity supplied by public electricity networks
EN 60909	Short-circuit currents in three-phase a.c. systems
EquiMar Project Deliverable 2.3	Application of Numerical Models
EquiMar Project Deliverable 4.2	Data Analysis and Presentation to Quantify Uncertainty
EquiMar Project Deliverable 2.2	Wave and Tidal Resource Characterisation
EquiMar Project Deliverable 2.3	Numerical models
EquiMar Project Deliverable 2.7	Protocols for wave and tidal resource assessment
Eurocode 3 EN 1993-1-1	Eurocode 3: Design of steel structures - Part 1-1: General rules and rules for buildings
Eurocode 7	Geotechnical design
Eurocode 8-5	Design of structures for earthquake resistance - Part 5: Foundations, retaining structures and geotechnical aspects
IEC 60034	Rotating electrical machines

Table 1-6 Other references

<i>Reference</i>	<i>Title</i>
IEC 60034-1	Rotating electrical machines - Part 1: Rating and performance
IEC 60034-14	Rotating electrical machines - Part 14: Mechanical vibration of certain machines with shaft heights 56 mm and higher - Measurement, evaluation and limits of vibration severity
IEC 60034-16-3	Rotating electrical machines -- Part 16-3: Excitation systems for synchronous machines - Dynamic performance
IEC 60068	Environmental testing
IEC 60076	Power transformers
IEC 60076-1	Power transformers - Part 1: General
IEC 60076-11	Power transformers - Part 11: Dry-type transformers
IEC 60076-16	Power transformers - Part 16: Transformers for wind turbine applications
IEC 60099-1	Surge arresters – Part 1: Non-linear resistor type gapped surge arresters for a.c. systems
IEC 60099-4	Surge arresters – Part 4: Metal-oxide surge arresters without gaps for a.c. systems
IEC 60112	Method for the determination of the proof and the comparative tracking indices of solid insulating materials
IEC 60204-1	Safety of machinery - Electrical equipment of machines - Part 1: General requirements
IEC 60204-11	Safety of machinery - Electrical equipment of machines - Part 11: Requirements for HV equipment for voltages above 1 000 V a.c. or 1 500 V d.c. and not exceeding 36 kV
IEC 60227	Polyvinyl chloride insulated cables of rated voltages up to and including 450/750 V
IEC 60228	Conductors of insulated cables
IEC 60269	Low-voltage fuses
IEC 60282-1	High-voltage fuses - Part 1: Current-limiting fuses
IEC 60287	Electric cables - Calculation of the current rating
IEC 60364	Low-voltage electrical installations
IEC 60364-5-52	Low-voltage electrical installations - Part 5-52: Selection and erection of electrical equipment - Wiring systems
IEC 60364-6	Low-voltage electrical installations - Part 6: Verification
IEC 60502	Power cables with extruded insulation and their accessories for rated voltages from 1 kV ($U_m = 1.2$ kV) up to 30 kV ($U_m = 36$ kV)
IEC 60721	Classification of environmental conditions
IEC 60721-3-3	Classification of environmental conditions - Part 3-3: Classification of groups of environmental parameters and their severities - Stationary use at weatherprotected locations
IEC 60840	Power cables with extruded insulation and their accessories for rated voltages above 30 kV ($U_m = 36$ kV) up to 150 kV ($U_m = 170$ kV) – Test methods and requirements
IEC 60947	Low-voltage switchgear and controlgear
IEC 60947-5-5	Low-voltage switchgear and controlgear - Part 5-5: Control circuit devices and switching elements - Electrical emergency stop device with mechanical latching function
IEC 61000-4-30	Electromagnetic compatibility (EMC) - Part 4-30: Testing and measurement techniques - Power quality measurement methods
IEC 61082	Preparation of documents used in electrotechnology
IEC 61400-12-1	Wind turbines - Part 12-1: Power performance measurements of electricity producing wind turbines
IEC 61400-21	Wind turbines - Part 21: Measurement and assessment of power quality characteristics of grid connected wind turbines
IEC 61400-23	Wind turbines - Part 23: Full-scale structural testing of rotor blades
IEC 61400-24	Wind turbine generator systems - Part 24: Lightning protection
IEC 61439-1	Low-voltage switchgear and controlgear assemblies - Part 1: General rules
IEC 61643-12	Low-voltage surge protective devices – Part 12: Surge protective devices connected to low-voltage power distribution systems – Selection and application principles

Table 1-6 Other references

<i>Reference</i>	<i>Title</i>
IEC 61643-22	Low-voltage surge protective devices - Part 21: Surge protective devices connected to telecommunications and signalling networks – Selection and application principles
IEC 61800-1	Adjustable speed electrical power drive systems - Part 1: General requirements - Rating specifications for low voltage adjustables speed d.c. power drive systems
IEC 61800-2	Adjustable speed electrical power drive systems - Part 2: General requirements - Rating specifications for low voltage adjustable frequency a.c. power drive systems
IEC 61800-3	Adjustable speed electrical power drive systems - Part 3: EMC requirements and specific test methods
IEC 61800-4	Adjustable speed electrical power drive systems - Part 4: General requirements - Rating specifications for a.c. power drive systems above 1 000 V a.c. and not exceeding 35 kV
IEC 61800-6	Adjustable speed electrical power drive systems - Part 6: Guide for determination of types of load duty and corresponding current ratings
IEC 61892-2	Mobile and fixed offshore units - Electrical installations - Part 2: System design
IEC 61892-3	Mobile and fixed offshore units - Electrical installations - Part 3: Equipment
IEC 62061	Safety of machinery - Functional safety of safety-related electrical, electronic and programmable electronic control systems
IEC 62067	Power cables with extruded insulation and their accessories for rated voltages above 150 kV ($U_m = 170$ kV) up to 500 kV ($U_m = 550$ kV) – Test methods and requirements
IEC 62124	Photovoltaic (PV) stand alone systems - Design verification
IEC 62271	High-voltage switchgear and controlgear
IEC 62305	Protection against lightning
IEC 62305-1	Protection against lightning - Part 1: General principles
IEC 62305-3	Protection against lightning - Part 3: Physical damage to structures and life hazard
IEC 62305-4	Protection against lightning - Part 4: Electrical and electronic systems within structures
IEC 62477-1	Safety requirements for power electronic converter systems and equipment - Part 1: General
IEC 62600-2	(DRAFT) Marine energy - Wave, tidal and other water current converters - Part 2: Design requirements for marine energy systems
IEC 62600-200	Marine energy - Wave, tidal and other water current converters - Part 200: Electricity producing tidal energy converters - Power performance assessment
IEC 82079	Preparation of instructions for use - Structuring, content and presentation
IEC 82079-1	Preparation of instructions for use - Structuring, content and presentation - Part 1: General principles and detailed requirements
IEC TR 60721-4-3	Classification of environmental conditions - Part 4-3: Guidance for the correlation and transformation of environmental condition classes of IEC 60721-3 to the environmental tests of IEC 60068 - Stationary use at weatherprotected locations
IEC 61400-13	Measurement of mechanical loads
ISO 10474	Steel and steel products -- Inspection documents
ISO 1172	Textile-glass-reinforced plastics - Prepregs, moulding compounds and laminates - Determination of the textile-glass and mineral-filler content - Calcination methods
ISO 1219-2	Fluid power systems and components - Graphical symbols and circuit diagrams - Part 2: Circuit diagrams
ISO 1328-1	Cylindrical gears -- ISO system of flank tolerance classification -- Part 1: Definitions and allowable values of deviations relevant to flanks of gear teeth
ISO 13849-1	Safety of machinery - Safety-related parts of control systems - Part 1: General principles for design
ISO 13850	Safety of machinery - Emergency stop - Principles for design

Table 1-6 Other references

<i>Reference</i>	<i>Title</i>
ISO 14126	Fibre-reinforced plastic composites - Determination of compressive properties in the in-plane direction
ISO 14635-1	Gears -- FZG test procedures -- Part 1: FZG test method A/8,3/90 for relative scuffing load-carrying capacity of oils
ISO 175	Plastics - Methods of test for the determination of the effects of immersion in liquid chemicals
ISO 179	Plastics -- Determination of Charpy impact properties
ISO 1940-1	Mechanical vibration -- Balance quality requirements for rotors in a constant (rigid) state -- Part 1: Specification and verification of balance tolerances
ISO 19901-1	Petroleum and natural gas industries -- Specific requirements for offshore structures -- Part 1: Metocean design and operating considerations
ISO 19901-2	Petroleum and natural gas industries - Specific requirements for offshore structures - Part 2: Seismic design procedures and criteria
ISO 19901-8	Petroleum and natural gas industries -- Specific requirements for offshore structures -- Part 8: Marine soil investigations
ISO 19902	Petroleum and natural gas industries - Fixed steel offshore structures
ISO 22475-1	Geotechnical investigation and testing - Sampling methods and groundwater measurements - Part 1: Technical principles for execution
ISO 281	Rolling bearings -- Dynamic load ratings and rating life
ISO 291	Plastics - Standard atmospheres for conditioning and testing
ISO 3521	Plastics -- Unsaturated polyester and epoxy resins -- Determination of overall volume shrinkage
ISO 4413	Hydraulic fluid power - General rules and safety requirements for systems and their components
ISO 4587	Adhesives -- Determination of tensile lap-shear strength of rigid-to-rigid bonded assemblies
ISO 4624	Paints and varnishes - Pull-off test for adhesion
ISO 527	Plastics - Determination of tensile properties
ISO 527-4	Plastics - Determination of tensile properties - Part 4: Test conditions for isotropic and orthotropic fibre-reinforced plastic composites
ISO 527-5	Plastics - Determination of tensile properties - Part 5: Test conditions for unidirectional fibre-reinforced plastic composites
ISO 62	Plastics -- Determination of water absorption
ISO 6270-1	Paints and varnishes -- Determination of resistance to humidity -- Part 1: Continuous condensation
ISO 6336	Calculation of load capacity of spur and helical gears
ISO 6336-1	Calculation of load capacity of spur and helical gears -- Part 1: Basic principles, introduction and general influence factors
ISO 6336-2	Calculation of load capacity of spur and helical gears -- Part 2: Calculation of surface durability (pitting)
ISO 6336-3	Calculation of load capacity of spur and helical gears -- Part 3: Calculation of tooth bending strength
ISO 6336-5	Calculation of load capacity of spur and helical gears -- Part 5: Strength and quality of materials
ISO 6336-6	Calculation of load capacity of spur and helical gears -- Part 6: Calculation of service life under variable load
ISO 7010	Graphical symbols - Safety colours and safety signs - Registered safety signs
ISO 75-2	Plastics -- Determination of temperature of deflection under load -- Part 2: Plastics and ebonite
ISO 76	Rolling bearings -- Static load ratings
ISO 898	Mechanical Properties of Fasteners
ISO 9000	Quality management systems - Fundamentals and vocabulary
ISO 9001	Quality management systems - Requirements
ISO 9004	Managing for the sustained success of an organization - A quality management approach
ISO 9227	Corrosion tests in artificial atmospheres -- Salt spray tests
ISO 9664	Adhesives - Test methods for fatigue properties of structural adhesives in tensile shear

Table 1-6 Other references

<i>Reference</i>	<i>Title</i>
ISO/TR 13989	Calculation of scuffing load capacity of cylindrical, bevel and hypoid gears
ISO/TS 16281	Rolling bearings -- Methods for calculating the modified reference rating life for universally loaded bearings
NORSOK G-001	Marine soil investigations
NORSOK N-004	Design of steel structures
VDE 0101	Power installations exceeding AC 1 kV
VDI 2230	Systematic calculation of high duty bolted joints

1.7 Definitions

1.7.1 Verbal forms

Shall: Indicates a mandatory requirement to be followed for fulfilment or compliance with the present standard. Deviations are not permitted unless formally and rigorously justified, and accepted by all relevant contracting parties.

Should: Indicates a recommendation that a certain course of action is preferred or is particularly suitable. Alternative courses of action are allowable under the standard where agreed between contracting parties, but shall be justified and documented.

May: Indicates a permission, or an option, which is permitted as part of conformance with the standard.

Can: Requirements with can are conditional and indicate a possibility to the user of the standard.

Agreement, or by agreement: Unless otherwise indicated, agreed in writing between contractor and purchaser.

1.7.2 Terms

O-Series: Means the first batch of a serial production

Abnormal load: Load resulting from one of a number of severe fault situations for the turbine, which result in activation of system protection functions. Abnormal loads are in general less likely to occur than loads from any of the normal load cases considered for the ULS.

Accidental Limit States (ALS): Ensure that the structure resists accidental loads and maintain integrity and performance of the structure due to local damage or flooding.

Activation power: Instantaneous active electrical power at the output terminals of HATT at which immediate triggering of the safety system must occur.

Activation rotational speed (n_A): Rotational speed at which immediate triggering of the safety system must occur.

Assessment: Means the systematic collection, review and use of information or data in demonstrating that specified requirements relating to the product (or process, system, person or body) have been fulfilled.

ALARP: As low as reasonably practicable; notation used for risk.

Atmospheric zone: The external region exposed to atmospheric conditions.

Blockage: The effects of the boundaries on the flow around a body.

Certification: Action by a certification body, providing written assurance that adequate confidence is provided that a duly identified product is demonstrably in conformity with a specific standard or other normative document.



Certification Basis: Requirements for the system's specifications, operating conditions, performance and reliability targets. The basis to which the system will be assessed during certification.

Certification Plan: created at the conclusion of the Definition Phase. This will include the standards and certification levels agreed upon for the components and sub-systems, and the testing plan as defined by the Qualification Methods. The document contains the plan for all actions to be carried out during the certification process.

Characteristic load: The reference value of a load to be used in the determination of the design load. The characteristic load is normally based upon a defined quantile in the upper tail of the distribution function for load.

Characteristic load effect: The reference value of a load effect to be used in the determination of the design load effect. The characteristic load effect is normally based upon a defined quantile in the upper tail of the distribution function for load effect.

Characteristic resistance: The reference value of a structural strength to be used in the determination of the design resistance. The characteristic resistance is normally based upon a 5% quantile in the lower tail of the distribution function for resistance.

Characteristic material strength: The nominal value of a material strength to be used in the determination of the design strength. The characteristic material strength is normally based upon a 5% quantile in the lower tail of the distribution function for material strength.

Characteristic value: A representative value of a load variable or a resistance variable. For a load variable, it is a high but measurable value with a prescribed probability of not being unfavourably exceeded during some reference period. For a resistance variable it is a low but measurable value with a prescribed probability of being favourably exceeded.

Conceptually feasible: A technology at an early stage of development is considered conceptually feasible if the main challenges have been identified and judged to be resolvable by use of sound engineering practice. Although a technology has been stated conceptually feasible, there are still activities necessary to be executed in order to prove that the technology is fit for service. Consequently, there is a possibility that the technology, contrary to expectations, will not be stated fit for service.

Classification Notes: The classification notes cover proven technology and solutions which are found to represent good practice by DNV GL, and which represent one alternative for satisfying the requirements stipulated in the DNV GL Rules or other codes and standards cited by DNV GL. The classification notes will in the same manner be applicable for fulfilling the requirements in the legacy DNV offshore standards.

Critical part: Means a part of the structure, systems, subsystems or components that is identified by standards and / or risk assessment as having an essential or important role within the integrity of the local overall function of the product. The failure of a Critical Part is normally associated with a high risk.

Current: A flow of water past a fixed point and usually represented by a velocity and a direction.

Current shear: Variation of current speed across a plane perpendicular to the tidal direction.

Current shear law: Current profile; mathematical expression for current speed variation with depth below sea surface.



Cut-in current speed: Lowest mean current speed at hub height at which a turbine produces power.

Cut-out current speed: Highest mean current speed at hub height at which a turbine is designed to produce power.

Cut-out rotational speed (n_4): Rotational speed at which gentle shut-down of the turbine performed by the control system shall take place.

Cut-out yaw error: The largest admissible yaw error above which HATT must be gently shut-down by the control system.

Definition Phase: Characterised by all the initial activities covering the definition of the technology its objectives and limits as well as risks leading to the Certification Plan.

Deployment: Means all marine operations leading to the final positioning of the turbine (including supporting structure) at site.

Design Basis: Means the fundamental design principles and standards used in the generation of the design.

Design temperature: The lowest daily mean temperature that the structure may be exposed to during installation and operation.

Design value: The value to be used in the deterministic design procedure, i.e. characteristic value modified by the resistance factor or the load factor, whichever is applicable.

Ebb: Period from high tide to low tide when the water level falls.

Environmental state: Short term condition of typically 10 minutes, 1 hour or 3 hours duration during which the intensities of environmental processes such as wave, tidal and wind processes can be assumed to be constant, i.e. the processes themselves are stationary.

Expected loads and response history: Expected load and response history for a specified time period, taking into account the number of load cycles and the resulting load levels and response for each cycle.

Expected value: The mean value, e.g. the mean value of a load during a specified time period.

Failure: Termination of the ability of an item to perform the required (specified) function.

Fatigue Limit States (FLS): Related to the possibility of failure due to the cumulative damage effect of cyclic loading.

Fit for service: A technology is considered fit for service when the failure modes that have been identified through the systematic process outlined in the DNV-OSS-312 have been properly addressed, and the supporting evidence substantiates that the technology fulfils all stated functional requirements and meets the stated reliability target. Although a technology has been stated fit for service, the technology has not necessarily an in-service record that eliminates the possibility for failures due to unidentified or misjudged failure modes. Consequently, there will be a possibility that the technology, contrary to expectations, will fail in-service.

Flood: Period from low tide to high tide when the water level rises.

Foundation: The foundation of a support structure for a tidal turbine is in this document reckoned as a structural or geotechnical component, or both, extending from the seabed downwards.



Grid loss / grid disturbances: Deviations from the normal conditions in grid voltage and / or frequency. Depending on the electrical parameters defined in a site-specific manner, the control system decides whether a grid disturbance or a grid loss has occurred and undertakes correspondent action.

Guidance: Means advice that is not mandatory but with which, in light of general experience, recommends compliance.

Guidance note: Information in the standards in order to increase the understanding of the requirements.

Harmonic analysis: A type of analysis for the prediction of tidal elevation and currents that assumes that tidal motion, generated by periodic differential gravitational forces, can be represented by the sum of a series of simple harmonic terms (tidal constituents) with each term being represented by an oscillation at a known frequency of astronomical origin.

H_s: Significant Wave Height – the mean wave height (trough to crest) of the highest 1/3 of waves.

High frequency: Frequency band relating to fast-varying responses. Turbulence and blade passing are high frequency events. Wave frequencies are also included in this category.

Highest astronomical tide (HAT): Level of high tide when all harmonic components causing the tide are in phase.

Hindcast: A method using registered meteorological data to reproduce environmental parameters.

Hub height: Height of centre of swept area of turbine rotor, measured from mean seabed level.

Idling: Condition of a tidal turbine, which is rotating slowly and not producing power.

Inspection: Means quantitative activities such as measurement, examination, testing or gauging of one or more characteristics of an object or service, and comparing results with specified requirements to determine conformity.

Limit States: Means a condition beyond which the applied stresses within a structure (or structural elements) exceed a specified design limit.

Load effect: Effect of a single design load or combination of loads on the equipment or system, such as stress, strain, deformation, displacement, motion, etc.

Low frequency: Frequency band relating to slowly varying responses with frequencies below the typical wave frequency range. Example of such slowly varying responses is the tidal cycle related to ebb and flow.

Lowest astronomical tide (LAT): Level of low tide when all harmonic components causing the tide are in phase.

Lowest daily mean temperature: The lowest value of the annual daily mean temperature curve for the area in question. For seasonally restricted service the lowest value within the time of operation applies.

Maximum operating speed (n₃): Rotor speed, within which the rotational speed lies under normal operating conditions.

Maximum overspeed (n_{max}): Rotor speed, which never may be exceeded even briefly.



Mean: Statistical mean over observation period.

Mean water level (MWL): Mean still water level, defined as mean level between highest astronomical tide and lowest astronomical tide.

Mean zero-upcrossing period: Average period between two consecutive zero-upcrossings of ocean waves in a sea state.

Metoccean: Abbreviation of meteorological and oceanographic.

Misalignment: Current and wave misalignment is a term which designates that the current and the waves at a given point in time and space are not co-directional, i.e. they act or propagate in different directions. Misalignment is also used as a term for the deviation between mean current direction and rotor axis.

New technology: Technology that is not proven, no track record. The failure modes and mechanisms of failure are not known or there is limited understanding on how the technology can fail and the safety margins to failures. The technology has large uncertainties.

Non-destructive testing (NDT): Tests and inspection of structures by visual inspection, radiographic testing, ultrasonic testing, magnetic particle testing, penetrant testing and other non-destructive methods for revealing defects and irregularities.

Offshore Standard: The legacy DNV offshore standards are documents which present the principles and technical requirements for design of offshore structures. The standards are offered as DNV GL's interpretation of engineering practice for general use by the offshore industry for achieving safe structures.

Operating conditions: Conditions wherein a unit is on location for purposes of drilling or other similar operations, and combined environmental and operational loadings are within the appropriate design limits established for such operations. The unit may be either afloat or supported by the sea bed, as applicable.

Over-power: Is the active electrical power at the output terminals of HATT at which control system must initiate power reduction.

Parking: The condition to which a tidal turbine returns after a normal shutdown. Depending on the construction of the tidal turbine, parking refers to the turbine being either in a stand-still or an idling condition.

Partial Safety Factor Method: Method for design where uncertainties in loads are represented by a load factor and uncertainties in strengths are represented by a material factor.

Pile head: The position along a foundation pile in level with the seabed. This definition applies regardless of whether the pile extends above the seabed.

Pile length: Length along a pile from pile head to pile tip.

Pile penetration: Vertical distance from the seabed to the pile tip.

Power Take-Off: The power take-off subsystem is where the mechanical motion is converted to electricity.

Power-Plant: Means the top-level assembly of the HATT structure, machinery and associated equipment utilised directly in the generation of electrical energy from tidal power.

Proven technology: In the field, proven technology has a documented track record for a defined environment. Such documentation shall provide confidence in the technology from practical



operations, with respect to the ability of the technology to meet the specified requirements. Technology has been used in the industry for many years with modes of failure and failure mechanisms identified and controlled by design, fabrication, testing and maintenance requirements provided in standards or industry practice.

Qualification Methods: Actions identified during the Definition Phase to deal with uncertainties and significant risks.

Rated power: Quantity of power assigned, generally by a manufacturer, for a specified operating condition of a component, device or equipment. For a HATT, the rated power is the maximum continuous electrical power output (active power) which a turbine is designed to achieve under normal operating conditions. (Following a possible inverter system and before a possible transformer)

Rated current speed: Minimum current speed at hub height at which a tidal turbine's rated power is achieved in the case of a steady current without turbulence.

Rated rotor speed: Rotational speed at the rated current speed

Reaction System: See "Support Structure"

Recommended Practice (RP): The recommended practice publications cover proven technology and solutions which have been found by DNV GL to represent good practice, and which represent one alternative for satisfying the requirements stipulated in the legacy DNV offshore standards or other codes and standards cited by DNV GL.

Redundancy: The ability of a component or system to maintain or restore its function when a failure of a member or connection has occurred. Redundancy can be achieved for instance by strengthening or introducing alternative load paths.

Refraction: Process by which wave energy is redistributed as a result of changes in the wave propagation velocity caused by variations in the water depth.

Reliability: The ability of a component or a system to perform its required function without failure during a specified time interval.

Residual currents: All other components of a current than tidal current.

Retrieval: Means all marine operations leading to the return of the turbine to either a maintenance or decommissioning site.

Risk: Means the qualitative or quantitative likelihood of an accident or unplanned event occurring, considered in conjunction with the potential consequences of such an event. In quantitative terms, risk is the quantified probability of a defined failure mode multiplied by its quantified consequence.

Risk reduction measures: Those measures taken to reduce the risks during the operation of the technology and to the health and safety of personnel associated with it or in its vicinity by reduction in the probability of failure and / or mitigation of the consequences of failure.

Scour zone: The external region of the unit which is located at the seabed and which is exposed to scour.

Serviceability Limit States (SLS): Imply deformations in excess of tolerance without exceeding the load-carrying capacity, i.e., they correspond to tolerance criteria applicable to normal use.



Slamming: Impact load on an approximately horizontal member from a rising water surface as a wave passes. The direction of the impact load is mainly vertical.

Specified value: Minimum or maximum value during the period considered. This value may take into account operational requirements, limitations and measures taken such that the required safety level is obtained.

Splash zone: External or internal surfaces of a structure which are intermittently wetted by tide or waves or both.

Standstill: The condition of a tidal turbine generator system that is stopped.

Submerged zone: The part of the installation which is below the splash zone, including the scour zone and permanently buried parts.

Standard: Means a document that provides guidance for the design, construction, deployment and in-service life of a product together with principles and technical requirements which must be observed in order to achieve specified levels of safety and reliability. A Standard provides the minimum basis for certification.

Support Structure: Means the structural interface between the HATT and the foundation (e.g. stand or tripod)

Survey: Means a systematic and independent examination of structures, materials, components or systems in order to verify compliance with the standards and / or statutory requirements.

Survival condition: A condition during which a unit may be subjected to the most severe environmental loadings for which the unit is designed. Operation of the unit may have been discontinued due to the severity of the environmental loadings.

Target safety level: A nominal acceptable probability of structural failure.

Technology - Degrees of Novelty: The level of novelty and maturity are normally classified as Proven, Limited history and New or Unproven. The degree of technology novelty combined where / how the technology is applied (Application Area) will be classified in categories to be used as input to a risk assessment.

Technology qualification: A confirmation by examination and provision of evidence that the new technology meets the specified requirements for the intended use. Hence, qualification is a documented set of activities to prove that the technology is fit for service.

Technology with limited field history: Technology that has been used to a limited range of applications and conditions. The technology has limited statistical basis and track record to clearly conclude that there is no new technical uncertainties to be identified. It is unlikely that standards and procedures have already been consolidated or are available to address the technology.

Temporary condition: An operational condition that may be a design condition, for example the mating, transit or installation phases.

Tensile strength: Minimum stress level where strain hardening is at maximum or at rupture.

Tidal range: Distance between highest and lowest astronomical tide.

Tidal turbine: may refer to turbine (blades, rotor, nacelle and machinery) only or foundation and support structure or both.

Tide: Regular and predictable movements of the sea generated by astronomical forces.

Transformer Station: Means a module within an electricity generation, transmission and distribution system where voltage is transformed from low to high using transformers servicing either a single HATT or multiple HATTs within an array.

Transit conditions: All unit movements from one geographical location to another.

Turbulence intensity: Ratio between the standard deviation of the current speed and the 10-minute mean current speed.

Ultimate Limit States (ULS): Correspond to the limit of the load-carrying capacity, i.e., to the maximum load-carrying resistance.

Unidirectional: Current and/or waves and/or wind acting in one single direction.

Wake effects: disturbance in the downstream velocity field of a body as a result of hydrodynamic blockage.

Welding procedure: A specified course of action to be followed in making a weld, including reference to materials, welding consumables, preparation, preheating (if necessary), method and control of welding and post-weld heat treatment (if relevant), and necessary equipment to be used.

Witnessing: Means the attendance of tests or measurements where the surveyor verifies compliance with agreed test and / or measurement procedures.

Yaw error: The angle between the current direction (instantaneous direction of attack of the current at hub height) and the rotor axis of HATT, measured in the horizontal plane.

Yawing: Rotation of the rotor axis of a tidal turbine about a vertical axis.

Wave-out: Highest wave height at which a tidal turbine is designed to produce power.

1.8 Acronyms, Abbreviations and Symbols

1.8.1 Acronyms and abbreviations

<i>Short form</i>	<i>In full</i>
ADP	Acoustic Doppler Profiler
ADV	Acoustic Doppler Velocimeter
ALARP	As Low As Reasonably Practicable
ALS	Accidental Limit State
CFD	Computational Fluid Dynamics
CMC	Certification of Materials and Components
CMS	Condition Monitoring System
CPT	Cone Penetration Test
CPT	Cured Ply Thickness
DLC	Design Load Case
DFF	Design fatigue factor
DOF	Degrees of Freedom
FEA	Finite Element Analysis
FLS	Fatigue Limit State
FMEA	Failure Modes and Effects Analysis
FMIRR	Failure Mode Identification and Risk Ranking
FRP	Fibre-reinforced Plastic
FV	Fibre Volume
GACP	Galvanic Anode Cathodic Protection
HAT	Highest Astronomical Tide
HATT	Horizontal Axis Tidal Turbine
HAZID	Hazard Identification
ICCP	Impressed Current Cathodic Protection

<i>Short form</i>	<i>In full</i>
IEC	International Electrotechnical Commission
IFF	Inter-fibre Failure
IPE	Implementation of design-related requirements in Production and Erection
ISO	International Organization of Standardization
LAT	Lowest Astronomical Tide
LDD	Load Duration Distribution
LF	Low Frequency
LRFD	Load and Resistance Factor Design
LVRT	Low-voltage Ride Through
MSA	Manufacturing Surveillance Agreement
MWL	Mean Water Level
NA	Not Applicable
NDT	Non-destructive Testing
OE	Orientation Error
OEM	Original Equipment Manufacturer
OS	Legacy DNV Offshore Standard
PTO	Power Take-Off
QM	Quality Management
ROV	Remotely Operated Vehicle
SCF	Stress Concentration Factor
SLS	Serviceability Limit State
SWL	Still Water Level
TSWL	Total Still Water Level
ULS	Ultimate Limit State
VIV	Vortex Induced Vibrations
WSD	Working Stress Design

1.8.2 Symbols

1.8.2.1 Latin characters

A	accidental load
g, g_0	acceleration of gravity
n	number of samples
n_c	number of applied cycles
t	time
z	height, vertical distance
z_b	vertical distance
C_D	drag coefficient
C_M	mass coefficient
C_P	power coefficient
C_S	slamming coefficient
C_T	thrust coefficient
d	water depth to still water level
D	deformation load
D_c	characteristic cumulative damage
D_D	design cumulative damage
E	modulus of elasticity
E	environmental load
G	permanent load
G	strain energy release rate
h	height
H	wave height
H_c	wave crest height
H_{max}	maximum wave height
H_s	significant wave height
I_{max}	short circuit current
I	turbulence intensity
N	number of sea states
N	number of cycles to failure
n_A	activation rotational speed

n_{max}	maximum overspeed
n_3	maximum operating speed
n_4	cut-out rotational speed
Q	variable functional load
P_A	activation power
P_r	rated power
P_T	over-power
R	resistance
rms	root mean square
S	load effect
S	power spectral density
S_d	design load effect
SZl	lower limit of the splash zone
SZu	upper limit of the splash zone
T	duration
T	wave period
T_d	return period
T_D	design life of structure
T_p	peak period
T_R	reference period
T_S	sea state duration
T_Z	zero-up-crossing period
U_{10}	10-minute mean current speed
U_C	total current speed
$U_{C,sub}$	sub-surface current speed
$U_{C,wind}$	wind induced current speed
$U_{C,surf}$	coastal current speed
U_{in}	cut-in flow speed
U_{out}	cut-out flow speed
U_r	rated flow speed
U_T	total flow speed
U_W	streamwise wave particle velocity
W_{out}	wave out wave height
V_{10}	10-minute mean wind speed

1.8.2.2 Greek characters

$\Delta\sigma$	stress range
γ_f	load factor
γ_m	material factor
ϕ	friction angle
ϕ_A	Cut-out yaw error
η	utilization factor
λ	wavelength
λ	reduced slenderness
λ	tip-speed
θ	angle
μ	friction coefficient
μ	mean value
ν	Poisson's ratio
ρ	density of seawater, density of air
σ	standard deviation
σ_d	design material strength
σ_k	characteristic material strength
ω	angular wave frequency
Ψ	load combination factor, load reduction factor

Ψ	load factor for permanent load and variable functional load
--------	-------------------------------------------------------------

1.8.2.3 Subscripts

C, k	characteristic value
d	design value
p	plastic
ref	reference
u	streamwise
v	lateral
w	vertical
y	yield

1.9 Approach regarding configurations not included in the HATT systems

Generic configuration of HATT covered in this standard is given in [1.3]. Where particular configuration specifications fall outside of these generic boundaries they will be covered outside of the general requirements for certification, with each feature being considered on a case-by-case basis.

The Technology Assessment and Failure Mode Identification and Risk Ranking (FMIRR) used in the generic HATT configuration are provided in APPENDIX A – TECHNOLOGY ASSESSMENT, NOVEL ASPECTS AND FMIRR. They are the basis for the requirements in this standard and should be modified and adapted to the new configurations, resulting in new specific requirements to be followed during the certification process.

1.10 Certification principles and risk based approach

1.10.1 Introduction

For a complete description of the certification principles, reference is made to DNV-OSS-312 Sec. 2.

Certification is a comprehensive service providing assurance that a set of requirements laid down in standards are met during design and construction, and maintained during operation. Certification has gained world-wide recognition as representing an acceptable level of safety and quality.

Certification implies an activity in which a HATT is surveyed by DNV GL during construction on the basis of design approval, tested before being taken into service, and surveyed regularly during its operational life. The aim is to verify that relevant requirements are built-in, observed and maintained.

The certification shall be documented by a set of specific, agreed deliverables and certificates.

In order to maintain the Certificate, the HATT needs to be satisfactorily maintained and modifications adequately addressed. This shall be confirmed by annual and periodic surveys.

The principles and procedures outlined in DNV-OSS-312 and in this document aim at implementing certification complying with the aspects above and in line with marine renewable certification as defined in DNV-OSS-312 Sec. 1 A103.

1.10.2 Risk based approach – overall description

Designs of HATT may typically contain important subsystems for which there is no relevant service history. These systems, loads and load-structural interaction effects may not be adequately addressed by existing codes or standards.

In order to overcome this shortcoming in the Certification process, DNV GL has developed a risk based approach based on the DNV-RP-A203 Qualification of New Technology. The risk based approach is well suited to deal with the uncertainties and limited data as well as to adjust the process to include all main requirements for a successful technology. In this case the technology has to perform reliably to a satisfactory economic cost.

The overall certification process can be outlined as in Figure 1-2.

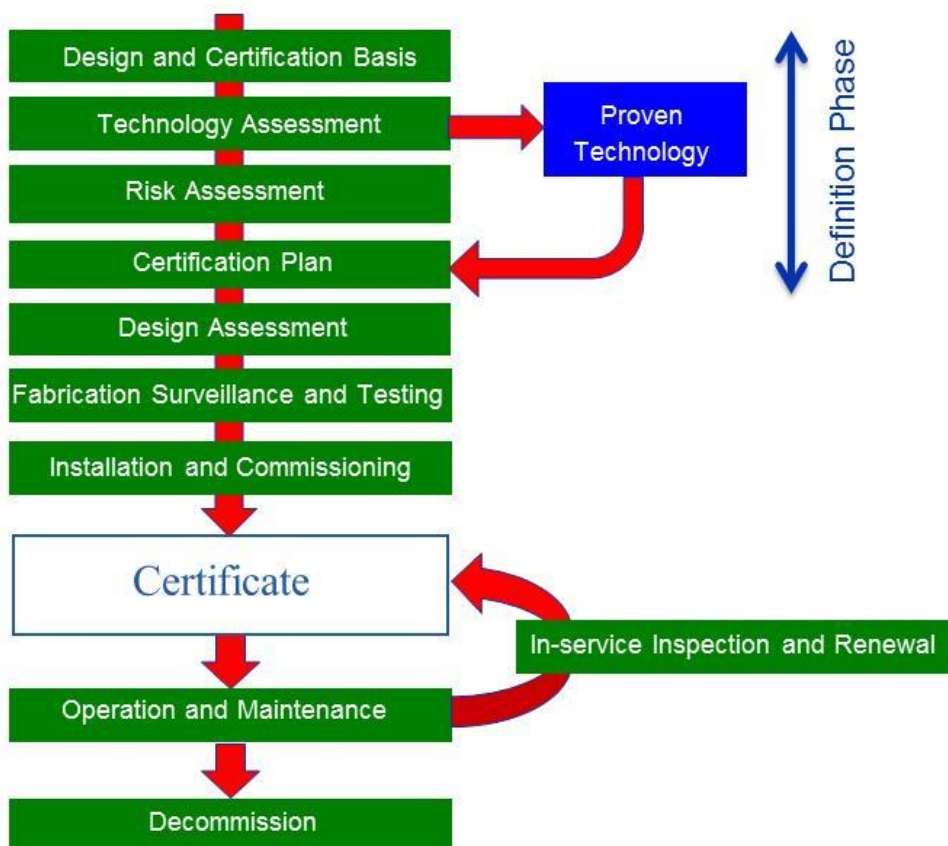

Figure 1-2 Certification Process – DNV-OSS-312

When developing the requirements for the HATT, the Definition Phase was carried out for a generic configuration of HATT as described in [1.30].

In [1.10.3] an overview of the process used during the definition phase for the generic HATT is given. This should also provide guidance for certification of HATT that differs from the configuration considered in this standard.

1.10.3 Definition phase

The Definition Phase comprises the following steps:

- a) Definition of Certification Basis
- b) Performance of Technology Assessment
- c) Performance of Failure Mode Identification and Risk Ranking

d) Definition of Certification Plan.

1.10.3.1 Certification Basis

The Certification Basis consolidates all targets, requirements, assumptions and methodologies essential for the design of HATTs, among others codes and Standards, design parameters, assumptions, methodologies and principles, as well as other requirements such as conditions for manufacturing, transportation, installation, commissioning, operation and maintenance. The Certification Basis specifies the principal input for the design process, in order to ensure that the final product can withstand the loads expected within the design lifetime while performing its duty. It defines the comprehensive range of boundary conditions that impact upon design and operation of a HATT / array of HATTs.

1.10.3.2 Technology Assessment

Technology Assessment is used for identification of the parts of the technology where little or no experience exists, or where proven technology is used in new applications. For the remaining parts of the technology more traditional certification activities may be applied. The evaluation of new versus proven technology is performed according to the procedure illustrated in Table 1-7. This assessment has to be performed at the level of detail necessary to separate proven from new technology. Parts of the sub-systems may be arranged together with known as well as unproven technologies.

The Technology Assessment is performed by dividing the technology into manageable elements in order to assess where the novel aspects lay, and to identify the key challenges and uncertainties.

The Technology Assessment process shall be carried out based on (but not limited to) the following documents.

- Certification basis
- Layouts and general drawings of items subject to assessment
- Drawings and descriptions of control and safety systems
- Material specifications
- Outline fabrication procedures
- Outline installation procedures
- Outline inspection and maintenance procedures

The novel aspects and applicable standards against which the different parts of HATT technology are assessed have been identified to allow a better understanding of the system (and its use), and to put emphasis on the areas upon which a detailed description of failure modes and mechanisms is expected in the subsequent process (FMIRR).

The following steps are taken:

- a) Division of the technology into manageable elements
- b) Assessment of each element's life cycle into phases such as (but not limited to)
 - operation and maintenance
 - fabrication and testing
 - transportation and storage

- installation
 - activation and commissioning
 - decommissioning
 - retrieval and abandonment
- c) Assessment of the technology elements with respect to novelty based on the Technology Assessment matrix
- d) Identification of the main challenges and uncertainties related to the new technology aspects. For complex systems it is recommended that the main challenges and uncertainties are identified by carrying out a high level HAZID.

Application area may refer to the experience of the operating condition, or the environment, or the purpose for which the technology shall be used. A change to the normal operating environment or a different application / use of the technology will lead to increased uncertainty - the most uncertain case being where no experience exists within industry for a particular application of the technology in question. In such cases the category of "New" is inserted against "Application Area". The least uncertain case is where there is appropriate documented knowledge for the use of the technology element under similar conditions and applications, in which case the category would be "Known".

Technology Status refers to the technology itself. A change in any of the elements of existing technology (parts, functions, processes, subsystems) will lead to increased uncertainty resulting in selecting the Technology Status "Limited Field History" or "New or Unproven". The change may be related to hardware or software components of the technology. Change may be related to technology elements such as new architecture configuration, system interfaces, and increased reliability requirements. The increased uncertainty may change the overall performance of the technology and its acceptance criteria.

Technology Classification does not consider the consequence of failure. As an example, Class 4 may be assigned to a technology element whereas its failure may have little effect on overall system performance. If considered of value, the combination of Technology Classification and consequence of failure – possibly in combination with other relevant factors for the technology – may be used to determine the technology criticality. Such criticality may be used to prioritise qualification activities.

Each component falling in Class 1 or 2 shall be attributed one or several applicable standards, each of which shall be referenced.

For each component falling in Class 2 and above, the inconsistencies between the attributed Standards' assumptions and the component's application area shall be referenced in the "New aspects" column. (See APPENDIX A – TECHNOLOGY ASSESSMENT, NOVEL ASPECTS AND FMIRR).

Table 1-7 – Technology Classification

<i>Application Area</i>	<i>Technology Status</i>		
	<i>Proven</i>	<i>Limited field history</i>	<i>New or unproven</i>
Known	1	2	3
New	2	3	4
Notes: 1: No new technical challenges 2: New technical uncertainties 3: New technical challenges 4: Demanding new challenges			

1.10.3.3 Failure Mode Identification and Risk Ranking

The FMIRR is based on the Failure Mode and Effects Analysis (FMEA) that is a qualitative reliability technique for systematically analysing each possible failure mode within a hardware system, and identifying the resulting effect on safety, environment, operation and asset. The Risk Ranking is a quantitative procedure which ranks failure modes according to their probability and consequences (i.e. the resulting effect of the failure mode on safety, environment, operation and asset).

The FMIRR process shall be carried out based on (but not limited to) the following documents:

- Certification Basis
- Technology Assessment
- Detailed drawings of items subject to review
- Drawings and descriptions of control and safety systems
- Material specifications
- Outline fabrication procedures
- Outline installation procedures
- Outline inspection and maintenance procedures

This work shall bring a further understanding of the considered system, and increase emphasis on the areas upon which a detailed description of failure modes and mechanisms is expected in the subsequent process (Failure Mode Identification and Risk Ranking – see APPENDIX A – TECHNOLOGY ASSESSMENT, NOVEL ASPECTS AND FMIRR). The consequence and probability classes as well as the risk matrix are described in [1.10.3.4].

The information from the Technology Assessment together with the breakdown of technology (and technology class) as well as any novel aspects is used as the starting point for the FMIRR.

The failure modes are identified to the level required by the technology class and by addressing the novel aspects identified. The failure mechanisms are listed with focus on the aspects affected by the novel aspects and uncertainties.

Possible early detection of failures should be identified where possible, as the capacity to detect early failures with high probability (and an unequivocal relationship between signal and failure) will influence the definition of the consequences of failure. Detection may in some cases be related to the early stages of failure, or may be related to the development of a mechanism that will lead to subsequent failure.

For the description of consequence, the worst consequence is considered and listed. Consequences should consider any impact on the safety, environment, operation and asset aspects.

Before defining the consequence class for the failure mode, the current controls embedded into the design philosophy and implied in the standards adopted (i.e. redundancy, increased safety level, higher margins, additional proof tests, enhanced fabrication methods and increase levels of NDE), are identified and its impact on the consequence class considered.

The probability of the event is addressed based upon the existing reliability database or upon implied probabilities of failure from the standards adopted. The impact of the novelty is to be



taken into account, and the uncertainty is to be added to any relevant information from other industries or any limited experience from the technology developer.

Assumptions and other aspects considered in the process need to be included and considered during the next stages, including design, fabrication, commissioning and in-service life.

For risks identified as “medium” or “high”, recommendations are to be derived in order to reduce the consequence or the probability (or both) in demonstrating that the overall level of the risk has been lessened.

Recommended actions should be assigned to an individual who is responsible for the execution and reporting of that action. They should also hold responsibility for the updating of the FMIRR in recording the impact of that action. After evaluation of the results, re-ranking of the risk can be performed. Where a risk remains high, further action is required to be defined and the FMIRR cycle repeated with the updated information.

Data from the in-service life is to be used as a way to re-evaluate the FMIRR and its conclusions.

The following should be observed during the implementation of the process:

- a) The methodology considers one failure at time. However, when one failure can be connected to another failure (i.e. the overall probability is not affected by the two events), the two failures should be considered in the ultimate consequence assessment. Time delay between events may be considered, and may reduce the consequence by stopping operation before the second failure occurs.
- b) Where probability of failure is uncertain, emphasis should be given to consequences when recommending actions (e.g. one of the actions in this case could be to obtain more data to reduce uncertainty in the probability of failures before committing to serial production).
- c) Different failure modes shall be addressed in different rows (as they may have different failure mechanisms).
- d) Different failure mechanisms shall be addressed in different rows (as they may have a different risk ranking).
- e) Level of detail of failure modes and failure mechanisms shall be increased for technologies where technology class is equal to or higher than 3.
- f) It is assumed that quality control and quality assurance is applied during the design and manufacturing / commissioning as well as the normal design actions. Thus, control measures to be listed are measures with direct effect on the consequence and / or probability of failure.

1.10.3.4 Risk Matrix

The requirements in this standard were preliminarily derived based on the present understanding of the uncertainty and risks of a generic HATT and using the systematic approach of identification of technology novelty and failure modes identification and risk ranking.

During this process, the following probability and consequence classes were defined as in Table 1-8 and Table 1-9.

Table 1-8 Probability Classes

<i>Class</i>	<i>Name</i>	<i>Description</i>	<i>Indicative Annual Failure Rate (up to)</i>	<i>Reference</i>
1	Very Low	Negligible event frequency	1.0E-04	Accidental (event not failure)
2	Low	Event unlikely to occur	1.0E-03	Strength / ULS
3	Medium	Event rarely expected to occur	1.0E-02	Fatigue / FLS
4	High	One or several events expected to occur during the lifetime	1.0E-01	Operation low frequency
5	Very high	One or several events expected to occur each year	1.0E+00	Operation high frequency

Table 1-9 Consequence Classes

<i>Class</i>	<i>Description of consequences (impact on)</i>				
	<i>Safety</i>	<i>Environment</i>	<i>Operation</i>	<i>Assets</i>	<i>Cost (GBP)</i>
1	Negligible injury, effect on health	Negligible pollution or no effect on environment	Negligible effect on production (hours)	Negligible	1k
2	Minor injuries, health effects	Minor pollution / slight effect on environment (minimum disruption on marine life)	Partial loss of performance (retrieval not required outside maintenance interval)	Repairable within maintenance interval	10k
3	Moderate injuries and/or health effects	Limited levels of pollution, manageable / moderate effect on environment	Loss of performance requiring retrieval outside maintenance interval	Repairable outside maintenance interval	100k
4	Significant injuries	Moderate pollution, with some clean-up costs / Serious effect on environment	Total loss of production up to 1 m (GBP)	Significant but repairable outside maintenance interval	1m
5	A fatality	Major pollution event, with significant clean-up costs / disastrous effects on the environment	Total loss of production greater than 1 m (GBP)	Loss of device, major repair needed by removal of device and exchange of major components	10m

The risk matrix, considering the normal safety factor, is defined in Table 1-10.

Table 1-10 Risk Categories

<i>Probability</i>	<i>Consequence</i>				
	<i>1</i>	<i>2</i>	<i>3</i>	<i>4</i>	<i>5</i>
5	Low	Med	High	High	High
4	Low	Med	Med	High	High
3	Low	Low	Med	Med	High
2	Low	Low	Low	Med	Med
1	Low	Low	Low	Low	Med

Notes:
 Low Tolerable, no action required
 Medium Mitigation and improvement required to reduce risk to Low
 High Not acceptable: mitigation and improvement required to reduce risk to Low (ALARP)

1.10.3.5 Certification Plan

The Certification Plan, defined from the results of the Risk and Technology Assessments and subsequent results from the FMIRR, resulted in the requirements described in this standard. The main new aspects for the HATT are presented in detail in APPENDIX A – TECHNOLOGY ASSESSMENT, NOVEL ASPECTS AND FMIRR and should be continuously considered as new information and theoretical models are developed. These new aspects and the identified risks from the FMIRR were used to derive the requirements in this standard.

Different HATT configurations than covered in this standard shall use the process described above and check if the certification requirements need modification considering the new targets, novelty and risks.

2 DESIGN PRINCIPLES

2.1 Introduction

2.1.1 Safety philosophy

Whilst defining the safety philosophy to be applied to the HATT, it is important to consider that safety to personnel is not necessarily the only consideration, with expectations from the different stakeholders and the balance between survivability, reputation, maintenance, repairs and production costs also being key aspects for consideration. An overall safety philosophy should be clearly established covering all phases up to and including decommissioning.

A Safety Philosophy for the HATT certification standard is proposed considering the following aspects and stakeholders:

- Risk to life (during installation and removal, access to device during in-service life, risk to navigation and others during in-service life).
- Environmental impact due to any fluid releases, anti-fouling coatings, bilge water, and location of site relative to sensitive environments (protected species or sensitive sites and visual impacts).
- Inspection and maintenance cost, risks during removal of equipment for inspection and maintenance.
- Safety level expected by the Authorities. This may include Authority requirements in other countries which are potential marketing targets for the device(s).

Additional aspects that will also define the philosophy to be used are:

- Balance between reliability, survivability and maintainability.
- Loss of production.
- Experience of developer, industry, concept (survivability of the device to extreme environment is very important in terms of impact on industry).
- Underwriter perception of risks and definition of premium value (during installation and removal, and in-service life).
- Financial or venture capital communities' perception of risk to the return on investment.

2.1.2 Safety classes and target safety level

Three safety levels have been identified in the draft of IEC/TS 62600-2, Part 2: "Design requirements for marine energy systems" (currently under preparation), as defined below:

Table 2-1 Safety levels

<i>Safety Level</i>	<i>Definition</i>	<i>Probability of failure</i>
High	Operating conditions where failure implies: high risk of human injury, significant environmental pollution or very high economic or political consequences.	$< 10^{-5}$ per annum (p.a.)
Normal	For temporary or operating conditions where failure implies: risk of human injury, significant environmental pollution or high economic or political consequences. This level normally aims for a risk of less than 10^{-4} per year of a major single accident. It corresponds to a major incident happening on average less than once every 10,000 installation years. This level equates to the experience level from major representative industries and activities.	$<10^{-4}$ p.a.
Low	Failure implies low risk of human injury and minor environmental and economic consequences.	$<10^{-3}$ p.a.

Safety classes may be considered while defining redundancy or safety features for the equipment and systems. Higher levels of safety may be required for critical sub-systems and components depending on their consequences of failure.

As an example, due to access difficulties for unplanned maintenance (plus costs related to offshore intervention, and any additional “downtime” penalties when not generating to the grid), a higher level of reliability may be required.

Hence, safety aspect impacts all service and operational requirements resulting from the use of the device and the environmental conditions that can affect the design.

The target safety level for structural design of foundations, sub-structure, nacelle, blades and hub to the normal safety class according to this standard is a nominal annual probability of failure of 10^{-4} . This target safety is the level aimed at for structures, whose failures are ductile, and which have some reserve capacity.

The target safety levels for the different systems and components were identified in the risk assessment stage taking into account the present constraints regarding access and aimed reliability. The normal safety level is aimed and it is reflected in the use of existing standards from other industries and adjusted requirements to address novelty and risks as given in the sections covering the pitch and yaw systems, drivetrain, seals, bearings, auxiliary, electrical and control systems.

2.2 Structural design

2.2.1 Objectives

This section describes design principles and design methods for structural design, including:

- design by partial safety factor method with linear combination of loads or load effects;
- design by partial safety factor method with direct simulation of combined load effect of simultaneous load processes;
- design assisted by testing; and
- probability-based design.

General design considerations regardless of design method are also given in [2.2.3].



This standard is based on the partial safety factor method, which is based on separate assessment of the load effect on the structure due to each applied load process. The standard allows for design by direct simulation of the combined load effect of simultaneously applied load processes, which is useful in cases where it is not feasible to carry out separate assessments of the different individual process-specific load effects.

As an alternative or as a supplement to analytical methods, determination of load effects or resistance may in some cases be based either on testing or on observation of structural performance of models or full-scale devices.

Structural reliability analysis methods for direct probability-based design are mainly considered as applicable to special case design problems, to calibrate the load and material factors to be used in the partial safety factor method, and to design for conditions where limited experience exists.

2.2.2 Aim of the design

Structures and structural elements shall be designed to:

- sustain loads liable to occur during all temporary, operating and damaged conditions if required;
- ensure acceptable safety of structure during the design life of the structure;
- maintain acceptable safety for personnel and environment;
- have adequate durability against deterioration during the design life of the structure.

The specific targets for the aim of the design listed above were derived based on the steps in the Definition Phase described in [1.10.3].

2.2.3 Design conditions

The design of a structural system, its components and details shall satisfy the following requirements:

- resistance against relevant mechanical, physical and chemical deterioration is achieved;
- fabrication, testing, transport, deployment, operation, maintenance and retrieval comply with relevant, recognized techniques and practice with due consideration of novel aspects and risk associated with the relevant parts of the structure. Due consideration will need to be given to failure modes and their mechanisms that could lead to accidental and abnormal / emergency conditions as well as requirements from authorities;
- impact of limitation of inspection, maintenance and repair are to be included in the design;
- the basic load cases should consider adjustment due to the uncertainties associated with limited site specific historical metocean data, approximations inherent in simulations and up scaling from tank tests as well as phenomena such as turbulence and wave-current interaction.

Structures and structural components shall possess ductile behaviour unless the specified purpose requires otherwise.

Structural connections are, in general, to be designed with the aim to minimize stress concentrations and reduce complex stress flow patterns.

2.3 Limit states - structures

A limit state is a condition beyond which a structure or structural component will no longer satisfy the design requirements.

The following limit states are considered in this standard:

- Ultimate limit states (ULS): corresponding to the maximum load-carrying resistance
- Fatigue limit states (FLS): corresponding to failure due to the effect of cyclic loading
- Accidental limit states (ALS): corresponding to survival conditions in a damaged condition or in the presence of nonlinear environmental conditions
- Serviceability limit states (SLS): corresponding to tolerance criteria applicable to intended use.

Examples of limit states within each category:

Ultimate limit states (ULS)

- loss of structural resistance (excessive yielding and buckling)
- failure of components due to brittle fracture
- loss of static equilibrium of the structure, or of a part of the structure, considered as a rigid body, e.g. overturning or capsizing
- failure of critical components of the structure caused by exceeding the ultimate resistance (which in some cases is reduced due to repetitive loading) or the ultimate deformation of the components
- excessive deformations caused by ultimate loads
- transformation of the structure into a mechanism (collapse or excessive deformation).

Fatigue limit states (FLS)

- cumulative damage due to repeated loads.

Accidental limit states (ALS)

- structural damage or failure caused by accidental loads
- exceedance of ultimate resistance of damaged structure
- maintain structural integrity after local damage or flooding.

Serviceability limit states (SLS)

- deflections that may alter the effect of the acting forces
- deformations that may change the distribution of loads between supported rigid objects and the supporting structure
- excessive vibrations producing excessive noise or affecting non-structural components
- motions that exceed the limitation of equipment
- temperature-induced deformations.

Accidental limit states with a probability of occurrence of less than 10^{-3} per year and involving only a single turbine unit may be considered as an SLS depending on the level of risk. In the



case that the risk is not acceptable due to safety, environmental, economic or reputational viewpoint, the structural integrity should be improved. Accidental limit states involving progressive failure or failure with high economical or societal impact shall always be considered. The requirements in this standard are based on the process described in Section 16 and consideration of HATT configuration as described in [1.3].

2.4 Design by the partial safety factor method - structures

2.4.1 General

The partial safety factor method is a design method by which the target safety level is obtained as closely as possible by applying load and resistance factors to characteristic values of the governing variables and subsequently fulfilling a specified design criterion expressed in terms of these factors and these characteristic values. The governing variables consist of:

- loads acting on the structure or load effects in the structure
- resistance of the structure or strength of the materials in the structure.

The characteristic values of loads and resistance, or of load effects and material strengths, are chosen as specific quantiles in their respective probability distributions. The requirements for the load and resistance factors are set such that possible unfavourable realizations of loads and resistance, as well as their possible simultaneous occurrences, are accounted for to an extent which ensures that a satisfactory safety level is achieved.

This standard uses the partial safety factor method described in DNV-OS-J101 Sec. 2.

2.4.2 Load and resistance factors

Load and resistance factors for the various limit states are given in Section 6.

2.5 Design by direct simulation of combined load effect of simultaneous load processes – structures

2.5.1 General

Design by direct simulation of the combined load effect of simultaneously acting load processes is similar to design by the partial safety factor method, except that it is based on a direct simulation of the characteristic combined load effect from the simultaneously applied load processes instead of being based on a linear combination of individual characteristic load effects determined separately for each of the applied load processes.

For design of tidal turbines which are subjected to two or more simultaneously acting load processes, design by direct simulation of the combined load effect may prove an attractive alternative to design by the linear load combination model of the partial safety factor method. The linear combination model of the partial safety factor method may be inadequate in cases where the load effect associated with one of the applied load processes depends on structural properties which are sensitive to the characteristics of one or more of the other load processes.

This standard uses the design by direct simulation of combined load effect of simultaneous load processes method described in DNV-OS-J101 Sec. 2.

2.6 Design assisted by testing - structures

2.6.1 General

Design by testing or observation of performance is in general to be supported by analytical design methods.

Load effects, structural resistance and resistance against material degradation may be established by means of testing or observation of the actual performance of full-scale structures.

To the extent that testing is used for design, the testing shall be verifiable.

Full-scale testing and observation of performance of existing structures

Full-scale tests or monitoring of existing structures may be used to give information on response and load effects to be utilised in calibration and updating of the safety level of the structure.

2.7 Probability-based design- structures

For requirements for probability-based design, reference is made to DNV-OS-J101 Sec. 2.

2.8 Systems design

2.8.1 General

The use of offshore standards is acceptable. However, a substantial part of their requirements have been written with high emphasis on safety for manned offshore installations and therefore items which are directly related to the safety of operating staff may be modified for the HATT which is unmanned. Due account needs to be taken of manned periods for installation, dry commissioning, testing, maintenance or removal periods. Correct functioning of the device as a power generating unit is likely to rely on several of safety requirements to be considered.

During the design phase, consideration should be given to the required design life, criticality of the system / component (production or safety), the level of reliability / performance required from the system / components, the maintenance needed to keep the reliability / performance and the associated level of protection necessary to achieve controlled degradation. This should be reflected when defining equipment specification for suppliers and contractors.

It is important to define the internal environment that the systems will be exposed to. These comprise:

- accelerations and inclinations from device movements
- temperature and humidity
- salinity
- vibration levels
- slamming/shock loads
- presence of (salt) water
- electromagnetic interference
- ionising effects (e.g. upon short circuits/tripping of circuit breakers)
- presence of explosive atmosphere (e.g. from trickle charging of batteries).

3 MANUALS FOR ONSHORE AND OFFSHORE WORKS

3.1 General requirements

The following documentation shall be developed:

- Sea Transport and Offshore Installation Manual
- Commissioning Manual
- Operating Manual
- Maintenance Manual
- Periodical Inspections Manual

Target of the verification of these manuals is assurance that the turbine can be transported, installed, operated and maintained according to requirements identified in the design documentation, in particular in respect of

- sequence, timing, limit values,
- arrangements, tools, equipment to be applied,
- limiting environmental conditions,
- protection measures (e.g. caps, vortex ropes, noise protection, active corrosion protection, etc.).

The format and level of detail of the documentation shall be such that qualified personnel with technical training are able to understand the instructions. The documentation shall be expressed in a language which the qualified personnel at the installation site of the tidal turbine are able to understand. IEC 82079: 2012 and IEC 82079-1:2013 shall be observed for the preparation of the operating instructions in addition to this standard.

Type identification of the tidal turbine shall be made in every manual for onshore and offshore works by definition of:

- manufacturer, supplier, importer
- designation, type and, if applicable, type variant
- type of rotor / rotor blade
- rotor dimensions: diameter, height from seabed
- hub height(s) from seabed, water depth
- rated power.

Warnings and measures against hazardous situations shall be provided and cover hazardous situations which may arise through deviation from the planned working sequence. Also, relevant results from the risk assessment have to be included. Countermeasures shall be specified. Such hazardous situations may include: lightning, snow, icing, visibility, extreme temperatures, very high winds, waves or currents during installation, prolonged periods of the support structure standing without topsides structure at critical current speeds and / or wave frequencies. Hazardous situations which may arise due to unintended motion or rotation shall be named, and countermeasures shall be specified to avoid this.



Safety and accident-prevention measures e.g. use of personal protective equipment, guards or locking devices, shall be specified. For personnel entering any enclosed working space, such as the hub or blade interior, safety provisions shall be stated, e.g. standby personnel. Emergency procedures and rescue operations shall be described.

3.2 Sea transport and offshore installation manual

3.2.1 Objective and format

The manual for sea transport and offshore installation shall describe all working steps that have to be performed at sea during transport to the installation location, positioning, assembly and erection of the tidal turbine. The manual applies for one type of tidal turbine and, if applicable, for its variants.

The objective of the manual for sea transport and offshore installation is to provide information for the on sea and offshore activities and procedures to all parties involved, including the turbine designer and certification body.

For the issuance of the Project Certificate, the sea transport and offshore installation manual shall be expressed in a language which the qualified technical personnel at the installation site of the tidal turbine are able to understand, plus a version in English.

Notes regarding safety and regulations for the prevention of accidents shall be so arranged in the text that they appear before the operating action in question. They shall be highlighted clearly as being safety and accident-prevention notes.

3.2.2 Scope and content

The sea transport and offshore installation manual may contain documents and information which vary from site to site (e.g. water depth, vessels, buoys, lights). The variable information shall be given with upper and lower limiting values and documents (e.g. arrangement of vessels) shall be given as example for the Type Certification process. Finalized documents with site-specific information shall be issued in the Project Certification.

The manual shall contain the following information at least.

- Identification of installation site
- Prerequisites for sea transport and offshore installation
- Sequence of sea transport and offshore installation
- Form sheet for the record of sea transport and offshore installation

3.2.2.1 Identification of installation site

Position of the offshore site shall be defined.

3.2.2.2 Prerequisites for sea transport and offshore installation

Prerequisites for sea transport and offshore installation shall be stated, e.g. requirements for the weather conditions (limiting wind speeds, temperatures, rainfall, precipitation, wave height, water level and current speed), requirements for site access and working area or adequate curing of the foundation or any grouted connections.

The precise designations and dimensions of all plant components to be assembled and erected shall be specified, together with all data needed for erection, such as weights, lifting points etc.



Special tools or equipment necessary for the installation shall be specified with due consideration for the loads and weights during installation. Requirements for these tools or equipment, e.g. testing or regular inspections, shall be specified.

The maximum admissible delay between installation and erection of the support structure and the maximum admissible delay until mounting of the topsides structure shall be stated.

Requirements for the vessels (tug power, navigation equipment etc.) and other equipment used (floating cranes etc.) shall be stated.

A listing including quantities of all equipment and material necessary for the installation shall be given, e.g. grouting material, bolts, mooring and fastening equipment, special tools.

The required qualifications for the technical personnel shall be defined in the manual for sea transport and offshore installation. The intended route and duration of sea transport shall be stated.

3.2.2.3 Sequence of sea transport and offshore installation

Sequence of sea transport and offshore installation shall be duly described including all working steps needed for installation. Auxiliary equipment and resources shall be specified exactly (e.g. lubricants, grouting materials, oil for filling up the gearbox). References to drawings, specifications or instructions necessary for the sea transport and offshore installation shall be made.

Arrangement of vessels, buoys, lights etc. shall be described, including the mooring / positioning equipment. Lifting, lowering, touchdown and ballasting procedures shall be described where relevant, including admissible draft(s) and / or bottom clearance(s).

The work instructions for the execution of the bolted connections needed during installation shall be included.

All necessary tests and checks shall be listed. Procedures for energizing electrical equipment shall be provided. Necessary monitoring of seabed conditions, scouring etc. shall be described where relevant.

A description shall be made of the measures to be taken, if the turbine is out of operation for a longer period e.g. because of absence of the grid connection. Actions and measures in the case if operation is started after such period shall be stated.

3.2.2.4 Form sheet for the record of sea transport and offshore installation

The form sheet for the record of sea transport and offshore installation shall be prepared to document the execution of the individual working steps during the sea transport and offshore installation process. A blank form sheet of the sea transport and offshore installation report shall be added to the sea transport and offshore installation manual. For each check and working step, there shall be appropriate fields to be filled in, together with fields for recording measurement values and test results. All adjustment settings and set values as well as the expected measurement results shall be specified.

The sea transport and offshore installation record may consist of several sub-records (e.g. for different assemblies or phases of work). The following fields shall be provided as a minimum:

- type identification of the tidal turbine
- serial number, operator and installation site of the tidal turbine

- name of the person carrying out the corresponding working step
- weather conditions, if the weather is able to influence the quality of work (e.g. temperature, rain, hail, range of sight, lighting, average wind speed, gust wind speed, wave height and tidal condition)
- reports of the execution of all working steps
- reports of the execution of all tests and checks
- extra space for possible remarks or items outstanding
- date and signature of the person(s) responsible.

3.3 Commissioning manual

3.3.1 Objective and format

The commissioning manual shall describe all working steps that have to be performed during commissioning in order to ensure safe functioning of the tidal turbine. The commissioning manual applies for one type of tidal turbine and, if applicable, for its variants.

For the issuance of the Project Certificate, the commissioning manual shall be expressed in a language which the qualified technical personnel at the installation site of the tidal turbine are able to understand.

3.3.2 Scope and content

In addition to general requirements to onshore and offshore manuals, the commissioning manual shall contain the following information as a minimum.

- Checks required before commissioning
- Working steps for commissioning
- Form sheet for the commissioning report

3.3.2.1 Checks required before commissioning

Checks required before commissioning shall be listed. The following checks shall be documented:

- completion of installation and assembly to full extent
- completion of commissioning of the auxiliary systems and subsequent external equipment needed for operation of the tidal turbine (e.g. transformer, grid connection station)
- completion of trial runs of individual components which may be necessary in the factory or on site
- filling up of all operating media (e.g. lubricants, coolants, hydraulic fluid, nitrogen in pressure tanks)
- completion of acceptance tests needed according to governmental regulations (e.g. for pressure vessels, lifts)

The required qualifications for the technical commissioning personnel shall be defined in the commissioning manual.

3.3.2.2 Working steps for commissioning

Working steps for commissioning shall be described. For the commissioning of individual assemblies (e.g. yaw system), reference may be made to subordinate commissioning manuals for such assemblies. All prerequisites for the proper execution of commissioning, e.g. lowest / highest tidal speed, wave heights and necessary outside temperatures, shall be specified.

Tests of all functions of the safety systems and the braking systems shall be described. The switching values to be set and the criteria to be met shall be specified. The following tests shall be performed as a minimum:

- function of all emergency stop pushbuttons
- function of all sensors and switches which also act on the safety system (e.g. overspeed test)
- measurement of the essential parameters of the braking systems, e.g. speed of blade pitching, hydraulic pressure of the mechanical brake(s)
- response of all necessary plant functions after activation of the safety system (e.g. braking systems, generator disconnection)
- test to verify that the functions responding to the activation of the safety system are independent of the control system
- grid loss
- testing of all limiting values and parameters that have been set for the safety system.

All tests regarding the functions of the control system of the tidal turbine shall be described.

The switching values to be set and criteria to be met shall be specified. The following tests shall be performed as a minimum:

- automatic start-up
- shut-down with all braking procedures
- plausibility check of the yaw system
- plausibility check of the measurement values
- comparison of the limiting values and parameters which were set with the prescribed values as documented.

Furthermore, the following working steps shall be described:

- registration of the data on the rating plates of the primary components
- possible settings to be made in the control system on the basis of the measurement results (e.g. natural frequency of the support structure)
- familiarisation of the tidal turbine operating personnel.

Checks to conclude commissioning shall be listed. The following statements shall be provided as a minimum:

- visual inspections (e.g. rotor blades, corrosion protection, tightness of hydraulic system)
- checking of the required notices and warning plates.

- description of tidal turbine operation during the running-in-period upon the commissioning shall be provided.

3.3.2.3 Form sheet for the commissioning report

Form sheet for the commissioning report shall be prepared to document the execution of all checks and working steps of the commissioning process. For each check and working step, there shall be appropriate fields to be filled in, together with fields for recording the measurement values and test results. All adjustment settings and set values as well as the expected measurement results shall be specified. The commissioning report may consist of several sub-reports (e.g. for primary components, for familiarization of the operating personnel). The following fields shall be provided as a minimum:

- type identification of the tidal turbine
- serial number, operator and installation site of the tidal turbine
- manufacturer, type and serial number from the rating plates of the primary components, at least of the rotor / rotor blades, gearbox, generator and support structure
- persons present during commissioning
- weather conditions on the day of commissioning
- confirmation that all checks required before the start of commissioning have been completed
- report on the execution of all working steps of the commissioning
- confirmation that all checks required to conclude commissioning have been completed
- extra space for possible remarks, items outstanding or parts replaced
- date and signature of the person(s) responsible

3.4 Operating manual

3.4.1 Objective and format

The operating manual shall provide the operator or his representative with the knowledge necessary for proper operation of the tidal turbine. The operating manual applies for one type of tidal turbine and, if applicable, for its variants.

3.4.2 Scope and content

In addition to general requirements to onshore and offshore manuals, the operating manual shall contain the following information.

- Notes for users
- Help with fault-finding
- Operating records

3.4.2.1 Notes for users

Notes for users shall provide at least the following information:

- general description of the operation concept
- description of the functions and operational modes of all the operating and indicating elements (switches, pushbuttons, lamps, measuring instruments)

- description of starting and stopping procedures
- description of emergency shut-down
- explanation of fault messages (insofar as these are issued)
- description of all work procedures required for the operating of the tidal turbine (e.g. necessary communication)
- emergency procedure plans, e.g. action required in the event of overspeeding, lightning storms, earthquakes, brake failure, rotor imbalance, loose fasteners or fire at the tidal turbine
- description of the functions and operating modes of all the operating and indicating elements (switches, pushbuttons, lamps, measuring instruments)
- explanation of malfunctions and how to clear them
- description of components and functions that need to be taken into / out of service on a seasonal basis or for other reasons
- description of measures to be taken if the tidal turbine is taken out of operation for a longer period, e.g. because of damage to the grid connection. These measures could be e.g. lockage of the blade pitch system and / or rotor, or installing a backup power supply.
- description of the measures to be taken, if the turbine is out of operation for a longer period e.g. because of absence of the grid connection; actions and measures in the case if operation is started after such period shall be stated.
- description of measures to be taken if the tidal turbine is taken into operation after a longer period of standstill. The measures could be e.g. opening of locks and / or drying / heating of components that need to be dry when re-powered.

Emergency procedures for life saving, e.g. in case of ship collision or fishery interaction as well as procedures for safe evacuation of personnel shall be described.

3.4.2.2 Help with fault-finding

Help with fault-finding shall be available. Without carrying out any repairs himself, the operator should be capable of recognizing the cause of a malfunction and – insofar as it cannot be cleared simply by an operating action – of providing the qualified technical maintenance personnel with useful advance information. The operator should be able to judge whether a fault constitutes or can develop into a hazardous situation.

3.4.2.3 Operating records

Operating records shall be kept and shall include the following:

- type identification of the tidal turbine
- serial number, operator and installation site of the tidal turbine
- operating hours
- shut-down hours
- date and time of fault
- nature of fault

- date and time of maintenance or repair activity
- nature of maintenance or repair activity.

3.5 Maintenance manual

3.5.1 Objective and format

The maintenance manual shall describe execution of all individual working steps that have to be performed during maintenance in order to ensure safe functioning of the tidal turbine; this includes supervising actions, reconditioning, repairing, adjusting and cleaning. The maintenance manual applies for one type of tidal turbine and, if applicable, for its variants.

3.5.2 Scope and content

In addition to general requirements to onshore and offshore manuals, the maintenance manual shall contain the following information at least:

- Prerequisites for the execution of the maintenance work
- Working steps of the maintenance
- Form sheet for the maintenance report
- Maintenance plan

3.5.2.1 Prerequisites for the execution of the maintenance work

All prerequisites for the execution of the maintenance work shall be stated, e.g. requirements for the weather conditions (wind, current, waves, temperatures).

Special tools or lifting devices necessary for the maintenance shall be specified. All tools, spare parts and auxiliary materials that have to be stored permanently in the tidal turbine shall be listed. The intervals for regular checks for completeness of these parts shall be specified.

Technical documentation of the tidal turbine and their subsystems including e.g. wiring diagrams, hydraulic schemes or lubrication charts shall be available.

The required qualifications for the technical maintenance personnel shall be defined in the maintenance manual.

3.5.2.2 Working steps of the maintenance

Working steps needed for maintenance or inspections shall be described. The descriptions may be supplemented by appropriate pictorial representations.

The objectives of the individual maintenance operations (oil levels, brake settings, oil pressures etc.) shall be indicated clearly. The frequency of the schedule maintenance (e.g. half-yearly, yearly or five-yearly) shall be specified.

A set of work instructions for the inspection of bolted connections shall be added to the maintenance manual.

A detailed listing and description of the necessary tests for the safety system (e.g. overspeed test, emergency shut-down functions, measurement of the nitrogen content in hydraulic accumulators) shall be included in the maintenance record. The required frequency of these tests shall be indicated (e.g. annually). The completion of the tests shall be recorded in the maintenance report.



A detailed listing and description of the necessary inspection and tests of the lightning protection system shall be included in the maintenance manual. The required frequency of these inspections and tests shall be indicated (e.g. annually).

If applicable, the investigations of technical experts and authorized persons, as required by the relevant national regulations (e.g. for lifts, fire-extinguishing systems and pressure vessels) and conditions of the building permits, shall be included in the maintenance manual, and columns / sections shall be provided in the maintenance report for the confirmation that these investigations have been carried out.

All components and auxiliary materials of the tidal turbine that have to be exchanged according to schedule during the operating life (e.g. hydraulic hoses, brake pads, slip rings, gear oil) shall be listed. The intervals or criteria for the exchange shall be specified.

A description of all inspections and tasks to be carried out at the outside lighting equipment as well as rescue at sea equipment and possible backup power supply units shall be included in the maintenance manual if applicable.

A detailed listing and description of the necessary inspections to be done at the scour protection system at the foundation shall be included in the maintenance manual. Actions and corrective measures to be taken in case of damages or inadmissible wear shall be stated.

A description of all inspections and tasks to be carried out at the corrosion protection system (both coating and cathodic protection systems, as applicable) shall be included in the maintenance manual.

A description of the measures to be taken, if the turbine is out of operation for a longer period e.g. because of absence of the grid connection. Actions and measures in the case if operation is started after such period shall be stated.

An instruction to at least yearly take samples of the oil from the main gearbox and analyse these samples (including measurement of the cleanliness) shall be included in the maintenance manual. In addition, information shall be given about the quality and quantity of spare parts and auxiliary materials to be used, e.g. lubricants (spare parts list).

Emergency procedures for life saving, e.g. in case of ship collision or fishery interaction as well as procedures for safe evacuation of maintenance personnel shall be described.

3.5.2.3 Form sheet for the maintenance report

The maintenance report shall document the execution of all checks and working steps of the maintenance process. For each check and working step, there shall be appropriate fields to be filled in, together with fields for recording measurement values and test results.

All adjustment settings and set values as well as the expected measurement results shall be specified.

The maintenance report may consist of several sub-reports (e.g. for primary components such as rotor blades or support structure).

The following fields shall be provided as a minimum:

- type identification of the tidal turbine
- serial number, operator and installation site of the tidal turbine
- persons present during maintenance
- weather conditions on the day of maintenance

- operating hours
- shut-down hours
- report on the execution of all working steps of the maintenance
- confirmation that all checks required to conclude maintenance have been completed
- parts replaced
- extra space for possible remarks or items outstanding
- date and signature of the person(s) responsible.

3.5.2.4 Maintenance plan

The maintenance plan shall present all required maintenance in tabular form and shall state the appropriate time sequence.

If the maintenance and inspection work is scheduled by using a database instead of tables, a printout of all maintenance work from this database for the tidal turbine lifetime shall be submitted to the customer.

If maintenance work is scheduled in regular intervals (e.g. quarterly, annually), it is helpful to compile a list of all working steps applicable in one interval.

3.6 Periodical inspections documentation

3.6.1 Objective and format

Periodical Inspections Documentation shall describe execution of regular inspection of the machinery, the safety devices and the structural integrity of the entire tidal turbine with involvement of the certification body to maintain the validity of the prototype or project certificate.

In addition to general requirements to onshore and offshore manuals, the Periodical Inspections Manual shall include:

- inspection plan
- checklist for the inspection.

3.6.2 Scope and content

3.6.2.1 Inspection plan

Inspection plan shall be based on

- building and operation permit
- approval and / or certification reports
- filled-out commissioning records, see Section 3.3
- operating manual and operating records, see Section 3.4
- records on preventive and condition-based maintenance, see Section 3.5
- reports of previous Periodical Inspections
- documentation of modifications / repairs to the tidal turbine and necessary approvals, if relevant

- reports of inspection of scour protection or seabed level

Inspection Plan shall state the components of the tidal turbine and correspondent inspection intervals for their Periodical Inspections.

Inspection intervals and components subject of inspections shall be stated in the Inspection Plan in due consideration of

- results of Failure Mode Identification and Risk Ranking
- results of the design assessment summarized in the Certification Reports related to the type certification as well as to site specific design assessment
- results of surveillance within manufacturing, transport, installation and commissioning
- results of maintenance works
- results of previous Periodical Inspections

During Periodical Inspection the complete tidal turbine including the rotor blades shall be inspected thoroughly. Following components are essential for the Periodical Inspections:

- rotor blades
- drive train
- nacelle and force- and moment-transmitting components
- seals, dehumidifiers
- hydraulic system, pneumatic system
- support structure
- foundation
- safety devices, outside lighting, sensors and braking systems
- control system and electrics including devices in power house
- condition Monitoring System
- corrosion protection
- scour protection
- interconnecting power cables

Working steps needed for maintenance or inspections shall be described. The descriptions may be supplemented by appropriate pictorial representations.

3.6.2.2 Checklist for the inspection

A specific checklist for the inspection shall be prepared on the basis of the Inspection Plan.

The checklist shall document the execution of all checks and tests. For each check and test there shall be appropriate fields for recording of the measurements and test results. The checklist shall also contain the assessment criteria.

4 SITE CONDITIONS AND CHARACTERISATION

4.1 Introduction

4.1.1 Definition

Site conditions consist of all natural phenomena which may influence the design of a horizontal axis tidal turbine by governing its loading, its capacity or both.

Site conditions cover virtually all environmental conditions at the site, including but not limited to meteorological conditions, oceanographic conditions, water depth, geotechnical conditions, seismicity, biology, and various human activities.

Guidance note:

The meteorological and oceanographic conditions which may influence the design of a horizontal axis tidal turbine consist of phenomena such as current, waves, water level and wind. Some of these phenomena may be mutually dependent. Currents and waves and their respective directions are part of the conditions that may govern the design.

Micro-siting of the horizontal axis tidal turbines within an array of tidal turbines requires that local blockage- effects from surrounding tidal turbines, the seabed, sea-surface and bounding channel walls including changes in flow velocity, turbulence intensity and wake effects be considered part of the site conditions for each individual tidal turbine in the array.

---e-n-d---of---G-u-i-d-a-n-c-e---n-o-t-e---

4.2 Current climate

4.2.1 Current conditions

For representation of current climate, a distinction is made between normal and extreme current conditions. The normal current conditions generally concern recurrent structural loading conditions while extreme current conditions represent rare external design conditions. Normal current conditions are primarily used as a basis for determination of fatigue loads, but also extreme loads from extrapolation of normal operational loads. Extreme current conditions are current conditions that can lead to extreme loads in the components of the tidal turbine, its support structure and the foundation.

Current speed vectors vary with water depth and time due to flow fluctuations caused by turbulence and tidal conditions. The HATT itself influences the current e.g. by shadow effects of the support structure or turbine wakes. The three vector components of the turbulent current velocity are defined as:

- streamwise: along the principal direction of the flow;
- transverse: horizontal and normal to the streamwise direction, and
- vertical: normal to both the longitudinal and transverse directions.

The normal current conditions are specified in terms of water density, a long term distribution of the 10 minute mean current speed, direction, a current shear in terms of a gradient in the mean current speed with respect to depth below the sea surface, and turbulence.

4.2.2 Parameters for normal current conditions

Current is represented by the 10-minute mean streamwise current speed U_{10} and the standard deviation σ_U of the current speed. In the short term, i.e. over a 10-minute period, stationary current conditions with constant U_{10} and constant σ_U are assumed to prevail.

Guidance note:

The 10-minute mean current speed U_{10} is a measure of the intensity of the current. The standard deviation σ_U is a measure of the variability of the current speed about the mean.

---e-n-d---of---G-u-i-d-a-n-c-e---n-o-t-e---

The arbitrary current speed under stationary 10-minute conditions in the short term follows a probability distribution whose mean value is U_{10} and whose standard deviation is σ_U .

The current turbulence intensity ($I_i = \sigma_i / U_{10}$) is defined as the ratio of the standard deviation σ_i of the streamwise, transverse and vertical velocity fluctuation components ($i = u, v, w$) to the mean streamwise velocity.

Guidance note:

Usually the turbulence intensity value is given as a percentage: 100 times σ_i / U_{10} , where $i = u, v, w$.

---e-n-d---of---G-u-i-d-a-n-c-e---n-o-t-e---

The short term 10-minute stationary current climate may be represented by a current spectrum, i.e. the power spectral density function of the current speed process that represents the structure of the turbulence, $S(f)$. $S(f)$ is a function of U_{10} and σ_U and expresses how the energy of the current speed is distributed between various frequencies.

4.2.3 Current data

The current conditions may be established by site specific measurements over a long period (several years), by using numerical models (hindcast) or a combination of both as well as other meteorological and oceanographic information.

The current may be generated by different physical phenomena, the main of which being:

- Tidal currents generated by the effect of astronomical bodies, represented as harmonic constituents, to generate.
- Current generated by the wind stress and atmospheric pressure gradient throughout a storm.
- Large-scale ocean currents driven by latitudinal distributions of winds and thermohaline ocean circulation (i.e. the Gulf Stream in the Atlantic Ocean).
- The coastal currents generated as a result of waves approaching the shore, e.g. longshore and rip currents.

Currents can be divided in regular currents, those as tidal and circulation currents, and non-regular or stochastic currents as wind or wave generated currents.

In cases where the current is dominated by the tides if long-term statistical data is limited reference current speeds may be obtained using harmonic analysis.



Guidance note:

Harmonic analysis assumes that tidal motion (be it flows or tidal elevation), generated by periodic differential gravitational forces, can be represented by the sum of a series of simple harmonic terms (tidal constituents) with each term being represented by an oscillation at a known frequency of astronomical origin. A tidal cycle is completed every 18.6 years.

Harmonic models depend on the ocean responding linearly to the tidal forcing and it must be recognised that oceans are also free to respond to local (meteorological) forcing. Nevertheless, harmonic analysis can be used with great effect to firstly evaluate astronomical tidal forcing components (constituents) at a site, given sufficient site measurements, and secondly to predict the long term flow variations at that site using a harmonic model.

---e-n-d---of---G-u-i-d-a-n-c-e---n-o-t-e---

Harmonic analysis does not consider the storm surge effect and this should be quantified for both water level and current speed.

For the case where harmonic analysis is used the following shall be reported:

- the analysis period used to derive the tidal constituents;
- choice of harmonic constituents, for instance using Rayleigh criterion;
- harmonic analysis software and methods used;
- prediction period;
- weather and other non-tidal influence.

Current speed data are depth-dependent. The mean streamwise current speed at the hub height of the tidal turbine shall be used as a reference. When current speed data for depths other than the reference hub height are not available, the current speeds at other depths can be calculated from the current speeds at the reference height in conjunction with a current speed profile below the still water level.

Where currents coexist with waves, the current speed profile is stretched and compressed with the water surface elevation.

The long-term distributions of U_{10} and σ_U shall be based on statistical data for the same averaging period that is used for the determination of loads.

Empirical statistical current data used as a basis for design must cover a sufficiently long period of time.

Guidance note:

Current speed data for the long-term determination of the 10-minute current speed U_{10} are usually available for power output prediction. Care should be taken if using this data, which generally is insufficient to establish directly a long-term determination of the 10-minute current speed U_{10} .

---e-n-d---of---G-u-i-d-a-n-c-e---n-o-t-e---

Characteristic values of the current velocity should be determined with due account of the inherent uncertainties.

Characteristic values of the current speed shall be determined with due account of blockage and wake effects owing to the presence of other tidal turbines upstream, such as in an array of tidal turbines.

Guidance note:

An array of tidal turbines generates its own current climate due to blockage and wake effects, and the current climate in the centre of the array of tidal turbines may therefore be very different from the ambient current climate. The layout of the array of tidal turbines has an impact on the current at the individual tidal turbines. The blockage is due to the presence of a combination of bounding free surface such as the sea surface, channel sidewalls and the sea bed. Blockage and wake effects in arrays of tidal turbines have additional types of flow unsteadiness compared to wind farms, such as due to the effect of passing waves in addition to current flow turbulence.

Usually, changes in the local flow field are to be expected due to blockage. Blockage effects imply an increase in the turbine thrust coefficient as the lateral spacing between turbines decreases. This effect may be significant when the spacing between the tidal turbines in the array of tidal turbines is 1.5 to 3 rotor diameters.

Generally, changes in the local flow field and in the ambient turbulence intensity are to be expected due to the wakes of upstream turbines. Wake effects will imply a considerably increased turbulence, reflected in an increased standard deviation σ_U of the current speed. This effect may be significant even when the spacing between the tidal turbines in the array of tidal turbines is as large as 10 rotor diameters (longitudinally). Wake effects in an array of tidal turbines may also imply a reduction in the 10-minute mean current speed U_{10} relative to that of the ambient current climate.

Wake effects in arrays of tidal turbines can dominate the fatigue loads in tidal turbine structures.

For assessment of wake effects in arrays of tidal turbines, the effects of changed tidal turbine positions within specified installation tolerances for the tidal turbines relative to their planned positions should be evaluated.

---e-n-d---of---G-u-i-d-a-n-c-e---n-o-t-e---

Sea water density remains somewhat stable through the range of temperatures that tidal turbines operate in. Although it is important to be aware of reference temperatures for structural design, unlike wind turbines current speed data are not usually specified for a specific reference temperature.

4.2.4 Current measurements

The type of instrument used is important in determining key parameters relating to the current speed and turbulence.

Guidance note:

Normally Acoustic Doppler Profilers (ADP) is used to characterise the flow conditions of a tidal turbines site. These instruments are nevertheless often used in conjunction with Acoustic Doppler Velocimeters (ADV) which give more accurate speed readings and hence used to calibrate the measurements from the ADP.

---e-n-d---of---G-u-i-d-a-n-c-e---n-o-t-e---

Requirements of ADP measurements are given in IEC 62600-200 Sec.7.2 with the addition of:

- measurement duration shall be as a minimum long enough to ensure capturing the turbine's cut-in and cut-out current speed,
- when harmonic analysis is used to predict tidal elevations and currents a minimum of 30 days length of site measurements is required to distinguish enough harmonic components
- quality assurance parameters of the measurement records shall be reported.

Guidance note:

The requirements in IEC 62600-200 are for power performance assessment of the tidal turbine which differs from the objective of this standard which is the design and fabrication of tidal turbines. The current measurements required for design in this standard shall focus on determination of extreme values for derivation of extreme loading and determination of long-term distribution for derivation of fatigue loading.

---e-n-d---of---G-u-i-d-a-n-c-e---n-o-t-e---

For further guidance in current speed measurement and instrumentation reference is made to DNV-RP-C205, IEC 62600-200 and EquiMar Project Deliverables 2.2 and 2.7.

4.2.5 Current modelling

The spectral density of the current speed process expresses how the energy of the current turbulence is distributed between different frequencies. The spectral density of the current speed process including wake effects from any upstream tidal turbines is ultimately of interest.

Site-specific spectral densities of the current speed process can be determined from available measured current data. When measured current data are insufficient to establish site-specific spectral densities, turbulence models are to be used. Models which are based on empirical relationships for wind should be justified if used. The turbulence model shall include the effects of varying current speed, shears and direction and allow rotational sampling through varying shears.

Guidance note:

Generally turbulence models based on empirical relationships for wind are used. From wind based models, von Karman gives the most control with the integral length scales which is ultimately of interest for designers.

---e-n-d---of---G-u-i-d-a-n-c-e---n-o-t-e---

The long term probability distributions for the current climate parameters U_{10} and σ_U that are interpreted from available data can be represented in terms of histograms, generic distributions or in terms of scatter plots. A typical representation consists of a distribution (histogram or generic) for the 10-minute mean current speed U_{10} in conjunction with a distribution of σ_U conditional on U_{10} . A scatter plot provides the frequency of occurrence of given pairs (U_{10}, σ_U) in a given discretisation of the (U_{10}, σ_U) space. Directionality of the current (ebb and flood) shall be considered in the distributions.

The current speed shear profile represents the variation of the current speed with depth. Different components of the total current speed have different speed profiles. Shear profile can change with changing depth average current speed.

The two main components of currents influencing HATTs fixed to seabed installed in shallow waters are wind induced currents and sub-surface currents. Coastal currents may locally reach

significant values. The total current velocity therefore can be described as sum of the different components of current velocities:

$$U_c(z) = U_{c,sub}(z) + U_{c,wind}(z) + U_{c,surf}(z)$$

When detailed field measurements are not available the variation of sub-surface current velocity with depth may be modelled as a simple power law, assuming current and direction. A power law current speed shear profile may as well be assumed:

$$U_{c,sub}(z) = U_{ref} \left(\frac{d+z}{h_{ref}} \right)^\alpha \text{ for } z \leq 0$$

Guidance note:

The current speed shear profile impacts turbine loading. It is possible that the current speed shear profile varies with the current direction.

Care should be taken when assuming a current speed shear profile. Site-specific observed current speed shear profiles are preferred to an assumed 1/7 power law profile. In some other cases where more complex current speed shear profiles are featured log-law or parabolic profiles could be observed.

The directional variation of current velocity over depth (twist of the speed shear profile) can be observed in sub-surface tidal currents. In general, twist of the speed shear profile is greatest at the lowest flow speeds. Recent measurements at a tidal site 50m deep show a total direction change (twist) of up to 20 degrees from seabed to sea surface.

---e-n-d---of---G-u-i-d-a-n-c-e---n-o-t-e---

The variation of wind generated current can be taken as either a linear profile from $z = -d_0$ to still water level,

$$U_{c,wind}(z) = U_{c,wind}(0) \left(\frac{d_0+z}{d_0} \right) \text{ for } -d_0 \leq z \leq 0$$

Wind generated current can be assumed to vanish at a distance below the still water level,

$$U_{c,wind}(z) = 0 \text{ for } z < -d_0$$

Where

$U_{c,wind}(z)$ = wind-driven current speed at level z

U_{ref} = speed at reference height

z = distance from still water level, positive upwards

d = water depth to still water level (taken positive)

d_0 = reference depth for wind generated current, $d_0 = 20\text{m}$

h_{ref} = reference height, positive upwards

α = exponent

In deep water along an open coastline, wind-generated current velocities at the still water level may, if statistical data are not available, be taken as follows:

$$U_{c,wind}(z) = k V_{1 \text{ hour}, 10 \text{ m}}$$

where $k = 0.015-0.03$ and $V_{1 \text{ hour}, 10 \text{ m}}$ is the 1 hour sustained wind speed at height 10m above sea level.

The estimation of the surf currents can be performed using numerical method (e.g. using a Boussinesq model considering fully coupled wave and current motions). As a simplification for near shore currents, which have a direction parallel to the shore line, the current velocity $U_{c,surf}$ at the location of breaking waves may be estimated using:

$$U_{c,surf} = 2 s \sqrt{g H_B}$$

where:

H_B = breaking wave height

g = gravity acceleration

s = beach slope.

The vertical velocity profile of the surf current can be taken as equal to the sub-surface current profile.

The natural variability of the current speed about the mean current speed U_{10} in a 10-minute period is known as turbulence and is characterised by the standard deviation σ_U . For a given value of U_{10} , the standard deviation σ_U of the current speed exhibits a natural variability from one 10-minute period to another. Caution should be exercised when fitting a distribution model to data for the standard deviation σ_U with the objective to obtain design values at particular quantiles of the distribution.

Long-term measurements from nearby sites may be transferred to the site in question using hindcast models if both sites are governed by the same climate and show similar morphology. The models shall account for:

- Current speeds, directions and profiles both regular (tidal) and storm generated.
- Standard deviation of current speed and spectral distribution of short term fluctuations.
- Medium term (diurnal) and long term variation of current speed and water level variation.
- Variation of water level, both regular and storm generated.
- Sea states (significant wave height and period) and their probability distribution (scatter diagram). Sea state directional distribution.
- Joint probability distribution of sea states and current/water level, if possible.
- Wind speeds and directions and their probability distribution.
- Sea ice.
- Water temperature range.
- Water density and salinity.

Current speed and direction shall be established for a range of water depths. Care has to be taken to allow sufficient time to include seasonal effects on current profiles and short term fluctuation (turbulence) of the current speed.

The temporal resolution of the model shall be in accordance with the current speed averaging period defined in [4.2.2].



The model shall be validated for the site of interest, with the validation process documented.

Detailed model calibration for a given site, in the form of quantification of error and uncertainty, shall be accounted for and reported.

For further guidance on current numerical models, reference is made to DNV-RP-C205 and EquiMar Project Deliverables 2.3 and 2.7.

4.2.6 Reference current conditions and reference current speeds

The turbulent current speed shall be represented with a characteristic standard deviation of current speed, $\sigma_{U,c}$ defined as the average of the standard deviation σ_U of the current speed conditioned on the 10-minute mean current speed at hub height.

The current speed is used for calculation of ultimate loads and fatigue loads. For fatigue load calculations a series of current speeds have to be considered, associated with different sea states and wind conditions. For cases where extreme environmental conditions are combined, current speeds with a specified return period are used. Current speeds for return periods of 5 and 50 years shall include sub-surface and wind induced current components as well as effects from storm surges.

Guidance note:

The requirement to combine events with return periods of 5 and 50 years could be relaxed when site specific joint probability distribution of sea states and current/water level are known.

---e-n-d---of---G-u-i-d-a-n-c-e---n-o-t-e---

For tidal turbines within tidal arrays, the effects of nearby turbines shall be considered.

4.3 Wave climate

4.3.1 Wave parameters

The wave climate is represented by the significant wave height H_S and the spectral peak period T_p . In the short term, i.e. over a 3-hour period, stationary wave conditions with constant H_S and constant T_p are assumed to prevail.

Guidance note:

The significant wave height H_S is defined as the average height (trough to crest) of the highest one-third waves in the indicated time period, also denoted $H_{1/3}$.

The peak period T_p is the wave period determined by the inverse of the frequency at which a wave energy spectrum has its maximum value. The peak period T_p can be related to the mean zero-up-crossing period T_z of the sea elevation. T_z is the average time interval between two successive up-crossings of the mean sea level.

---e-n-d---of---G-u-i-d-a-n-c-e---n-o-t-e---

The wave height H of a wave cycle is the difference between the highest crest and the deepest trough between two successive zero-up-crossings of the sea elevation process. The arbitrary wave height H under stationary 3-hour conditions follows a probability distribution that is a function of the significant wave height H_S .



The wave period T is defined as the time between two successive zero-up-crossings of the sea elevation past mean sea level. The arbitrary wave period T under stationary 3- or 6-hour conditions follows a probability distribution that is a function of H_S , T_p and H .

The wave crest height H_C is the height of the highest crest between two successive zero-up-crossings of the sea elevation process.

The short term 3- or 6-hour sea state may be represented by a wave spectrum, i.e. the power spectral density function of the sea elevation process, $S(f)$. $S(f)$ is a function of H_S and T_p and expresses how the energy of the sea elevation process is distributed between various frequencies.

The wave energy content in relevant sea states and its distribution over frequencies shall be considered. The power spectral density is useful for this purpose. Various power spectral density models exist, usually expressing the power spectral density in terms of sea state parameters such as the significant wave height H_S and the peak period T_p , where the peak period T_p is somehow related to the zero-upcrossing period T_z . For useful power spectral density models, reference is made to DNV-RP-C205.

Sea states dominated by wind-generated waves can usually be represented by one-peak power spectral density models. When swell components can be expected in addition to wind-generated waves, they may show up as a second spectral peak and these have to be properly represented in the power spectral density model. Caution must be exercised when modelling the power spectral density, because power spectral density models are often site-specific, having been developed based on site-specific data.

In the derivation of the sea state parameters the influence of shallow water effects depending on water depth shall be considered. In a sea state shallow water influences wave height and its distribution as well as the spectral density distribution of the waves. Individual wave kinematics become highly non-linear in shallow waters; see DNV-RP-C205.

The presence of high current flows in combination with waves leads to a wave-current interaction (e.g. can cause refraction of the waves, Doppler shifting, and in some cases for strong opposing currents, blocking of wave propagation) that is reflected in the variation of some of the parameters that describe waves such as steepness, height and period.

Wave spectral formulations and wave theories are developed for conditions without currents; the wave periods used are intrinsic periods. In the case of prevailing currents the waves are modified for an observer in a fixed position.

Current velocities are usually described to the still water level. Under wave influence a stretching technique shall be applied to extrapolate current velocities to the actual water surface, see DNV-RP-C205.

The most extreme wave conditions may occur concurrently with opposing currents.

For further guidance and useful wave-current interaction models, reference is made to ISO 19901-1 and EquiMar Project Deliverable 2.2.

Numerical metocean models may be used to simulate wave conditions, requirements for the numerical model are given in [4.2.5].

4.3.2 Wave measurements

For further guidance in wave measurement and instrumentation reference is made to DNV-RP-C205, IEC 62600-200 and EquiMar Project Deliverables 2.2 and 2.7.

4.3.3 Wave modelling

The total velocity of the water at a particular location (x, y, z) at the time t should be obtained by linear combination:

$$U_T = U_c + U_w$$

where U_c is the particle velocity due to current and U_w is the particle velocity due to wave.

For further guidance in wave modelling, reference is made to DNV-RP-C205.

4.3.3.1 Constrained wave method

For fatigue and extreme load cases, it is important to account for all effects: the stochastic nature of the wind and wave loading, the flexibility of the structure and the non-linearity of the waves. To account for these effects simultaneously, the use of the constrained wave method is recommended.

In the constrained wave method, the wave kinematics is calculated by embedding one non-linear regular wave into a series of irregular, linear waves.

4.3.4 Reference sea states and reference wave heights

4.3.4.1 Irregular sea state

Irregular sea states are used for calculation of ultimate loads and fatigue loads. Irregular sea states are characterised by a significant wave height, a peak period, a wave spectrum and a wave direction. For fatigue load calculations a series of sea states have to be considered, associated with different current speeds and wind conditions. The number and resolution of sea states shall be sufficient to predict the fatigue damage associated with the long-term distribution of metocean parameters. For cases where extreme environmental conditions are combined, sea states with a specified return period are used. Sea states with return periods of 1, 5 and 50 years are used in Table 5-4.

Guidance note:

Simulations shorter than 1 h may be applied for estimation of extreme events if this does not compromise extreme load statistics, e.g. six 10-min simulations. Constrained wave methods may be used in this case; see [4.3.3.1]. If a deterministic constrained wave is used, a minimum of 6 realizations shall be considered.

---e-n-d---of---G-u-i-d-a-n-c-e---n-o-t-e---

4.3.4.2 Regular waves

Regular waves can be used as an alternative to irregular sea states for some transient load cases used for calculation of ultimate loads. Regular waves are characterised by a wave height equal to the maximum wave height of the representative sea state, a range of periods and a wave direction.

4.4 Water level

4.4.1 Water level parameters

The still water level (SWL) consists of a mean water level in reference to chart datum in conjunction with tidal range and a wind and pressure induced storm surge. The tidal range is defined as the range between the highest astronomical tide (HAT) and the lowest astronomical tide (LAT), see Figure 4-1.

The mean water level (MWL) is defined as the arithmetic mean of all water levels measured over a long period (ideally 18.6 years).

Other relevant reference levels are the mean high water spring tide (MHWS), the mean low water spring tide (MLWS) and the total still water level (TSWL) associated with a given return period.

Guidance note:

HAT is the highest water level that can be predicted to occur under any combination of astronomical conditions, i.e. the level of high tide when all harmonic components causing the tide are in phase (every 18.6 years). LAT is the lowest water level that can be predicted to occur under any combination of astronomical conditions, i.e. the level of low tide when all harmonic components causing the tide are in phase.

The height of mean high water springs (MHWS) is the average of the heights of two successive high waters during those periods of 24 hours (approximately once a fortnight) when the range of the tide is greatest. The height of mean low water springs (MLWS) is the average height obtained by the two successive low waters during the same period.

In sites dominated by the tides, current and water elevation are highly correlated. Usually there is a phase difference between the water level maxima and the current speed maxima (i.e. they do not occur at the same time).

---e-n-d---of---G-u-i-d-a-n-c-e---n-o-t-e---

Storm surges are mostly wind generated and subsequently follow the wind directional and speed distribution. As a result they are randomly distributed in relation to the water level changes due to tides.

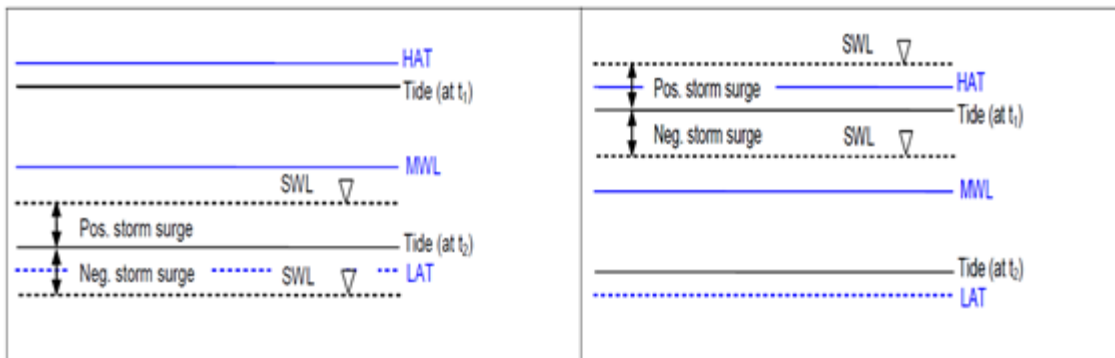



Figure 4-1 Definition of water levels when low still water level is governing (left) and when high still water level is governing (right)

For design purposes either a high water level or a low water level will be governing and both need to be considered. The high water level consists of an astronomical tide above MWL plus a positive storm surge component. The low water level consists of an astronomical tide below MWL plus a negative storm surge component.

Guidance note:

When a high water level is governing, usually a high water level with a specified return period will be needed for design. Likewise, when a low water level is governing, usually a low water level with a specified return period will be needed for design.



When the storm surge component at a location in question is insignificant and can be ignored, the water level will be governed by tide alone, and the maximum and minimum water levels to be used in design become equal to HAT and LAT, respectively.

---e-n-d---of---G-u-i-d-a-n-c-e---n-o-t-e---

4.4.2 Water level data

Water level statistics are to be used as a basis for representation of the long-term and short-term water level conditions. Empirical statistical data used as a basis for design must cover a sufficiently long period of time.

Guidance note:

Water level data obtained on site are to be preferred over water level data observed at an adjacent location. Measured water level data are to be preferred over visually observed water level data. Continuous records of data are to be preferred over records with gaps. Longer periods of observation are to be preferred over shorter periods.

---e-n-d---of---G-u-i-d-a-n-c-e---n-o-t-e---

In cases where the water level is dominated by the tides, if long-term statistical data is limited harmonic analysis for the prediction of tidal elevation may be used as outlined in [4.2.3].

Water level and wind are correlated, because the water level has a wind-generated component. The correlation between water level data and wind data shall be accounted for in design.

Guidance note:

Simultaneous observations of water level and wind data in terms of simultaneous values of water level and V_{10} should be obtained.

---e-n-d---of---G-u-i-d-a-n-c-e---n-o-t-e---

4.4.3 Water level measurements

In order to estimate the water level and its variations, measurements at the site should be performed. If hindcast models are used, long term measurements at nearby stations can be used. In the case that tides dominate water level variations, short time measurements at the site (1 month with correlation to long term measurements) can be sufficient to derive water level variations.

Water level may be affected by atmospheric forcing; these effects are referred to as storm surge. The estimation of the storm surges at a given site requires at least 10 years of measurements at the site or at nearby locations if hindcast models are used.

4.4.4 Water level modelling

For determination of the water level for calculation of loads and load effects, both tidal water and pressure- and wind-induced storm surge shall be considered.

Guidance note:

Water level conditions are of particular importance for prediction of depth-limited wave heights.

---e-n-d---of---G-u-i-d-a-n-c-e---n-o-t-e---

Numerical metocean models may be used to simulate water level conditions, requirements for numerical models are given in [4.2.5].

4.5 Wind climate

Wind is assumed not to represent a main source of loading for tidal turbines. Therefore only extreme wind conditions are considered in this standard.

The effect of wind is also considered in the wind induced current in [4.2.3].

4.5.1 Wind parameters

The wind climate is represented by the 10-minute mean wind speed V_{10} at a specified reference height. In the short term, i.e. over a 10-minute period, stationary wind conditions with constant V_{10} are assumed to prevail. The 10-minute mean wind speed V_{10} is a measure of the intensity of the wind.

Mean wind speeds based on other averaging periods than the 10 minutes referenced here can be used in principle for representation of the wind climate instead of the 10-minute mean wind speed V_{10} : e.g. the 1-hour mean wind speed. The 10-minute mean wind speed V_{10} is quoted because wind data are usually available in terms of this particular mean wind speed.

Appropriate conversions of the 10-minute mean wind speed to mean wind speeds with other averaging periods needs to be considered and implemented when combining wind data with wave data with other reference durations, such as 3 or 6 hours, and when performing simulations with other simulation lengths than 10 minutes.

4.5.2 Wind data

Wind speed statistics are to be used as a basis for representation of the long- and short-term wind conditions. Empirical statistical data used as a basis for design must cover a sufficiently long period of time.

Guidance note:

Site-specific measured wind data over sufficiently long periods with minimum or no gaps are to be sought. What is a sufficiently long period in this context depends on which current parameters are sought. Representativeness of the data for interpretation of the sought-after wind parameters is the key issue. For proper estimation of extreme values many years of data is a must, and generally the length of time covered by data should be long enough that sought-after key figures can be captured and extracted. For example, the mean value of the 10-minute mean wind speed is expected to exhibit variability from year to year such that several years of data are needed in order to understand this parameter. For other parameters, data covering shorter lengths of time may suffice. For example, turbulence conditioned on 10-minute mean wind speed and standard deviation of wind speed, and standard deviation conditioned on 10-minute mean wind speed.

---e-n-d---of---G-u-i-d-a-n-c-e---n-o-t-e---

4.5.3 Wind modelling

In this standard the wind can be represented by a steady model.

When detailed field measurements are not available the variation of wind velocity with height may be modelled as a simple power law, assuming wind and direction. A power law wind speed shear profile may as well be assumed:

$$V(z) = V_{ref} \left(\frac{z}{z_{ref}} \right)^{0.2}$$

4.5.4 Reference wind conditions and reference wind speeds

If applicable, wind loading shall be applied for the calculation of ultimate loads. For cases where extreme environmental conditions are combined, wind speeds with a specified return period are used. Wind speeds for return periods of 1, 5 and 50 years shall be used in combination with wind induced currents as appropriate.

4.6 Ice

In general, horizontal axis tidal turbines will be operating below water surface. For marine operations including installation and retrieval or in cases when the horizontal axis tidal turbine structure is piercing the water surface and is to be located in an area where ice may develop or where ice may drift, ice conditions shall be properly considered.

Relevant statistical data for the following sea ice conditions and properties shall be considered:

- geometry and nature of ice
- concentration and distribution of ice
- type of ice (ice flows, ice ridges, rafted ice, etc.)
- mechanical properties of ice (compressive strength r_u , bending strength r_f)
- velocity and direction of drifting ice
- thickness of ice
- probability of encountering icebergs.

The thickness of ice formed is an important parameter for calculation of ice loads. For useful ice load models, reference is made to DNV-OS-J101.

4.7 Seabed investigations and geotechnical data

4.7.1 Seabed investigations

The seabed investigations shall provide all necessary benthic/sediment data for a detailed design. The seabed investigations may be divided into geological studies, geophysical surveys and geotechnical investigations. Further details can be found in DNV Classification Notes No. 30.4, ISO 19901-8 or Eurocode 7.

Guidance note:

A geological study, based on the geological history, can form a basis for selection of methods and extent of the geotechnical investigations. A geophysical survey, based on shallow seismic, can be combined with the results from a geotechnical investigation to establish information about sediment stratification and seabed topography for an extended area such as the area covered by an array of tidal turbines. A geotechnical investigation consists of in-situ testing of sediment and of sediment sampling for laboratory testing of soil and rock.

---e-n-d---of---G-u-i-d-a-n-c-e---n-o-t-e---

The extent of seabed investigations and the choice of seabed investigation methods shall take into account the type, size and importance of the tidal turbine structure, the complexity of sediment and seabed conditions and the actual bottom type. The area to be covered by sediment investigations shall account for positioning and installation tolerances.



Guidance note:

The line spacing of the seismic survey at the selected location should be sufficiently small to detect all sediment strata of significance for the design and installation of the tidal turbine structures. Special concern should be given to the possibility of buried erosion channels with soft infill material.

The ground investigation should also be tailored to the design methods planned to be used.

---e-n-d---of---G-u-i-d-a-n-c-e---n-o-t-e---

For multiple foundations such as in an array of tidal turbines, the sediment stratigraphy and range of soil strength properties shall be assessed within each group of foundations or per foundation location, as relevant.

Guidance note:

Whether the sediment stratigraphy and range of sediment strength properties shall be assessed within each group of foundations or per foundation location is a function of the degree to which the soil deposit can be considered homogeneous. Thus, when very homogeneous conditions prevail, the group of foundations to be covered by such a common assessment may consist of all the foundations within the entire area of an array of tidal turbines or it may consist of all the foundations within a sub-area of an array of tidal turbines. Such sub-areas are typically defined when groups of tidal turbines within the array of tidal turbines are separated by kilometre-wide straits or traffic corridors. When complex or non-homogeneous ground conditions prevail, it may be necessary to limit common assessments of the sediment stratigraphy and strength properties to cover only a few close foundations, and in the ultimate case to carry out individual assessments for individual foundations.

---e-n-d---of---G-u-i-d-a-n-c-e---n-o-t-e---

Seabed investigations shall provide relevant information about the bottom sediment to a depth below which possible existence of weak formations will not influence the safety or performance of the tidal turbine and its support structure and foundation.

Guidance note:

For design of pile foundations against lateral loads, a combination of in-situ testing and sediment borings with sampling should be carried out to sufficient depth. For slender and flexible piles in jacket type foundations, a depth to about 10 pile diameters below pile tip suffices. For less flexible monopiles with larger diameters, a depth to half a pile diameter below the assumed maximum pile penetration suffices.

For design of piles against axial loads, at least one cone penetration test (CPT) and one nearby boring should be carried out to the anticipated penetration depth of the pile plus a zone of influence. If potential end bearing layers or other dense layers, which may create driving problems, are found this scope should be increased.

For design of gravity base foundations, the bottom sediment investigations should extend at least to the depth of any critical shear surface. Further, all sediment layers influenced by the tidal turbine structure from a settlement point of view should be thoroughly investigated. More thorough testing of the shallow top layers (for instance, by means of seabed PCPTs or vibrocores), may also be of relevance.



In seismically active areas, it may be necessary to obtain information about the shear modulus of the sediment to large depths.

---e-n-d---of---G-u-i-d-a-n-c-e---n-o-t-e---

4.7.2 Seabed investigations are normally to comprise the following types of investigation:

- site geological survey
- topography survey of the seabed
- geophysical investigations for correlation with sediment borings and in-situ testing
- sediment sampling with subsequent static and cyclic laboratory testing
- shear wave velocity measurements for assessment of maximum shear modulus
- in-situ testing, for example by cone penetration tests (CPT), pressiometer tests and dilatometer tests.

Guidance note:

The extent and contents of a seabed investigation program is not a straight-forward issue and the program will depend on the foundation type, on the site's conditions and also on the number of locations at the site. The guidance given here therefore provides recommendations of a general nature which the designer, either on his own initiative or in cooperation with the classification society, may elaborate further on.

An experienced marine geotechnical engineer who is familiar with the considered foundation concepts and who represents the owner or developer should be present during the sediment investigations on the site. Depending on the findings during the sediment investigations, actions may then be taken, as relevant, to change the seabed investigation program during its execution. This may include suggestions for increased depths of planned sediment borings, suggestions for additional sediment borings, and suggestions for changed positions of sediment borings.

When non-homogeneous soil or rock deposits are encountered or when difficult or weak sediments are identified locally, it may be necessary to carry out more sediment borings and CPTs than the tentative minimum recommended below.

For solitary tidal turbine structures, one sediment boring to sufficient depth for recovery of samples for laboratory testing is recommended as a minimum.

For tidal turbine structures in an array of tidal turbines, a tentative minimum ground investigation program may contain one CPT per foundation in combination with one boring for recovery of soil and rock samples for laboratory testing to sufficient depth in each corner of the area covered by the array of tidal turbines. An additional boring in the middle of the area will provide additional information about possible non-homogeneities over the area.

In cases where seabed conditions are highly varying within small spatial areas and foundations with a diameter of more than 20m are used, more than one soil boring or more than one CPT per tidal turbine position may be needed.

For cable routes, the seabed investigations should be sufficiently detailed to identify the surface sediments to the planned depth of the cables along the routes.



Seabed samples should be taken for evaluation of scour potential.

---e-n-d---of---G-u-i-d-a-n-c-e---n-o-t-e---

If the area, where the tidal turbine structure is to be installed, is determined to be seismically active and the support structure is likely to be affected by an earthquake, an evaluation shall be made of the regional and local geology in order to determine the location and alignment of faults, epicentral and focal distances, the source mechanism for energy release and the source-to-site attenuation characteristics. Local soil conditions shall be taken into account to the extent that they may affect the ground motion. The seismic design, including the development of the seismic design criteria for the site, shall be in accordance with recognised industry practice. For details of seismic design criteria, reference is made to ISO 19901-2 and to Eurocode 8-5.

For further guidance and industry practice regarding requirements for scope, execution and reporting of offshore seabed investigations, and equipment, reference is made to DNV Classification Notes No. 30.4, NORSOK N-004 (App. K), NORSOK G-001 and ISO 19901-8.. Other national and international standards may be considered from case to case, if relevant.

The geotechnical investigation at the actual site comprising a combination of sampling with subsequent laboratory testing and in situ testing shall provide the following types of geotechnical data for all important layers:

- data for soil and rock classification and description
- shear strength and deformation properties, as required for the type of analysis to be carried out
- in-situ stress conditions.

The soil and rock parameters provided shall cover the scope required for a detailed and complete foundation design, including the lateral extent of significant sediment layers, and the lateral variation of sediment properties in these layers.

It is of utmost importance that soil and rock samples obtained as part of a seabed investigation program are of a sufficiently good quality to allow for accurate interpretation of soil and rock parameters for use in design. For requirements to soil and rock sampling quality, soil or rock identification, groundwater measurements and regarding handling, transport and storing of samples, reference is made to ISO 22475-1.

The laboratory test program for determination of soil strength and deformation properties shall cover a set of different types of tests and a number of tests of each type, which will suffice to carry out a detailed foundation design.

Guidance note:

For mineral soils, such as sand and clay, direct simple shear tests and triaxial tests are relevant types of tests for determination of strength properties.

For fibrous peats, neither direct simple shear tests nor triaxial tests are recommended for determination of strength properties. Shear strength properties of low-humified peat can be determined by ring shear tests.

For friction of rocks laboratory shear tests shall be performed. The friction of the rocks are typically $\tau = \sigma \cdot \tan(\delta) < \tan(\varphi)$, Where σ is perpendicular to the shear plane. The δ will depend on the type of material you want to shear against the rock. Concrete and steel varies significant in δ for shear. The shear resistance depends on the size of the



fractures and the distance in between fractures. If it is a cast concrete, it gives a higher shear resistance in rocks for an uneven surface with a lot of fractures and cracks than a very strong rock without cracks.

---e-n-d---of---G-u-i-d-a-n-c-e---n-o-t-e---

In morphologically active areas, potential unfavourable long-term variation of the seabed (such as migration of sand waves, sand banks, ridges, megaripples or dunes, formation of pockmarks, etc.) should be considered, and if relevant, mitigation procedures should be employed

4.8 Other site conditions

4.8.1 Seismicity

The level of seismic activity of the area where the tidal turbine structure is to be installed shall be assessed on the basis of previous record of earthquake activity as expressed in terms of frequency of occurrence and magnitude.

For areas where detailed information of seismic activity is available, the seismicity of the area may be determined from such information. For areas where detailed information on seismic activity is not available, the seismicity is to be determined on the basis of detailed investigations, including a study of the geological history and the seismic events of the region.

The potential for earthquake-induced sea waves, also known as tsunamis, shall be assessed as part of the seismicity assessment.

For details of seismic design criteria, reference is made to ISO 19901-2.

4.8.2 Salinity

The salinity of the seawater shall be addressed as a parameter of importance for the design of cathodic protection systems.

4.8.3 Temperature

Extreme values of high and low temperatures are to be expressed in terms of the most probable highest and lowest values, respectively, with their corresponding return periods.

Both air and seawater temperatures are to be considered when describing the temperature environment.

4.8.4 Water and air density

Water and air density shall be addressed since it affects the structural design through hydrodynamic and wind loading. For actual density values, reference is made to DNV-RP-C205, Table F-1.

4.8.5 Marine growth

The plant, animal and bacteria life on the site causes marine growth on structural components in the water and in the splash zone. The potential for marine growth shall be assessed. Marine growth adds weight to a structural component and influences the geometry and the surface texture of the component. The marine growth may hence influence the hydrodynamic loads, the dynamic response, the accessibility and the corrosion rate of the component.

Marine organisms generally colonise a structure soon after installation, but the growth tapers off after a few years. The thickness of marine growth depends on the position of the structural component relative to the sea level, the orientation of the component relative to the sea level and relative to the dominant current, the age of the component, and the maintenance strategy

for the component. Marine growth also depends on other site conditions, such as salinity, oxygen content, pH value, current and temperature. Site-specific studies may be necessary in order to establish the likely thickness and depth dependence of the growth.

Guidance note:

Unless data indicate otherwise, the following marine growth profile may be used for design in Norwegian and UK waters:

Depth below MWL (m)	Marine growth thickness (mm)	
	Central and Northern North Sea (56° to 59° N)	Norwegian Sea (59° to 72° N)
-2 to 40	100	60
>40	50	30

Somewhat higher values, up to 150 mm between sea level and LAT -10 m, may be seen in the Southern North Sea.

The outer diameter of a structural member subject to marine growth shall be increased by twice the recommended thickness at the location in question.

The type of marine growth may have an impact on the values of the hydrodynamic coefficients that are used in the calculations of hydrodynamic loads from waves and current.

Whenever possible, site-specific measurements shall be used. This is particularly relevant for tidal turbine sites.

---e-n-d---of---G-u-i-d-a-n-c-e---n-o-t-e---

4.8.6 Sediments

Sediments present in the water column shall be addressed. In high current speed sites, entrained sediments can produce sandblasting effects on the turbine and its support structure affecting its coating.

4.8.7 Ship traffic

Risk associated with possible ship collisions shall be addressed as part of the basis for design of horizontal axis tidal turbines.

For service vessel collisions, the risk can be managed by designing the support structure against relevant service vessel impacts. For this purpose the limit state shall be considered as a ULS. The service vessel designs and the impact velocities to be considered are normally specified in the design basis for structural design.

Two different types of collision shall be identified,

- a) Underwater collision with the blades of a fully submerged horizontal axis tidal turbine
- b) Collision with the surface piercing support structure

4.8.8 Semi-submerged debris, marine mammal and fish collisions

The presence in the area of installation of semi-submerged debris, marine mammals and fish that could compromise the structural integrity of the HATT shall be considered in the design.

4.8.9 Disposed matters

The presence of obstacles, unexploded ordnances and wrecks within the area of installation shall be mapped.

4.8.10 Pipelines and cables

The presence of pipelines and cables within the area of installation shall be mapped.

4.8.11 Lightning

Lightning protection shall be provided to the relevant parts of the structure, including underwater structures, sea surface piercing structures and onshore installations.

Requirements for lightning protection are given in [12.9]

4.8.12 Electrical power network conditions

The electrical conditions shall be determined at the grid connection point between the tidal turbine and the existing electrical grid at the intended site, in order to ensure compatibility between the turbine and, where necessary, all electrical equipment located between the turbine and the grid. This shall include the following items at least:

- normal supply voltage and fluctuations
- normal supply frequency and fluctuations
- voltage symmetry
- symmetrical and asymmetrical faults
- number and type of the electrical grid outages and their average duration
- special features of the electrical grid at the site as well as requirements of the local grid operator shall be taken into account. These may be:
 - auto-reclosing cycles
 - short-circuit impedance at the connection points of the tidal turbine
 - harmonic voltage distortion from the turbine's power system.

The normal conditions to be considered at the tidal turbine terminals are listed in this section. Normal electrical power network conditions apply when the following parameters fall within the ranges stated below.

- voltage: nominal value ± 10 %
- frequency: nominal value ± 2 %
- voltage imbalance: The ratio of the negative-sequence component of voltage to the positive-sequence component shall not exceed 2 %.

Grid failures: Electrical network outages shall be assumed to occur 20 times per year.

Guidance note:

Deviations from the normal conditions in grid voltage and / or frequency are defined as grid disturbances or grid loss. Depending on the electrical parameters, the control system decides whether a grid disturbance or a grid loss has occurred. The parameters are defined in a site-specific manner.



The duration of a grid disturbance can vary between 0 seconds and approx. 1–2 minutes. As soon as normal conditions are reached again, the offshore wind turbine continues to operate normally.

---e-n-d---of---G-u-i-d-a-n-c-e---n-o-t-e---

Further details for normal conditions can be found in DIN EN 50160. If conditions differing from these normal conditions occur, e.g. because of regulations by the local utility, they have to be stated clearly.

5 LOADS AND LOAD EFFECTS

5.1 Introduction

5.1.1 General

In this section, loads, load components and load combinations to be considered in the overall strength analysis for design of tidal turbines and their support structures are specified. Requirements for the representation of these loads and their combinations as well as their combined load effects are given.

5.1.2 Extreme loads

Operational conditions during power production will often produce the governing extreme loads which will then be dominated by the thrust force formed by the rotor-filtered hydrodynamic loads. The largest thrust force usually occurs near the rated current speed, but will sometimes occur at other combinations of current, waves and water level. Dynamic loads at current speeds above the rated current speed are controller dependent. The largest extreme loads may not always be from normal power production. Peak loads can come from:

- Operating (power production, usually near rated current speed)
- Operating (power production with a fault)
- Parked (standing still or idling with a large wave)
- Transient events

Transients due to emergency stops may for example produce the highest stresses in the support structure.

All load conditions, during operation, in the parked condition and other transient conditions (start-up, shut-down) for the turbine; need to be included in a full long-term analysis for the extreme loads.

5.1.3 Fatigue loads

Fatigue damage of all components of the tidal turbine will be conditioned on the long-term load distributions.

In the case of tidal turbines within arrays of tidal turbines located downstream, wake effects should be considered for calculation of the fatigue loads.

5.1.4 Transportation loads

Transportation of horizontal axis tidal turbines may give rise to load cases, which shall be considered in design. Alternatively transportation loading may be accounted for as an additional fatigue contribution to the fatigue load cases defined in this standard.

5.1.5 Tidal turbine loads

Rotational sampling, consisting of the combination of current and waves experienced by a rotating point on the rotor and resulting from spatial variation of the turbulence and wave particle velocity over the swept area of the rotating turbine, will influence the cyclic loading and shall be considered in the design.

Transverse loads resulting from rotor to current flow misalignment or current flow to wave misalignment shall be considered in the design, as they can be important for a support structure with low resistance to overturning moments such as a gravity base structure.



Actuation loads resulting from the control and safety functions of the turbine, which include the response generated by the pitch and yaw systems, generator and/or inverter and braking system shall be considered in the design, as they are important throughout the lifetime of the turbine.

5.1.6 Blockage and wake-induced loads

Loads induced by wakes behind upstream tidal turbines in arrays of tidal turbines shall be considered in design.

Within arrays low-frequency turbulence may occur and cause sideways oscillations of wakes which may or may not hit downstream turbines and their structures. The possible consequences of such “meandering” wakes in terms of associated load cases should be considered in design.

Wake loads induced by other non-turbine objects upstream of the tidal turbines shall be considered in the design.

5.1.7 Other loads

Loads due to misalignment of the rotor with the current and waves shall be considered.

Other loads including ice, impacts from ships or marine mammals or fish shall be included if appropriate.

Blades are likely to be exposed to impact from the following sources (amongst others); mammals, semi-floating objects (e.g. sea debris), falling objects (either during installation, maintenance or impact from attending vessels), etc.

In cases where the turbine has a sea-surface piercing structure and located in an area where ice may develop or where ice may drift, ice loads shall be properly considered.

5.2 Design specific loads

5.2.1 Multiple turbines per supporting structure

Loads due to interactions between the operations of two or more turbines on a single support structure shall be considered.

Vibrations due to different rotational speeds or unsynchronised rotational regimes shall be considered.

Loads from the cases where the turbines are in different operational modes shall be considered. The DLC table in [5.6.3] shall be supplemented with the identified cases from [5.6.12].

Guidance note:

As an example, for the case where a single structure supports two turbines Table 5-4 needs to be supplemented for the cases where one turbine is operational and the other is parked. All possible combinations shall be addressed.

---e-n-d---of---G-u-i-d-a-n-c-e---n-o-t-e---

5.2.2 Multiple rotors

Turbines with multiple rotors can have complex load analysis. The DLC table in [5.6.3] shall be supplemented with all the identified cases to cover for this design feature from the failure mode identification and risk ranking.

Guidance note:

Multiple rotors imply a common PTO unit per turbine and multiple turbines implies independent PTO units.

---e-n-d---of---G-u-i-d-a-n-c-e---n-o-t-e---

5.2.3 Fixed yaw system

Fixed yaw turbines are more sensitive to the directionality of current and wave loads with regards to misalignment. The DLC table in [5.6.3] shall be supplemented with all the identified cases to cover for this design feature.

5.3 Basis for selection of characteristic loads

5.3.1 General

Loads are categorized according to type. The load categorization is used as the basis for definition of characteristic loads for use in design.

The following load categories are defined:

- permanent loads
- variable functional loads
- environmental loads
- abnormal tidal turbine loads (loads associated with fault situations for the tidal turbine)
- deformation loads
- accidental loads.

Guidance note:

Abnormal loads are loads resulting from a number of severe fault situations for the tidal turbine which result in activation of system protection functions. Abnormal loads due to fault conditions for the turbine have a higher probability of occurrence than accidental loads considered for the ALS. The appropriate limit state is applied depending on the type of fault and its associated probability of occurrence, abnormal loads due to fault conditions for the turbine may even have a higher probability of occurrence than typical ULS loads.

---e-n-d---of---G-u-i-d-a-n-c-e---n-o-t-e---

Unless specific exceptions apply, as documented within this standard, the basis for selection of characteristic loads or characteristic load effects specified in Table 5-1 and Table 5-2 shall apply in the temporary and operational design conditions, respectively.

Guidance note:

Temporary design conditions cover design conditions during transport, assembly, maintenance, repair and decommissioning of the tidal turbine structure.

Operational design conditions cover steady conditions such as power production, idling and stand-still as well as transient conditions associated with start-up, shutdown, yawing and faults of the tidal turbine.

---e-n-d---of---G-u-i-d-a-n-c-e---n-o-t-e---

For temporary design conditions, the characteristic loads and load effects in design checks shall be based on specified environmental design conditions as outlined in Table 5-1. The environmental design conditions shall be specified with due attention to the actual location, the season of the year, the weather forecast and the consequences of failure. For design conditions during transport and installation, reference is made to [5.6.16].

Guidance note:

Environmental design conditions are usually specified in terms of values for quantities such as significant wave height, mean current speed, and wind velocity. In the context of marine operations, environmental design conditions are referred to as environmental design criteria.

---e-n-d---of---G-u-i-d-a-n-c-e---n-o-t-e---

Table 5-1 Basis for definition of characteristic loads and load effects for temporary design conditions

Load category	Limit states – temporary design conditions				SLS
	ULS	FLS	ALS		
			Intact structure	Damaged structure	
Permanent (G)	Expected value				
Variable (Q)	Specified ⁽¹⁾ value	Specified ⁽¹⁾ load history	Specified ⁽¹⁾ value		
Environmental (E); weather restricted	Specified value	Expected load history	Not applicable	Specified value	
Environmental (E); unrestricted operations ⁽²⁾	Based on statistical data ⁽³⁾	Expected load history		Based on statistical data ^(3,4)	
Accidental (A)			Specified value		
Deformation (D)	Expected extreme value	Expected load history	Specified value		
(1) The specified value or the specified load history, as applicable, shall, if relevant, be justified by calculations. (2) See DNV-OS-H101. (3) See DNV-OS-H101, Sec.3. (4) Joint probability of accident and environmental condition could be considered.					

For operational design conditions, the basis for definition of characteristic loads and load effects specified in Table 5-2 refers to statistical terms whose definitions are given in Table 5-3.

Table 5-2 Basis for definition of characteristic loads and load effects for operational design conditions

<i>Limit states – operational design conditions</i>					
<i>Load category</i>	<i>ULS</i>	<i>FLS</i>	<i>ALS</i>		<i>SLS</i>
			<i>Intact structure</i>	<i>Damaged structure</i>	
Permanent (G)	Expected value				
Variable (Q)	Specified value				
Environmental (E)	98% quantile in distribution of annual maximum load or load effect (Load or load effect with return period 50 years)	Expected load history or expected load effect history	Not applicable	Load or load effect with return period not less than 1 year	Specified value
Accidental (A)			Specified value		
Abnormal	Specified value	Expected load history			
Deformation (D)	Expected extreme value				

Guidance note:

The environmental loading on support structures and foundations for tidal turbines does – as far as current and wave loading is concerned – not always remain the way it is produced by nature, because the control system of the tidal turbine interferes by introducing measures to reduce the loads.

---e-n-d---of---G-u-i-d-a-n-c-e---n-o-t-e---

Characteristic values of environmental loads or load effects, which are defined as the 98% quantile in the distribution of the annual maximum of the load or load effect, or by other quantiles in this distribution, shall be estimated by their central estimates.

Table 5-3 Statistical terms used for definition of characteristic loads and load effects

<i>Term</i>	<i>Return period (years)</i>	<i>Quantile in distribution of annual maximum</i>	<i>Probability of exceedance in distribution of annual maximum</i>
100-year value	100	99% quantile	0.01
50-year value	50	98% quantile	0.02
10-year value	10	90% quantile	0.10
5-year value	5	80% quantile	0.20
1-year value	-	Most probable highest value in one year, i.e. the mode in distribution of annual maximum	

5.4 Permanent loads (G)

5.4.1 General

Permanent loads are loads that will not vary in magnitude, position or direction during the period considered. Examples are:

- mass of structure
- mass of permanent ballast and equipment
- external and internal hydrostatic pressure of a permanent nature, including permanent pressure differences

- reactions to the above.

The characteristic value of a permanent load is defined as the expected value based on accurate data of the unit, mass of the material and the volume in question.

5.5 Variable functional loads (Q)

5.5.1 General

Variable functional loads are loads which may vary in magnitude, position and direction during the period under consideration, and which are related to operations and normal use of the installation. Examples are:

- personnel
- crane operational loads
- ship impacts
- loads from fendering
- loads associated with installation operations
- loads from variable ballast and equipment
- stored materials, equipment, gas, fluids and fluid pressure

For a fully submerged horizontal axis tidal turbine and support structure, the variable functional loads usually consist of:

- actuation loads
- fluid pressure
- loads from variable ballast and equipment (during installation and retrieval operations)

Additionally, for sea surface piercing tidal turbine structures, the following variable functional loads should be considered:

- loads on access platforms and internal structures such as ladders and platforms
- personnel
- ship impacts from service vessels
- crane operational loads.

The actuation loads are essential due to their influence on the turbine loads. They are in several categories including torque control from a generator or inverter, yaw and pitch actuator loads and mechanical braking loads. In each case, it is important in the calculation of loading and response to consider the range of actuator forces available. In particular, for mechanical brakes, the range of friction, spring force or pressure as influenced by temperature and ageing shall be taken into account in checking the response and the loading during any braking event.

The control and safety system functions comprise in detail functions of the control system (to operate the tidal turbine in all operational modes) as well as the safety system.

The control and safety system functions shall be developed according to the procedure detailed in Section 11 developed in the load simulation model and implemented in the tidal turbine.



The aspects of safety, functionality, performance and robustness shall be considered in the control and safety system functions. Attention shall be given to the interfaces between different subsystems, including the consequences of asynchronous operation where appropriate.

It shall be ensured that an appropriate linkage is maintained between the design of the control and safety system functions executed during the design phase (load simulations) and its implementation at the tidal turbine.

The safety, functionality, performance and robustness of the control and safety system functions shall be provided as a fault-tree diagram.

Actuation loads are usually represented as an integrated element in the tidal turbine loads that result from an analysis of the tidal turbine subjected to current and wave loading. They are therefore in this standard treated as environmental tidal turbine loads in [5.6.3] and do therefore not appear as separate functional loads in load combinations.

5.5.2 Ship impacts and collisions

Ship impact loads are not usually a concern for fully submerged tidal turbines. For cases where the tidal turbine structure pierces the sea surface ship collisions shall be treated as defined in DNV-OS-J101.

5.6 Environmental loads (E)

5.6.1 General

Environmental loads are loads which may vary in magnitude, position and direction during the period under consideration, and which are related to operations and normal use of the structure, such as

- hydrodynamic loads induced by waves and current, including lift, drag and inertia forces
- tidal effects (periodic change in hydrostatic load)
- wind loads
- loads due to the control and safety system functions
- marine growth
- earthquake loads
- snow and ice loads.

Practical information regarding environmental conditions and environmental loads is given in DNV-RP-C205 and in DNV-OS-J101.

Environmental loads and load effects to be used for design shall be based on environmental data representative for the target region and relevant for the operation in question. Environmental loads and load effects to be used for design shall be determined by use of relevant methods applicable for the target region and for the operation of the structure, and taking into account the type, size and shape of the structure as well as its response characteristics.

Characteristic loads and load effects shall be determined as quantiles with specified probabilities of exceedance in the respective relevant probability distributions.



To assist in the determination of environmental loads and associated structural responses (including actuation loads), it is recommended to carry out a coupled analysis in the time domain of the tidal turbine and its support structure.

Current and wave generated loads on the rotor and the support structure shall be considered. Current and wave generated loads on the rotor and the support structure include loads produced directly by the combination of the inflowing current and waves as well as indirect loads that result from the current- and wave combined loading generated motions of the tidal turbine and the operation of the tidal turbine. The direct current- and wave-generated loads consist of

- hydrodynamic blade loads (during operation, parked and transient conditions)
- hydrodynamic lift, drag and added mass forces on blades, support structure and nacelle.

The following loads, which are only indirectly produced by current and waves and which are a result of the operation of the tidal turbine, shall be considered as a combination of environmental loads in structural design according to this standard:

- gravity and buoyancy loads on the rotor blades, vary with time due to rotation
- centrifugal forces and Coriolis forces due to rotation
- reaction forces due to pitch and yaw systems
- braking forces due to braking of the tidal turbine.

Guidance note:

Hydrodynamic loads on the rotor, nacelle and the support structure may be determined by means of hydroelastic load models.

Gyroscopic loads on the rotor will occur regardless of structural flexibility whenever the turbine is yawing when the rotor is rotating and will lead to a yaw moment about the vertical axis and a tilt moment about a horizontal axis in the rotor plane.

---e-n-d---of---G-u-i-d-a-n-c-e---n-o-t-e---

For determination of hydrodynamic loads, the following factors shall be considered:

- tower shadow and vortex shedding, which are disturbances of the current flow owing to the presence of the support structure
- wake and blockage effects wherever the tidal turbine is located behind other turbines such as in arrays of tidal turbines or in constrained flow
- misaligned current flow relative to the rotor axis, e.g. owing to a yaw error
- misaligned wave direction relative to current flow and the rotor axis
- turbulence
- rotational sampling, i.e. low frequency turbulence will be transferred to high frequency loads due to blades cutting through vortices
- hydroelastic effects, i.e. the interaction between the motion of the turbine on the one hand and the current and wave field on the other
- hydrodynamic imbalance due to differences in blade set pitch angles

- rotor-mass imbalance
- influence of the control system on the tidal turbine, for example by limiting loads through blade pitching
- instabilities caused by stall-induced flap-wise and edgewise vibrations
- damping.

Guidance note:

The damping comes about as a combination of structural damping (material), hydrodynamic (radiation and viscous hydrodynamic) damping and soil damping for the case that the foundation is piled or drilled in the ground. The structural damping depends on the blade material and on the material of other components such as the support structure. The hydrodynamic damping can be determined as the outcome of a hydroelastic calculation in which correct properties for the hydrodynamics are used.

The coherence of the current and the turbulence spectrum of the current are of significant importance for determination of support structure loads such as the bending moment.

---e-n-d---of---G-u-i-d-a-n-c-e---n-o-t-e---

Tidal turbine loads during operation and selected transient events shall be verified by load measurements that cover the intended operational range after installation, i.e. current speeds between cut-in and cut-out. Measurements shall be carried out by an accredited testing laboratory or the certifying body shall verify that the party conducting the testing as a minimum complies with the criteria set forth in ISO IEC 17020 or ISO IEC 17025, as applicable. For more information about load measurements see [17.8].

5.6.2 Uncertainty in site conditions

Characterisation of site conditions for tidal turbines is, with the technology available today, somewhat difficult. Often measurements are not carried out during the length of time necessary to accurately derive long-term distributions or long-term extremes. Furthermore, the instruments which the measurements are taken from and the post processing methodology are often proved inaccurate. The uncertainty in site conditions impacts on the loading of the turbine. This standard deals with the uncertainty in site conditions with an additional partial safety factor, see Section 6.

5.6.3 Design load cases

For the design of all components of tidal turbine, a number of load cases due to environmental loads on the rotor and on the support structure shall be considered, corresponding to different design situations for the tidal turbine. Different design situations may govern the design of different parts of the turbine and support structure.

The load cases shall be defined such that it is ensured that they capture the 50-year load or load effect, as applicable, for each structural part to be designed in the ULS. Likewise, the load cases shall be defined such that it is ensured that they capture all contributions to fatigue damage for design in the FLS. Finally, the load case table shall include load cases to adequately capture abnormal and accidental conditions associated with severe fault situations for the tidal turbine and other risks identified during the risk analysis.

Table 5-4 specifies a minimum list of load cases to consider for tidal turbine load conditions and their companion load conditions: wave, current, wind and water level in order to fulfil the



requirements in this standard. The load cases in Table 5-4 refer to design in the ULS, ALS and in the FLS and include a number of abnormal load cases for the ULS.

The load cases in Table 5-4 are defined in terms of current conditions, which are characterised by current speed. For most of the load cases, the current speed is defined as a particular 10-minute mean current speed plus a particular turbulence intensity, which forms a perturbation on the mean current speed.

Table 5-4 shall be supplemented as necessary with load cases accounting for changes necessitated by specific designs of horizontal axis tidal turbines, such as devices with multiple turbines per supporting structure, turbines with multiple rotors and turbines with fixed yaw systems.

Guidance note:

For analysis of the dynamic behaviour of the tidal turbine and its support structure for concurrently acting current and waves, it is important to carry out the analysis using time histories of both current and waves or relevant dynamic amplification factors should be applied to a constant current speed or individual wave height.

---e-n-d---of---G-u-i-d-a-n-c-e---n-o-t-e---

Table 5-4 Proposed load cases combining various environmental conditions

Design Situation	Design condition	DLC	Limit States	Current conditions			Water Level	Wave conditions		Wind conditions
				Sub surface current	Wind induced current	Current Direction		Wave conditions	Wave and wind direction	
1. Power production	Normal operating conditions	1.1	ULS, FLS	$U_{in} \leq U_{10}$, $hub \leq U_{out}$	-	Flood, Ebb, OE	Associated tidal height	Irregular sea state with H_s = Annual distribution (scatter table) and W_{out}	Annual distribution	-
	Severe operation	1.2	ULS	U_{in} , $U_{r-0.2m/s}$, U_r , $U_{r+0.2m/s}$, U_{out}	-	Flood, Ebb, OE	Associated tidal height	Irregular sea state with H_s = W_{out}	30 degree steps	-
2. Power production plus occurrence of fault	Normal operating conditions (Normal faults)	2.1	ULS, FLS	$U_{in} \leq U_{10}$, $hub \leq U_{out}$	-	Flood, Ebb, OE	Associated tidal height	Irregular sea state with H_s = Annual distribution (scatter table) and W_{out}	Annual distribution	-
	Normal operating conditions (Abnormal faults)	2.2	ULSa	U_{in} , $U_{r-0.2m/s}$, U_r , $U_{r+0.2m/s}$, U_{out}	-	Worst direction from DLC 1.2	Associated tidal height	Irregular sea state with H_s = W_{out}	Worst direction from DLC 1.2	-
	Normal operating conditions (Accidental faults)	2.3	ALS	U_{in} , $U_{r-0.2m/s}$, U_r , $U_{r+0.2m/s}$, U_{out}	-	Worst direction from DLC 1.2	Associated tidal height	Irregular sea state with H_s = W_{out}	Worst direction from DLC 1.2	-
3. Start-up	Normal operating conditions	3.1	ULS, FLS	U_{in} , U_r , U_{out}	-	Flood, Ebb, OE	Associated tidal height	Irregular sea state with H_s = Annual distribution (scatter table) and W_{out}	Worst direction from DLC 1.2	-
	Severe operation	3.2	ULS	$U_{r-0.2m/s}$, $U_{r+0.2m/s}$, U_{out}	-	Worst direction from DLC 1.2	Associated tidal height	Irregular sea state with H_s , W_{out} or regular waves with $H = H_s, W_{out}$	Worst direction from DLC 1.2	-
4. Normal shutdown	Normal operating conditions	4.1	ULS, FLS	U_{in} , U_r , U_{out}	-	Flood, Ebb, OE	Associated tidal height	Irregular sea state with H_s = Annual distribution (scatter table) and W_{out}	Worst direction from DLC 1.2	-
	Severe operation	4.2	ULS	$U_{r-0.2m/s}$, $U_{r+0.2m/s}$, U_{out}	-	Worst direction from DLC 1.2	Associated tidal height	Irregular sea state with H_s , W_{out} or regular waves with $H = H_s, W_{out}$	Worst direction from DLC 1.2	-
5. Emergency shutdown	Severe operation	5.1	ULS	U_{in} , $U_{r-0.2m/s}$, $U_r, U_{r+0.2m/s}$, U_{out}	-	Worst direction from DLC 1.2	Associated tidal height	Irregular sea state with H_s , W_{out} or regular waves with $H = H_s, W_{out}$	Worst direction from DLC 1.2	-

Table 5-4 Proposed load cases combining various environmental conditions

Design Situation	Design condition	DLC	Limit States	Current conditions			Water Level	Wave conditions		Wind conditions
				Sub surface current	Wind induced current	Current Direction		Wave conditions	Wave and wind direction	
6. Parked (standing still or idling)	Normal parked conditions	6.1	ULS, FLS	$0 \leq U_{10}$, hub $\leq U_{out}$	-	Flood, Ebb, OE	Associated tidal height	Irregular sea state with Hs = Annual distribution (scatter table) and Wout	Annual distribution	-
	50 year current	6.2	ULS	U_{10} , hub = U_{10} , 50 years	5 yr	Flood, Ebb, OE	TSWL 50 years	Irregular sea state with Hs, 5 year	Most probable direction(s)	5 yr
	50 year wave	6.3	ULS	U_{10} , hub = U_{10} , 5 year	50 yr	Flood, Ebb, OE	TSWL 50 years	Irregular sea state with Hs, 50 year	Most probable direction(s)	50 yr
7. Parked with fault	Normal faults	7.1	ULS, FLS	$0 \leq U_{10}$, hub $\leq U_{out}$	-	Flood, Ebb, OE	Associated tidal height	Irregular sea state with Hs = Annual distribution (scatter table) and Wout	Annual distribution	-
	Abnormal faults	7.2a	ULSa	U_{10} , hub = U_{10} , 50 years	5 yr	Worst direction from DLC 6.2	TSWL 50 years	Irregular sea state with Hs, 5 year	Worst direction from DLC 6.2	5 yr
		7.2b	ULSa	U_{10} , hub = U_{10} , 5 years	50 yr	Worst direction from DLC 6.3	TSWL 50 years	Irregular sea state with Hs, 50 year	Worst direction from DLC 6.3	50 yr
	Accidental faults	7.3a	ALS	U_{10} , hub = U_{10} , 50 years	5 yr	Worst direction from DLC 6.2	TSWL 50 years	Irregular sea state with Hs, 5 year	Worst direction from DLC 6.2	5 yr
		7.3b	ALS	U_{10} , hub = U_{10} , 5 years	50 yr	Worst direction from DLC 6.3	TSWL 50 years	Irregular sea state with Hs, 50 year	Worst direction from DLC 6.3	50 yr
8. Transport, assembly, maintenance and repair		8.1	ULSa	Envelope of environmental conditions for maintenance to be defined by manufacturer						
	Severe operation	8.2	ULSa	U_{10} , hub = U_{10} , 1 year	1 yr	Flood, Ebb, OE	TSWL 1 year	Irregular sea state with Hs, 1 year (1)	30 degree steps	1 yr

Notes:

- 1) At least 1 year return period Hs, but if turbine stays parked for more than 30days then the return period of Hs will depend on the time before recovery. See Table 5-5.



Analysis of the load cases in Table 5-4 shall be carried out for justifiable assumptions of aligned current and waves or misaligned current and waves, or both, as relevant. Computer codes which are used for prediction of tidal turbine loads shall be validated for the purpose. The validation shall be documented.

Guidance note:

Validation to be based on tests on a tidal turbine of a similar technology and preferably on full scale tests rather than small scale tests. The validation should also include transient conditions.

Care should be taken on the post processing of the simulation data (numerical or physical tests) to avoid wrong conclusions even in the case where the physics were reproduced appropriately.

---e-n-d---of---G-u-i-d-a-n-c-e---n-o-t-e---

In general the maximum allowable orientation error (OE) shall be considered in addition to flood and ebb current directions.

For all DLCs, the effect of wind conditions only needs to be considered if effect likely to be significant.

For DLC 2.1 to 5.1, wind and wave directions should be chosen having identified the most severe direction(s) from DLC 1.2.

For DLC 7.2a and 7.3a, wind and wave directions should be chosen having identified the most severe direction(s) from DLC 6.2.

For DLC 7.2b and 7.3b, wind and wave directions should be chosen having identified the most severe direction(s) from DLC 6.3. For the cases to be included in the fatigue calculations the mean shear profile at each current speed shall be used.

Guidance note:

If a high variation of shear profiles for a single current speed and direction is observed a conservative assumption shall be made to predict the fatigue damage associated with the long-term distribution of current speed.

---e-n-d---of---G-u-i-d-a-n-c-e---n-o-t-e---

The discretization of the current speed intervals (bins) within the wind speed ranges to be investigated for fatigue and extreme load calculations shall not be chosen to be larger than 0.2 m/s.

5.6.4 Power production (DLC 1.1 to 1.2)

In this design situation, the tidal turbine is in operation and connected to the electrical load. No fault situation occurs and the control system is active. The assumed tidal turbine configuration shall take into account rotor imbalance. The maximum mass and hydrodynamic imbalances (e.g. blade pitch and twist deviations) specified for rotor manufacture shall be used in the design calculations.

Deviations from theoretical optimum operating situations, such as yaw misalignment and control system delays, shall be taken into account in the analyses of operational loads.



DLC 1.1 and 1.2 embody the requirements for loads resulting from current turbulence and stochastic sea states that occur during normal operation of tidal turbine throughout its lifetime. The misalignment of wind, wave and current shall be considered in this load case. In addition, the multidirectionality of metocean conditions shall be considered.

Irregular sea state conditions shall be assumed. The significant wave height, peak spectral period and direction for each normal sea state shall be selected, together with the associated mean wind speed (if relevant), based on the long-term joint probability distribution of metocean parameters appropriate to the anticipated site. It shall be ensured that number and resolution of the normal sea states considered are sufficient to account for the fatigue damage associated with the full long-term distribution of metocean parameters.

5.6.5 Power production plus occurrence of fault or loss of electrical network connection (DLC 2.1 - 2.3)

This design situation involves a transient event triggered by a fault or the loss of electrical network connection while the turbine is producing power. Any fault in the control and protection system, or internal fault in the electrical system, significant for tidal turbine loading (such as generator short circuit) shall be considered.

It may be assumed that independent faults do not occur simultaneously.

The rotor start positions which lead to the most unfavourable conditions for the tidal turbine shall be considered. The intervals between the rotor start positions shall be at most 30° for three-bladed turbines and 45° for two-bladed turbines.

For DLC 2.1, the occurrence of faults relating to control functions or loss of electrical network connection shall be considered as normal events.

The occurrence of a fault in the control system which is considered a normal event shall be analysed in DLC 2.1. Exceedance of the limiting values of the control system, yaw error, pitch deviation of the blades to each other shall be investigated.

Guidance note:

Faults with higher probability of occurrence, such as events with a probability class of 3 to 5 (from the FMEA results, see [1.10.3.3]) or faults triggering the control system including grid loss.

---e-n-d---of---G-u-i-d-a-n-c-e---n-o-t-e---

If a fault causes an immediate shut-down or the consequent loading can lead to significant fatigue damage, the probable number of shut-downs, or the duration of this extraordinary design situation, shall be considered in DLC 2.1. At least 10 shut-downs per year due to overspeed n_4 shall be considered.

The transient switching operations of the tidal turbine triggered by grid loss shall be considered with regard to the analysis of fatigue and extreme loads. To account for normal external conditions, at least 20 grid losses per year shall be assumed as a transient event in simulation. The manufacturer shall specify whether the expected number of occurrences exceeds 20 grid losses per year. Additionally in this load case, peculiarities arising from connection to an energy consumer (e.g. power limitations, frequency, voltage and load fluctuations in a weak grid, operation of mechanically powered machinery, grid failure and special requirements of the grid operator) shall be taken into account as applicable. Examples of influences on a tidal turbine are:

- power limitation for the tidal array / turbine
- major frequency, voltage and load fluctuations
- interference voltages
- short circuit in the grid
- special requirements of a grid operator (e.g. fault ride-through capabilities, auto-reclosing cycles)

For DLC 2.2, rare events, including faults relating to the protection functions or internal electrical systems shall be considered as abnormal.

The occurrence of faults in the safety system or in the internal electrical system which are considered to be rare events shall be analysed in DLC 2.2. Exceedance of the limiting values for the safety system, vibrations, runaway of the blade pitch, failure of a braking system or runaway of yaw shall be investigated. Furthermore, faults in the power system shall be investigated.

Guidance note:

Faults with lower probability of occurrence, such as events with a probability class of 1 and 2 (from the FMEA results, see [1.10.3.3]) or faults triggering the safety system.

---e-n-d---of---G-u-i-d-a-n-c-e---n-o-t-e---

For DLC 2.3, rare events, categorised as accidental events shall be considered.

Guidance note:

To be implemented with the events defined in [5.9] as relevant.

---e-n-d---of---G-u-i-d-a-n-c-e---n-o-t-e---

Irregular sea state conditions shall be assumed with the significant wave height shall be assumed equal to the wave out for ULS calculations.

5.6.6 Start up (DLC 3.1 to 3.3)

This design situation includes all the events resulting in loads on a tidal turbine during the transients from any standstill or idling situation to power production. The number of occurrences shall be estimated based on the control system behaviour.

For DLC 3.1 and 3.2 an irregular sea state shall be assumed. Alternatively, for DLC 3.2 regular waves can be assumed.

5.6.7 Normal shut down (DLC 4.1 to 4.2)

This design situation includes all the events resulting in loads on the tidal turbine during normal transitions from power production to parked (standstill or idling). The number of occurrences shall be estimated based on the control system behaviour.

For DLC 4.1 and 4.2 an irregular sea state shall be assumed. Alternatively, for DLC 4.2 regular waves can be assumed.

5.6.8 Emergency shutdown (DLC 5.1)

Loads arising from emergency shutdown shall be considered.

For DLC 5.1 an irregular sea state or regular waves can be assumed.

5.6.9 Parked (standstill or idling) (DLC 6.1 to 6.3)

In this design situation, the rotor of a parked tidal turbine is either in a standstill or idling condition. DLC 6.1 to 6.4 shall be analysed to determine ultimate loads, whereas DLC 6.1 and 6.4 should be considered for fatigue loading.

In DLC 6.1, the expected number of hours of non-power production time at a fluctuating load appropriate for each current speed where significant fatigue damage can occur to any component shall be considered. Particular account shall be taken of the resonant loading of the support structure due to excitation by the waves and influence by the low hydrodynamic damping available from the rotor in a standstill or idling condition. Irregular sea state shall be assumed. The significant wave height, peak spectral period and direction for each normal sea state shall be selected, together with the associated mean wind speed (if relevant), based on the long-term joint probability distribution of metocean parameters appropriate to the anticipated site. The designer shall ensure that the number and resolution of the normal sea states considered are sufficient to account for the fatigue damage associated with the full long-term distribution of metocean parameters.

For DLC 6.2 and 6.3, the combination of extreme current and wave conditions shall be such that the global extreme environmental action has a combined recurrence period of 50 years. Two cases are to be analysed,

- a) for DLC 6.2 the 5-year recurrence value of the significant wave height and the 5-year recurrence value of the mean wind speed with the 50-year recurrence value of the mean current speed;
- b) for DLC 6.3 the 50-year recurrence value of the significant wave height and the 50-year recurrence value of the mean wind speed with the 5-year recurrence value of the mean current speed

both combined with a total still water level with recurrence period of 50 years or a set of combined values with joint recurrence period of 50 years shall be taken. The averaging values of the significant wave height and the mean wind have to be adjusted to the simulation time length.

In DLC 6.1 irregular sea state conditions shall be assumed. The significant wave height, peak spectral period and direction for each normal sea state shall be selected, together with the associated mean wind speed (if relevant), based on the long-term joint probability distribution of metocean parameters appropriate to the anticipated site. It shall be ensured that number and resolution of the normal sea states considered are sufficient to account for the fatigue damage associated with the full long-term distribution of metocean parameters.

In DLC 6.2 and 6.3, the occurrence of the extreme design wave shall be considered. The extreme wave kinematics of non-linearity, wave breaking and possible slap and slam load shall be taken into account, see DNV-OS-J101 Sec 4 for further guidance on wave breaking and slamming loads.

5.6.10 Parked plus fault conditions (DLC 7.1 to 7.3)

This load case considers the parked conditions (standstill or idling) resulting from the occurrence of a fault. Deviations from the normal behaviour of a parked tidal turbine, resulting from faults on the electrical network or within the tidal turbine, shall require analysis. If any fault other than a grid failure produces deviations from the normal behaviour of the tidal turbine in parked situations, the possible consequences shall be considered. Grid failure in this case



shall be regarded as a fault condition and therefore need not be considered together with any other fault of the offshore wind turbine.

In DLC 7.1, a loss of the electrical power network at an early stage in the storm containing the extreme wave situation shall be assumed. Unless power back-up for the control and yaw system with a capacity of 6 h of tidal turbine operation is provided, the effect of a yaw misalignment of up to $\pm 180^\circ$ shall be analysed.

In case of a fault in the yaw system, yaw misalignment of $\pm 180^\circ$ shall be considered. For any other fault, yaw misalignment shall be consistent with DLC 7.1.

If a grid failure with duration up to 1 week may occur and no backup energy system or redundant electricity supply is provided, the behaviour of the mechanical brake, the safety and yaw system shall be considered adequately in the load assumptions.

In the case of a braking system failure (erroneous activation or non-activation), the most unfavourable braking torque (min. or max.) shall be considered.

In DLC 7.1, the expected number of hours of non-power production time due to faults on the electrical network or in the tidal turbine shall be considered for each current speed and sea state where significant fatigue damage can occur to any components. Particular account shall be taken of the resonant loading of the support structure due to excitation by the waves and influenced by the low hydrodynamic damping available from the rotor in a standstill or idling condition.

Irregular sea state conditions shall be assumed. The significant wave height, peak spectral period and direction for each normal sea state shall be selected, together with the associated mean wind speed (if relevant), based on the long-term joint probability distribution of metocean parameters appropriate to the anticipated site. It shall be ensured that number and resolution of the normal sea states considered are sufficient to account for the fatigue damage associated with the full long-term distribution of metocean parameters.

For DLC 7.1, the occurrence of faults relating to control functions or loss of electrical network connection shall be considered as normal events.

Guidance note:

Faults with higher probability of occurrence, such as events with a probability class of 3 to 5.

---e-n-d---of---G-u-i-d-a-n-c-e---n-o-t-e---

For DLC 7.2, rare events, including faults relating to the protection functions or internal electrical systems shall be considered as abnormal.

Guidance note:

Faults with lower probability of occurrence, such as events with a probability class of 1 and 2.

---e-n-d---of---G-u-i-d-a-n-c-e---n-o-t-e---

For DLC 7.3, rare events, including accidental events shall be considered as accidental.

Guidance note:

To be implemented with the events defined [1.10.3.3] as relevant.

---e-n-d---of---G-u-i-d-a-n-c-e---n-o-t-e---

For DLC 7.2 and 7.3, the combination of extreme current and wave conditions shall be such that the global extreme environmental action has a combined recurrence period of 50 years. Two cases are to be analysed,

- a) for DLC 7.2a and 7.3a the 5-year recurrence value of the significant wave height and the 5-year recurrence value of the mean wind speed with the 50-year recurrence value of the mean current speed;
- b) for DLC 7.2b and 7.3b the 50-year recurrence value of the significant wave height and the 50-year recurrence value of the mean wind speed with the 5-year recurrence value of the mean current speed

both combined with a total still water level with recurrence period of 50 years or a set of combined values with joint recurrence period of 50 years shall be taken. The averaging values of the significant wave height and the mean wind have to be adjusted to the simulation time length.

5.6.11 Transport, assembly, maintenance and repair (DLC 8.1 to 8.2)

For DLC 8.1, the manufacturer shall state all the wind and marine conditions and design situations assumed for transport, assembly on site, access, maintenance and repair of the tidal turbine. The maximum stated wind conditions and marine conditions shall be considered in the design if they can produce significant loading on the tidal turbine. The maximum values depend whether the operation is weather restricted or unrestricted, see [5.3.1].

For DLC 8.1, turbine braked or locked with possible pitch misalignment and yaw misalignment may be assumed.

Loads occurring during transport, assembly, access, maintenance and repair of a tidal turbine shall be taken into account:

- weight of tools and mobile equipment;
- loads from operation of cranes;
- mooring and fendering loads from vessels serving the tidal turbine.

In the case of conditions for maintenance, particular consideration shall be given to the effect of the various locking devices (e.g. blade pitching, rotor and yaw drive) and the maintenance position which may have been adopted.

For fixed tidal turbines with surface piercing structures, an operational boat impact may arise during operation of vessels in the vicinity. An impact with the dedicated maintenance boat shall be considered. The size of the maintenance vessel (displacement) shall be stated by the manufacturer and / or operator of the offshore wind farm project. See DNV-OS-J101 Sec. 4 for guidance on analysis of ship impacts and collisions.

The environmental conditions to be applied in conjunction with the operational boat impact shall correspond to the most severe conditions under which the maintenance boat is allowed to

approach the turbine. For the analysis, it can be assumed that the turbine can be stopped or brought to maintenance condition by remote control.

The maximum permissible significant wave height for vessel operations near the offshore wind turbine installation has to be stated in the operation manual. Any areas where vessels are not permitted to operate in close proximity should be specified in the operation manual.

In addition, DLC 8.2 shall include all transport, assembly, maintenance and repair turbine states that may persist for longer than one week but shorter than 30 days. This shall include a structure or parts of the structure as defined in the transport, assembly, maintenance and repair operation procedures. It shall be assumed that the electrical network is not connected in any of these states. Measures may be taken to reduce the loads during any of these states as long as these measures do not require the electrical network connection.

For DLC 8.2, turbine abandoned during maintenance may be assumed.

For the case where the transport, assembly, maintenance and repair turbine states or that the turbine is abandoned during maintenance, that may persist for longer than 30 days, the acceptable return periods for Hs in each sea state shall be estimated using Table 5-5.

Table 5-5 Acceptable return periods for Hs

<i>Reference Period, T_R</i>	<i>Return Period, T_d</i>
30 days < T_R ≤ 180 days	$T_d ≥ 5$ years
$T_R > 180$ days	$T_d ≥ 50$ years

5.6.12 Multiple rotor specific load cases

For the case of multiple rotor tidal turbines, Table 5-4 shall be supplemented with the combination of different operational conditions of each rotor.

In power production cases, DLC 1, every possible operational conditions combination shall be analysed. When at least one rotor is at power production, other rotors can be:

- Power production
- Parked
- Parked with fault
- Removed.

In power production plus occurrence of fault cases, DLC 2, every possible operational conditions combination shall be analysed. When at least one rotor is at power production plus occurrence of fault (including grid loss), other rotors can be:

- Power production
- Parked
- Parked with fault
- Removed.

In parked cases, DLC 6, every possible operational conditions combination shall be analysed. When at least one rotor is parked (standing still or idling), other rotors can be:

- Parked
- Parked with fault

- Removed.

In parked with fault cases, DLC 7, every possible operational conditions combination shall be analysed. When at least one rotor is parked with fault, other rotors can be:

- Parked with fault.

5.6.13 Ice loads

Ice load cases are proposed in DNV-OS-J101, Section 4 and in GL Guideline for the certification of Offshore Wind Turbines 2012 Sec.4 when ice loads are relevant for design.

5.6.14 Water level loads

Tidal level and storm surge effects shall be considered in evaluation of responses of interest. Higher water levels tend to increase hydrostatic loads and current loads on the structure; however, situations may exist where lower water levels will imply the larger hydrodynamic loads due to wave penetration. Higher mean water levels also imply a decrease in the available airgap to access platforms and other structural components which depend on some minimum clearance.

Guidance note:

In general, both high water levels and low water levels shall be considered, whichever is most unfavourable, when water level loads are predicted.

For prediction of extreme responses, there are thus two 50-year water levels to consider, viz. a low 50-year water level and a high 50-year water level. Situations may exist where a water level between these two 50-year levels will produce the most unfavourable responses. This is especially relevant for sites where wave breaking is occurs.

---e-n-d---of---G-u-i-d-a-n-c-e---n-o-t-e---

Secondary effects produced by tides and storm surges such as the increase in current speed due to the existing correlation between current speed and water level shall be considered.

5.6.15 Scour

Usually tidal turbines structures are installed in areas where the seabed is constantly washed by high speed currents and therefore only solid rock is left. As a result of this effect scour is not a main concern when designing the foundation. However global scour due to travelling sand waves may have to be accounted for, as it would have direct implications on the water depths at the tidal array and consequently in hydrodynamic loading and structural dynamic response. For determination of scour load effects, reference is made to DNV-OS-J101, Section 4.

5.6.16 Loads during load-out, transport and installation

Determination of loads for tidal turbines during load-out, transport and installation can be done using the guidance for wind turbines. However some differences must be considered; usually tidal turbines are installed closer to shore and in places where high currents are regularly observed. For determination of loads during load-out, transport and installation, reference is made to DNV-OS-J101, Section 4.

5.6.17 Fatigue loads

The long term current and wave environment can be represented by a number of discrete conditions. Each condition consists of a reference current direction, a reference wave direction and a reference sea state characterized by a significant wave height, peak period, mean current speed, standard deviation of current speed and current speed shear profile (and mean wind



speed, and standard deviation of wind speed, if relevant). The probability of occurrence of each of these conditions must be specified. A sufficient number of reference directions shall be defined, in order to provide a good representation of the directional distribution of a long-term wave environment. The necessary number of reference sea states can be in the range of 10 to 50. Fatigue damage prediction can be sensitive to the number of sea states in this discretization, and sensitivity studies can be necessary.

Guidance note:

The number of reference sea states depends on the site and also on the level of detail of the information.

A minimum of 12 reference directions for the incoming wave may be taken. All directions should be considered to start with and justification is necessary if eliminated.

---e-n-d---of---G-u-i-d-a-n-c-e---n-o-t-e---

All significant stress ranges, which contribute to fatigue damage in the turbine components, shall be considered. Stress ranges caused by environmental loading and its interaction with the control and safety system shall normally be established by time domain analysis.

Stress ranges caused by current and wave loading shall be established from site-specific environmental data. The actual alignment of the rotor axis of the tidal turbine relative to the direction of the current and waves can be important.

Stress ranges caused by abnormal tidal turbine loads shall be considered as appropriate. Stresses from persistent errors, such as sensor errors in the turbine control system, and from relatively frequently occurring faults might be relevant.

If frequency domain analysis is used, validation against model tests or time domain analysis shall be performed.

Dynamic effects, including dynamic amplification, shall be duly accounted for when establishing the long-term stress range distribution.

5.7 Combination of Environmental Loads

5.7.1 General

This section gives requirements for combination of environmental loads in all design conditions specified in Table 5-4.

The requirements refer to characteristic tidal turbine loads based on an investigation of the load cases specified in Table 5-4 and Table E3 in DNV-OS-J101.

For each tidal turbine component assessed and each load case in Table 5-4 shall be verified for the SLS and for the most critical limit state as indicated in the table.

For ULS design, the characteristic environmental load effect shall be taken as the 98% quantile in the distribution of the annual maximum environmental load effect, i.e. it is the load effect whose return period is 50 years, and whose associated probability of exceedance is 0.02. When the load effect is the result of the simultaneous occurrence of two or more environmental load processes, these requirements to the characteristic load effect apply to the combined load effect from the concurrently acting load processes. The subsequent items specify how concurrently acting environmental loads can be combined to arrive at the required characteristic combined load effect.



Environmental loads are loads exerted by the environments that surround the structure. Typical environments are current, waves, water level, wind, and ice, but other environments may also be thought of such as temperature and ship traffic. Each environment is usually characterized by an intensity parameter. Current is usually characterized by the 10-minute mean current speed, waves by the significant wave height, water level by the 10-minute mean water level, wind by the 10-minute mean wind speed, and ice by the ice thickness.

5.7.2 Linear combinations of current load and wave load

The combined load effect in the structure due to simultaneous current, wave and wind loads may be calculated by combining the separately calculated wind load effect and the separately calculated current and wave load effect by linear superposition. Care needs to be taken when using this approach, unlike wind turbines wave process is present in blade loading and therefore needs to be considered in the rotor loads for tidal turbines. Useful information on linear combination of two load processes is given in DNV-OS-J101, Section 4.

5.7.3 Combination of current load and wave load by simulation

Loads described in [5.6] shall be considered for design. Dynamic simulations utilizing a structural dynamics model are usually used to calculate tidal turbine load effects. Certain load cases have a stochastic current and/or sea state input. The total period of load data, for these cases, shall be long enough to ensure statistical reliability of the estimate of the characteristic load effect. In general, at least six 10-min stochastic realizations shall be required for each mean, hub-height current speed and sea state considered in the simulations. However, for transient load cases, DLC 2.1, 2.2, 2.3, 2.4 and 5.1, at least twelve 10-minutes simulations shall be carried out for each at the given current speed specified design load case.

For load cases with specified deterministic current field and wave events the characteristic value of the load effect shall be the worst case computed transient value. If more simulations are performed at a given current speed and sea state, representing the rotor azimuth, the characteristic value is taken as the average value of the worst case computed transient values. When turbulent inflow is used together with irregular sea states, the mean value among the worst case computed load effects for different stochastic realisations shall be taken, except for DLC 2.1, 2.2, 2.3, 2.4 and 5.1, where the characteristic value of the load effect shall be the mean value of the largest half of the maximum load effects.

If large variation is observed among the stochastic realisations for a given current speed and sea state methods for reduction of the variation in maximum load should be applied. These methods should be based on conservative assumptions of timing of events, e.g. fault event, wave, rotor azimuth, stochastic current field, etc.

5.7.4 Basic load cases

When information is not available to produce the required characteristic combined load effect directly, the required characteristic combined load effect can be obtained by combining the individual characteristic load effects due to the respective individual environmental load types. In Table 5-6 is specified a list of load cases that shall be considered when this approach is followed, thereby to ensure that the required characteristic combined load effect, defined as the combined load effect with a return period of 50 years, is obtained for the design. Each load case is defined as the combination of two or more environmental load types. For each load type in the load combination of a particular load case, the table specifies the characteristic value of the corresponding, separately determined load effect. The characteristic value is specified in terms of the return period.

Table 5-6 Proposed load combinations for load calculations

		<i>Environmental load type and return period to define characteristic value of corresponding load effect</i>				
<i>Limit state</i>	<i>Load combination</i>	<i>Wind</i>	<i>Waves</i>	<i>Current</i>	<i>Ice</i>	<i>Water level</i>
ULS	1	50 years	50 years	5 years		50 years
	2	5 years	5 years	50 years		50 years
	3	50 years		5 years	50 years	MWL

Guidance note:

Table 5-6 forms the basis for determination of the design combined load effect according to the linear combination format in [5.7.2]. Table 5-6 refers to a characteristic combined load effect with a return period of 50 years and shall be used in conjunction with load factors specified in Section 6.

When it can be assumed that a load effect whose return period is T_d occurs during the environmental state whose return period is T_d , then the tabulated recurrence values in Table 5-6 can be used as the return period for the load intensity parameter for the load type that causes the particular load effect in question. With this interpretation, Table 5-6 may be used as the basis for determination of the characteristic combined load effect by linear combination. When the direction of the loading is an important issue, it may be of particular relevance to maintain that the return periods of Table 5-6 refer to load effects rather than to load intensities.

For determination of the 50-year water level, two values shall be considered, viz. the high water level which is the 98% quantile in the distribution of the annual maximum water level and the low water level which is the 2% quantile in the distribution of the annual minimum water level. For each load combination in Table 5-6, the most unfavourable value among the two shall be used for the 50-year water level.

---e-n-d---of---G-u-i-d-a-n-c-e---n-o-t-e---

Every time a load combination is investigated, which contains a load effect contribution from current load, the load combination shall be analysed for two different assumptions about the state of the tidal turbine:

- tidal turbine in operation (power production)
- parked tidal turbine (idling or standing still).

The largest load effect resulting from the corresponding two analyses shall be used for design.

The multi-directionality of the current and the waves may in some cases have an important influence on the loads acting on the turbine, depending primarily on whether the support structure is axisymmetric or not. For some design load cases the load calculations may be undertaken by assuming that the current and the waves are acting co-directionally from a single, worst case direction.

Characteristic extreme current and wave load effects are in this standard defined as current and wave load effects with a 50-year return period. 5-year current and wave load effects form part of some load combinations.

5.7.5 Transient load cases

Actuation loads from the operation and control of the tidal turbine produce transient loads on the tidal turbine. The following events produce transient loads and shall be considered:

- start up from stand-still or from idling
- normal shutdown
- emergency shutdown
- normal fault events: faults in control system and loss of electrical network connection
- abnormal fault events: faults in protection system and electrical systems
- yawing.

The characteristic combined current and wave load effect shall be calculated as the maximum load effect during a 10-minute period. In which the current intensity shall be taken as the most unfavourable 10-minute mean current speed in the range between the cut-in speed and the cut-out speed and the wave intensity as the most unfavourable 3h significant wave height and associated peak period. If the simulation time is shorter than 3h (usually 10 minutes) then methods to embed the highest possible wave occurring in 3h (constrained wave) shall be used.

The characteristic transient current load effect shall be combined with the 10-year wave load effect. The combination shall be worked out by direct simulation of the characteristic combined load effect in a structural analysis in the time domain for simultaneously applied simulated time series of the current load and the wave load.

When transient current loads are combined with wave loads, misalignment between current and waves shall be considered. For non-axisymmetric support structures, the most unfavourable current load direction and wave load direction shall be assumed.

5.7.6 Load combination for the fatigue limit state

For analyses of the fatigue limit state, a characteristic load effect distribution shall be applied which is the expected load effect distribution over the design life. The expected load effect distribution is a distribution of stress ranges and mean loads owing to load fluctuations and contains contributions from current, waves, wind, ice and water level as well as from possible other sources. The expected load effect distribution shall include contributions from

- tidal turbine in operation
- parked tidal turbine (idling and standing still)
- start up
- normal shutdown
- control, protection and system faults, including loss of electrical network connection
- transport and assembly prior to putting the tidal turbine to service
- maintenance and repair during the service life.

For fatigue analysis of a foundation pile, the characteristic load effect distribution shall include the history of stress ranges associated with the driving of the pile prior to installing the tidal turbine and putting it to service.

For further guidance on load combination for the fatigue limit state reference is made to DNV-OS-J101 Section 4.

5.8 Load effect analysis

5.8.1 Definition

Load effects, in terms of motions, displacements, and internal forces and stresses in the tidal turbine structure, shall be determined with due regard for:

- their spatial and temporal nature including:
- possible non-linearities of the load
- dynamic character of the response
- the relevant limit states for design checks
- the desired accuracy in the relevant design phase.

For fully restrained structures a static or dynamic current-wave-structure-foundation analysis is required.

The same requirements additional as for wind turbines shall apply for tidal turbines in load effect analysis. These requirements are given in DNV-OS-J101 Section 4.

5.9 Accidental loads (A)

5.9.1 Definition

Accidental loads are loads related to accidental events, abnormal operations or technical failure, i.e. events that occur more rarely than the 50- or 100-year loads usually used as characteristic loads for design in the ULS. Characteristic accidental loads are accordingly selected such that they have annual exceedance probabilities in the range 10^{-4} to 10^{-2} . Unless specified otherwise, characteristic accidental loads for tidal turbines and their support structures shall be taken as 1000-year loads, i.e. loads with an annual probability of exceedance of 10^{-3} . For tidal turbines, accidental loads are foreseen first of all to be loads due to

- collision impacts (vessel, marine mammals and fish, or other objects)
- unintended change in ballast distribution (e.g. failure of active ballast system)
- change of intended pressure difference
- dropped objects
- debris impact (fishing nets, plastic waste, floating logs, etc.)
- fire and explosions
- accidental flooding.

This list should be supplemented with the accidental loads resulting from the failure mode identification and risk ranking as defined in [1.10.3.3].

Accidental loads from unintended collisions with drifting service vessels shall be considered and shall adhere to [5.5.2] and shall meet the requirements specified in DNV-OS-J101, Section 4.

Accidental loads from dropped objects shall be considered as they can be expected from normal maintenance operations where objects are lifted and at the risk of being dropped.



5.10 Deformation loads (D)

5.10.1 General

Deformation loads are loads caused by inflicted deformations such as

- temperature loads
- built-in deformations
- settlements of foundations

Requirements for deformation loads are given in DNV-OS-J101 Section 4.

6 LOAD & RESISTANCE FACTORS

6.1 Load factors

6.1.1 Load factors for the ULS

Table 6-1 provides three sets of load factors to be used when characteristic loads or load effects from different load categories are combined to form the design load or the design load effect for use in design. For analysis of the ULS, the sets denoted (a) and (b) shall be used when the characteristic environmental load or load effect is established as the 98% quantile in the distribution of the annual maximum load or load effect.

Table 6-1 Load factors γ_f for the ULS

Load factor set	Limit state	Load categories					D
		G	Q	E			
				Risk / Safety class			
				Low	Normal	High	
(a)	ULS	1.25	1.25	0.7 (***)			1.0
(b)	ULS	1.0 (**)	1.0 (**)	1.1 (*)	1.35 (*)	1.60 (*)	1.0
(c)	ULS for abnormal load cases	1.0 (**)	1.0 (**)	1.1			1.0
(d)	ALS	1.0 (**)	1.0 (**)	0.9	1.0	1.15	

Load categories are:

G = permanent load

Q = variable functional load, normally relevant only for design against ship impacts and for local design of platforms

E = environmental load

D = deformation load

For description of load categories, see Section 5.

(*) Environmental loads (E) are to be multiplied by the site factor in [6.2] ranging from 1.0 to 1.25 to obtain the total load partial factor to be used.

(**) When a permanent load (G) or a variable functional load (Q) is a favourable load, then a load factor of 0.9 shall be applied for this load in combinations (b) and (c) instead of the value of 1.0 otherwise required. The only exception from this applies to favourable loads from foundation soils in geotechnical engineering problems, for which a load factor of 1.0 shall be applied. A load is a favourable load when a reduced value of the load leads to an increased load effect in the structure.

(***) When environmental loads are to be combined with functional loads from ship impacts, the environmental load factor shall be increased from 0.7 to 1.0 to reflect that ship impacts are correlated with the wave conditions.

The characteristic environmental load effect (E), which forms part of the load combinations of Table 6-1, is to be taken as the characteristic combined load effect, determined according to Sec.5, and representing the load effect that results from two or more concurrently acting load processes.

6.1.2 Load factor for the FLS

The structure shall be able to resist expected fatigue loads, which may occur during temporary and operational design conditions. Whenever significant cyclic loads may occur in other phases,

e.g. during manufacturing and transportation, such cyclic loads shall be included in the fatigue load estimates.

The load factor γ_f in the FLS is 1.0 for all load categories.

6.1.3 Load factor for the SLS

For analysis of the SLS, the load factor γ_f is 1.0 for all load categories, both for temporary and operational design conditions.

6.1.4 Load factor for the ALS

The load factor γ_f for the ALS is 1.0.

6.1.5 Special partial safety factors

For temporary phases such as transport, assembly, maintenance and repair, described in [5.3] a load factor of 1.35 shall be used

6.2 Uncertainties associated with site characterisation data

The load factors given in [6.1] were calibrated considering a level of uncertainty that it is not affected by the way and duration that the data for site characterisation is carried out. An additional factor γ_s considering this additional impact is described in [5.6.2] and, in lieu of specific data, values are given in Table 6-2:

Table 6-2 Site factors γ_s for ULS

Characterization	γ_s
Statistically derived with several years' data from the location.	1.0
1 month measurements at site	1.05
Incomplete measurements at site	1.25

Site factors are to be applied on top of the load factors given in 6.1.1[6.1.1].

6.3 Resistance factors

6.3.1 Resistance factors for the ULS

Resistance factors for the ULS are given in the relevant sections for design in the ULS. These resistance factors apply to design of support structures and foundations which qualify for design to normal safety class.

For design of support structures and foundations to high safety class, the same resistance factors as those required for design to normal safety class can be applied, provided that the load factors for environmental loads are taken in accordance with [6.1.1]

6.3.2 Resistance factors for the FLS

Material factors as such are not specified for the FLS. Design against the FLS is based on a format which makes use of an overall Design Fatigue Factor (DFF) applied to a characteristic cumulative damage. Requirements for design fatigue factors for the FLS are given in the relevant sections for design in the FLS see [8.1.7.4].

6.3.3 Resistance factors for the ALS and the SLS

The material factor γ_m for the ALS and the SLS shall be taken as 1.0.

7 MATERIALS FOR STRUCTURES AND BLADES

7.1 Introduction

7.1.1 General

Material specifications shall be established for all structural materials utilized in a HATT structure. Such materials shall be suitable for their intended purpose and have adequate properties in all relevant design conditions. Material selection shall be undertaken in accordance with the principles given in DNV-OS-J101.

When considering criteria appropriate to material grade selection, adequate consideration shall be given to all relevant phases in the life cycle of the unit. In this context there may be conditions and criteria, other than those from the in-service, operational phase, which may govern the design requirements with respect to the selection of materials. Such criteria may, for example, consist of design temperature and stress levels during marine operations.

In structural cross-joints essential for the overall structural integrity where high tensile stresses are acting normal to the plane of a plate, the plate material shall be tested to prove the ability to resist lamellar tearing (Z-quality).

Material designations are defined in DNV-OS-J101.

For structural characterisation the reference to consequence of structural failure should be replaced with risk associated to the structural failure.

7.2 Selection of metallic materials

7.2.1 General

For selection, structural categorisation and material certificate requirements of structural steel for design and construction of support structures, reference is made to the materials section of DNV-OS-J101 Sec.6.

7.2.2 Structural steel and aluminium

Materials for

- rolled steel for structural applications and pressure vessels
- steel tubes, pipes and fittings
- steel forgings
- steel castings

shall comply with the requirements set forth in DNV-OS-J101 Sec.6.

Stainless steel shall have a maximum carbon content of 0.05%. The stainless steel material shall be in the white pickled and passivated condition.

Aluminium shall be of seawater resistant type. Aluminium alloys shall comply with the requirements set forth in DNV-OS-B101 Ch.2 Sec.5.

7.2.3 Bolting materials

Bolting materials for structural applications shall in general be carbon steels or low-alloy steels with the limitation that the hardness and strength class shall not exceed ISO 898 Class 8.8. For



bolting materials to be used in HATT support structure, the hardness and strength class shall not exceed ISO 898 Class 10.9.

Guidance note:

Bolts in accordance with ASTM A320 Grade L7 are acceptable within given limitations.

---e-n-d---of---G-u-i-d-a-n-c-e---n-o-t-e---

7.3 Selection of concrete materials

7.3.1 General

For selection of concrete materials for design and construction of HATT support structures, reference is made to the materials section of DNV-OS-J101 Sec.6. Useful information for selection of concrete materials can also be found in DNV-OS-C502 Sec.4.

7.4 Selection of grout materials

7.4.1 General

For selection of grout materials for design and construction of grouted connections in support structures, reference is made to the materials section of DNV-OS-J101 Sec.6.

7.5 Selection of composite materials

7.5.1 General

Owing to their favourable weight properties, composite materials such as fibre-reinforced plastic laminates and sandwich constructions may prove attractive for construction of selected structural components HATT structures. For selection of composite materials, reference is made to DNV-OS-C501.

7.6 Selection of materials for solid ballast

7.6.1 General

The type and use of permanent ballast for stability purposes, for example within the internal compartment of a spar unit, must be carefully evaluated with respect to long term effects such as those related to corrosion and washout. When selecting solid ballast material, caution must be exercised to avoid materials such as contractant sands which are susceptible to liquefaction and which may shift location in the liquefied condition and compromise the stability.

7.7 Materials for blades

7.7.1 General

7.7.1.1 General requirements for blade materials

Only suitable materials with guaranteed properties (e.g. strength, toughness, resistance to marine environment etc.) may be used for the structural components of rotor blades.

Materials chosen shall be matched to the demands of the component, particularly the type of load (shock load, oscillating load etc.) as well as the external conditions and the design. Special effects that may occur in the submarine environment (e.g. erosion, contact corrosion where carbon fibre reinforced plastics and steel are in use) shall be taken into account when the materials for the design are selected. The materials chosen shall be distinguished clearly and

comprehensively in the documentation (drawings, specifications, material test reports, parts lists) to be submitted for certification.

All surfaces and cutting edges of submerged structures shall be protected permanently against surrounding media by application of appropriate coatings. Furthermore, all surfaces shall be protected from marine growth by application of appropriate coatings.

Considerations about the impact of water depth, i.e. hydrostatic pressure, should be taken into account on water absorption tests.

7.7.1.2 Characteristic material properties

It is assumed that material properties such as strength and stiffness are normally distributed. If the properties of a material deviate significantly from the assumption of a normal distribution, a different set of safety factors than specified herein shall be used.

In the context of composite materials, the characteristic strength (R_k) is given by the lower limit of the population's 5th percentile with a 95% confidence. The 5th percentile corresponds to a value below which only 5% of the population is expected to lie.

In practise, strength characterisation is conducted through a test program with a finite sample number (n) of individual tests. The aim of the test program is to estimate the mean (μ) and variance (σ^2) of the population's probability distribution.

As only a finite number of specimens in the sample will be tested (n), the uncertainties in estimating the population's probability distribution parameters from sample values shall be accounted for using statistical methods.

The test program should firstly determine the key statistical parameters of the sample: (sample mean), and s^2 (sample variance).

$$\bar{x} = \frac{1}{n} \sum_i x_i$$

and

$$s^2 = \frac{1}{n-1} \sum_i (x_i - \bar{x})^2$$

where:

x_i the i -th individual test result

n number of specimen test results in the sample

\bar{x} sample mean

s^2 sample variance

Population variance (σ^2) known – k_1 . In the case of known variance, and normally (Gaussian) distributed strength, the characteristic strength is to be calculated as follows:

$$R_k = \bar{x} - k_1 \sigma$$

where:

k_1 can be determined by the formula below, or taken from the values given in Table 7-1.

σ is the known standard deviation (square root of variance) of the population.

$$k_1 = Z_{\frac{\alpha}{2}} \left(1 + \frac{1}{\sqrt{n}} \right)$$

where

$Z_{\frac{\alpha}{2}}$ can be taken as 1.645 for a 95% confidence.

Guidance note:

This is not a typical assumption for composites, however, it can be used provided with technical argumentation.

---e-n-d---of---G-u-i-d-a-n-c-e---n-o-t-e---

Population variance (σ^2) unknown - k_2 . In the case of unknown variance, and normally (Gaussian) distributed strength, characteristic strength is to be calculated as follows:

$$R_k = \bar{x} - k_2 s$$

where:

k_2 values given in Table 7-1.

s is the sample standard deviation (square root of variance) of the tested sample.

Table 7-1 k_1 and k_2 for 5th percentile lower limit, 95% confidence, normal distribution

n	k_1	k_2
5	2.38	4.21
6	2.32	3.71
7	2.27	3.4
8	2.23	3.19
9	2.19	3.03
10	2.17	2.91
11	2.14	2.82
12	2.12	2.74
13	2.1	2.67
14	2.08	2.61
15	2.07	2.57
20	2.01	2.4
50	1.88	2.07
100	1.81	1.93
⋮	⋮	⋮
∞	1.645	1.645

Guidance note:

Other more advanced statistical methods and assumptions may be used to determine characteristic values when provided with appropriate justification, e.g. if the assumption of a normal distribution is not appropriate, or if the use of more advanced statistical methods is expected to result in higher R_k values.

Assuming a population variance unknown is a realistic approach for composite materials.

---e-n-d---of---G-u-i-d-a-n-c-e---n-o-t-e---

7.7.1.3 Quality system requirements

Only materials, whose characteristic values and properties have been verified by the manufacturer by means of inspection documents shall be used. The following inspection documents according to EN 10204 (ISO 10474) are required as a minimum:

- EN 10204-2.2 Fibre products, gelcoat resins, paints
- EN 10204-2.3 Laminating resins, prepregs, core materials, adhesives

For raw materials (fibre products, resins, adhesives etc.) that are received at a manufacturers work shop / store rooms, incoming goods inspections shall be performed. During the incoming inspection, the goods shall at least be checked for any damage and for compliance of the details in the certificates with the requirements. Material values shall be checked by random sampling.

All materials shall be stored in accordance with the requirements of the manufacturer.

It shall be proven that the materials used in production do attain characteristic strength values above the nominal values for strength verification. Other material values (i.e. moduli) assumed within calculation/verification shall be within a defined acceptance criterion set by the designer.

7.7.1.4 General requirements for any blade material testing

To determine the strength and the stiffness of materials used for structural members at allowable water temperatures between -2°C and $+30^{\circ}\text{C}$, at least the tests mentioned below shall be performed by a laboratory either accredited according to IEC ISO 17025 or acknowledged by the certification body. If operating temperature goes beyond the aforementioned temperature range, material testing shall be performed in order to prove that the materials used are suitable to withstand the operating temperature.

The test methods/standards mentioned (in the following sections) are to be considered as recommended and preferred test methods for blade materials. Other test methods than the ones described here may be used if they measure the same physical properties under the same conditions.

It is generally recommended to obtain data from material combinations that represent the actual product and processing methods as closely as possible.

Strains shall be measured directly on the specimen with extensometer or strain gauge, and/or reliable non-contact test methods.

The test results, after being statistically processed to gain characteristic values see [7.7.1.2], may be used as guidance values for the nominal values chosen for the strength verification of the structural components to be used in the blades.

Regarding the stiffness/mass distribution, the design values shall be adequately represented for the purpose of load and natural frequency calculation.

7.7.2 Fibre-reinforced plastic materials

7.7.2.1 General testing information

The heat deflection temperature of the neat laminating resin shall be determined according to ISO 75-2 with a minimum of 3 specimens.

The water absorption of the laminating resin shall be determined according to ISO 62 (specimen $50 \times 50 \times 2 \text{ mm}^3$) and shall not exceed 50mg after 168h and 100mg after 28 days of immersion in water.

The laminating resins shall show a media resistance to

- distilled water and sea water (salinity 2.5%) for exposure duration of 1000h according to ISO 175,
- water condensation for exposure duration of 720h according to ISO 6270-1,

- neutral salt spray (5% salinity) for exposure duration of 1440h according to ISO 9227.

All mechanical tests shall be performed with specimens conditioned to a saturation of 98% (this may be depending on the specimen dimensions, thicker specimens may not be able to reach such a saturation level) in seawater as well as with “dry” specimens (it is recommended conditioned in normal climate 23/50 as defined in ISO 291) with minimum exposure duration of 1000h in order to determine the influence of the marine environment on the mechanical properties.

The representative fibre, resin and void volume fraction shall be determined for all samples used in the following (mechanical) tests (according to ISO 1172). The maximum fibre volume fraction shall not exceed 55%, as a rule and 60% for all resin systems.

As ply thickness is entirely dependent on matrix content, and axial strength is typically dominated by fibre content, the test data must be corrected for ply thickness variations (fibre volume) to get representative strength results. This is done through normalisation of the strength and moduli properties for a specified constant fibre volume. Poisson’s ratio, 90° axis, and in-plane / Inter-laminar shear characteristics are not fibre dominated and therefore do not require data normalisation.

One approach for data normalisation is known as the Cured Ply Thickness (CPT) approach, which relies on the direct relationship between Fibre Volume (FV) and the CPT. Here, test data at different achieved FVs can be normalised to a common FV. This approach can be carried out according to the following or equivalent method:

$$F_{normalised} = F \cdot \frac{CPT \cdot \rho_f}{FAW} \cdot FV_{normalising}$$

where the FV to which the data is to be normalised is given by:

$$FV_{normalising} = \frac{h_{fn}}{CPT_n}$$

where:

h_{fn} = equivalent thickness of the solid reinforcement fibre in one ply (normalising value)

CPT_n = Cured Ply Thickness, the total laminate thickness divided by the number of plies (normalising value)

and:

F = strength property under consideration

CPT = Cured Ply Thickness, the total laminate thickness divided by the number of plies

$FV_{normalising}$ = is the design specified (nominal) fibre volume for the lamina/laminate

ρ_f = is the density of the fibre

FAW = Fibre Areal Weight of a single lamina/ply (i.e., the mass of fibre in a unit area of lamina/ply)

7.7.2.2 Coupon level ultimate strength qualification for composites

The tensile properties of the laminate parallel and perpendicular to the (main) fibre direction shall be determined according to ISO 527-4 / -5 (it is recommended at normal climate 23/50 as defined in ISO 291) with a minimum of 6 specimens. The tests shall be evaluated for tensile strength, failure strain, Young’s modulus and Poisson’s ratio.



When evaluating the tensile strength of composites with unidirectional fibres perpendicular to the test load direction, the stress-strain curve shall be analysed for the point of the first occurrence of inter fibre failure.

The compressive properties of the laminate parallel and perpendicular to the (main) fibre direction shall be determined according to ISO 14126 (it is recommended at normal climate 23/50 as defined in ISO 291) with a minimum of 6 specimens. The tests shall be evaluated for compressive strength, failure strain, Young's modulus and Poisson's ratio.

The shear properties of the laminate shall be determined according to ASTM D7078 (it is recommended at normal climate 23/50 as defined in ISO 291) with a minimum of 6 specimens. The alignment of the fibres in the specimens shall be in a way so that the loading in the tests is representative to the shear loading of the respective material during operation of the blade. The tests shall be evaluated for shear strength, failure shear strain and shear modulus. Other tests:

- ILSS ISO 1430 /ASTM D 2344 could also be included.
- Hardness (Shore D/Barcoll)
- Impact Strength ISO 179

7.7.2.3 Coupon level S-N curve development

The amounts of load levels, specimens per load level, and load cycles given in the following are minimum values:

The geometry of test specimens for fatigue testing shall be according to ASTM D 3039 or ISO 527-4. Other geometries can be used but shall be agreed with the certification body prior to the testing.

The S-N curve is to be developed based on characteristic material properties.

The temperature of the specimens should be monitored to avoid heating of the specimen due to testing at too high frequencies. It is recommended that heating of coupons should be less than 10C with reference to the testing temperature.

Failure criterion is failure of the specimen. Failure or rupture of the specimen is defined when there is a sudden drop in the load carrying capacity of the blade or a change of 5% of stiffness/compliance change. If those two values are very close, the minimum value shall be used.

For glass and carbon fibre reinforced plastics, fatigue test are performed according to ASTM D3479 at $R=0.1$. The ASTM D3479 fatigue test method deals with tension-tension fatigue only. For R-ratios of $R = -1$, and $R = 10$, careful consideration should be given to the testing method to avoid laminate bending and buckling under compression $R=-1$ and $R=10$.

In case anti-buckling devices are used during the tests, it shall be made sure that they do not influence the test results in a non-conservative way.

7.7.2.4 Simplified calculation methods

If no S-N data is available, simplified calculation methods are allowed under the following assumptions:

- Assuming an inverse slope of the S-N-line of $m=8$ (glass/polyester and glass/epoxy), or $m=14$ (carbon/epoxy).

- Structures whose load-bearing laminate is built up from unidirectional glass-fibre reinforcement layers may be qualified with regards to short-term and fatigue strength by a simplified strain verification. As design values of the actions, the strain along the fibre direction shall remain below the following design values:
 - For glass-fibre laminates: tensile strain ≤ 0.35 % and compressive strain $\leq | -0.25$ % |
 - For carbon-epoxy laminates: tensile strain ≤ 0.24 % and compressive strain $\leq | -0.18$ % |
- Note: it is strongly recommended that those suggested values are verified by testing.

7.7.2.5 Element level qualification

Following an initial global analysis of the structure, critical areas within the blade structure will become evident. These critical areas can then be further evaluated through element level testing. This may include such tests as stacked laminates representing critical beam and web cross-sections along the blade length. The effects of holes and notches on the laminate may also be investigated at this level to provide greater understanding of the element response.

The two following cases shall be distinguished:

- In case the identified critical areas cannot finally be verified by means of computation, element level testing shall be mandatory. For this, clear criteria for successful / non-successful results shall be defined prior to the testing. The set of criteria shall be agreed with the certification body before commencing test execution.
- Element level tests may be used in order to increase the confidence in the analysis or to verify certain assumptions made for the analysis. For this, after test execution and evaluation, conclusions shall be drawn. These shall be used to either confirm the a priori assumptions or to modify the assumptions for the analysis according to the outcome of the testing.

The element level test specimen shall represent the respective critical area within the blade structure. The number of specimens to be tested in each case shall be a reasonable compromise between time invested, effort and statistical certainty.

7.7.2.6 Detail level qualification / sub-component testing

The design can be further investigated and qualified at the detail level through additional testing and analysis, to gain further confidence in structural and sub-component details. This may be required to investigate complex structural arrangements (such as hub attachment and flange bonding) under complex three dimensional loading conditions.

Tests at the detail level usually cannot be performed based on standards. Test set-up and execution need to be developed by the designer in each individual case and shall be agreed with the certification body before commencing test execution. The number, size and level of detail of the test samples shall be a reasonable compromise between approximation to reality and suitable effort.

7.7.2.7 Full scale testing

The purpose of the full scale test is a final validation of the numerous design assumptions made through the design development, and the qualification plan. It is a more representative application of the expected design conditions in service, and accurately takes into account global



effects. The full scale test results should also be compared against the original design analysis as further validation.

Further details on the full scale testing requirements are provided in Section 17.

7.7.3 Sandwich structures

7.7.3.1 General

Core materials shall be proved to be suitable for the intended purpose and shall not impair the curing of the laminating resin compound. Especially for rigid plastic foam, the permissible material temperature may not be exceeded when curing the laminating resin.

When designing sandwich core materials for underwater applications, the possible diffusion of water through the skin sheets shall be considered. Water diffusion through the laminate may degrade the core properties. If core materials are sealed to reduce or minimize water absorption, this shall be documented

Rigid plastic foam used as core material for sandwich laminates or as reinforcing webs shall have a closed-cell structure and shall be highly resistant to the laminating resin and the adhesive, as well as to ageing and to marine (and industrial) environments. Other requirements are a low water absorption capacity and a raw density being sufficient for the intended purpose of use.

End-grain balsa intended for use as core material for sandwich laminates shall meet the following requirements:

- It shall be treated with fungicide and insecticide immediately after felling.
- It shall be sterilized and homogenized.
- It shall be kiln-dried within ten days of felling.
- It shall be completely sealed in the component, in order to avoid any possible water uptake.
- It shall be dry before use (to a percentage between 12-15%).

Notes on core material use in underwater environments

- Crosslinked PVC cores and specially sealed and treated end grain balsa cores have demonstrated no degradation in a marine environment when embedded in typical laminates. Some documentation with respect to the resistance to a sea water environment shall be provided.
- The effect of seawater is generally less severe than the effect of fresh water.

7.7.3.2 Coupon level strength qualification for sandwich structures

The following properties shall be determined (for any core material):

The shear strength and the shear modulus shall be determined by shear tests following the lines of DIN 53294 (or ASTM C273) for the core and the face layers of a design-typical sandwich laminate at normal climate 23/50 as defined in ISO 291 with a minimum of 6 specimens. The production procedure of the test specimens shall be agreed with the certification body prior to the testing.

For any core materials different from closed-cell PVC foam or end-grain balsa, also the following properties shall be determined:

The tensile strength perpendicular to the faces shall be determined according to ASTM C297 or DIN 53292.

Guidance note:

If it can be documented that the interface is stronger than the core, core properties can be used to describe the interface. For many sandwich structures made of foam core the interface is stronger than the core and interface failure is actually a failure inside the core close to the interface.

---e-n-d---of---G-u-i-d-a-n-c-e---n-o-t-e---

The behaviour of the core material under long term cyclic loads shall be determined by dynamic 4-point bending tests according to ASTM C393 with the parameters from Figure 7-1:

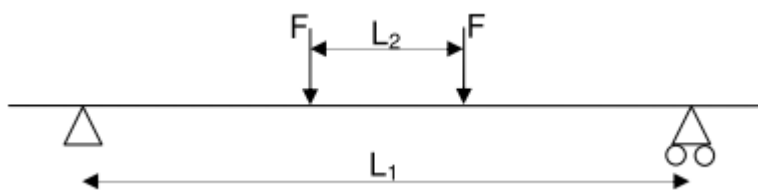

Figure 7-1 4-point loading

$L_1 = 440 \text{ mm}$ $L_2 = 82 \text{ mm}$

Preferred specimen geometry in Table 7-2:

Table 7-2 Specimen dimensions

Length L [mm]	> 550
Width B [mm]	$2 * t_{total} < B$
Core thickness t_{core} [mm]	25
Face thickness t_{face} [mm]	2 x 2.5

- The fatigue tests shall show that the core material exhibits an S-N curve slope parameter of $m \geq 10$.
- The top layer shall have a quasi-isotropic lay-up ($0^\circ / 90^\circ / +45^\circ / -45^\circ$). Other lay-ups (e.g. reflecting the actual lay-up used in the blade) can be used and shall be agreed with the certification body prior to commencing the testing.
- The combination of fabric and resin used for the face sheets shall be similar as specified for the production of the blade design the tests are intended for.
- The width of the supports and the points of load application shall at least equal the width of the specimens. Rubber pressure pads with a thickness of 3mm and a Shore A hardness of approximately 60 shall be placed between specimen and support. The supports and the points of load application shall be simply supported and the centre of rotation shall be on the neutral axis of the specimen.
- The test frequency shall be chosen in a way that no failure of the core material occurs due to heat development in the core.
- Fatigue test are performed according to ASTM C393 at $R=0.1$, $R=-1$ and $R=10$. For R-ratios of $R = -1$, and $R = 10$, careful consideration should be given to the load introduction points.

7.7.4 Adhesives

7.7.4.1 General testing information

If possible, adhesives shall have the same chemical basis as the resin compound used for the laminates to be bonded.

Guidance note:

If the bonding resin system is different from the laminating system regarding its chemical basis, the components to be bonded together shall be totally cured before the bonding process.

Adhesive and laminate type shall be compatible to ensure good bonding between adherents. Compatibility of adhesive and resin system shall be reported.

In many cases, an increase in the strength of the bonded connection can be achieved by the use of matched primers. The use of primers is particularly recommended for bonded joints which later in service are exposed to environmental influences (e.g. sea-water environment).

---e-n-d---of---G-u-i-d-a-n-c-e---n-o-t-e---

Adhesives shall not affect the materials to be bonded. They shall have a good resistance to ageing and especially the sea-water environment.

In general, bonded joints shall be durably sealed against the sea-water environment they are exposed to. If there are any un-sealed bond lines in the design of a blade, the designer shall prove by suitable long-term tests that the exposure of the bond lines to the sea-water environment does not negatively affect the strength and durability of the bonded joint during the life time of the blade.

The possibility of contact corrosion (bond-line corrosion) shall be countered by suitable means.

7.7.4.2 Coupon level strength qualification for adhesives

The following properties shall be determined (for any adhesive specified for the design):

The water absorption of the adhesive resin shall be determined according to ISO 62 (specimen 50x50x2 mm³) and shall not exceed 50mg after 168h (incl. 28d < 100mg) of immersion in water.

The adhesive resins shall show a media resistance to

- distilled water and sea water (salinity 2.5%) for exposure duration of 1000h according to ISO 175,
- water condensation for exposure duration of 720h according to ISO 6270-1,
- neutral salt spray (5% salinity) for exposure duration of 1440h according to ISO 9227.

All mechanical tests shall be performed with specimens conditioned to a saturation of 98% in seawater as well as with "dry" specimens (conditioned in normal climate 23/50 as defined in ISO 291) with minimum exposure duration of 1000h in order to determine the influence of the marine environment on the mechanical properties.

It is recommended to use a minimum of three adhesive batches for the manufacturing of the test specimens.



The following aspects shall be considered when manufacturing the test specimens for the (dynamical) mechanical testing. They shall be as equal as possible to the conditions in actual blade production:

- surface preparation of adherents
- mixing ratios, and application methods
- mating part dimensional tolerances
- bond thickness tolerances
- cure cycle
- environmental effects and ageing.

The dynamical mechanical properties (DIN EN ISO 6721-5) for the bonding material shall be determined with a starting temperature of -20°C , testing at least 3 specimens.

The shear properties of the adhesives shall be determined by lap shear tests following the lines of ISO 4587 (or ASTM D5868) for layers of a design-typical adhesively bonded laminate at normal climate 23/50 as defined in ISO 291 with a minimum of 6 specimens.

The behaviour of the adhesives under long term cyclic loads shall be determined by tests following the lines of ISO 9664. The material of the adherents shall be as design-typical as possible. The following number of specimens shall be tested with sinusoidal loading for $R=0.1$:

- 3 specimens at a load level targeting $N_1=10^4$ load cycles
- 3 specimens at a load level targeting $N_2=10^6$ load cycles
- 3 specimens at a load level targeting $N_3=10^7$ load cycles

Guidance note:

The common approach of fatigue analysis (e.g. damage accumulation according to Palmgren/Miner) is not a well-documented area for adhesive joints. Aerospace research suggests that strain rates can be critical for fatigue response; counter-intuitively adhesive bonds can sometimes fail at lower strain rates than initially expected.

---e-n-d---of---G-u-i-d-a-n-c-e---n-o-t-e---

The fatigue analysis of bonded joints may be complemented by additional aspects in order to increase its significance, e.g.:

- Fracture mechanics approach, based on limiting the strain energy release rate (G).
- Simplified shear and peel stress limits, based on demonstrated experience and/or testing.

Other tests:

- Tensile strength ISO 527
- Compression ASTM D6641
- Hardness (Shore D)
- Volumetric shrinkage ISO 3521
- Coefficient of thermal expansion DIN 53752

- Impact Strength ISO 179
- Creep test of single lap joint
- Peel test (DCB test ASTM D5528)

7.7.5 Laminated wood

7.7.5.1 Requirements for the use of wood as a structural material

The qualification of wood should be based on the same principles as the qualification of FRP materials, with the wood lamina being considered as reinforcing fibres.

Material properties as modulus and tensile and compressive strength of wood shall be corrected for effects of density. The material specification for wood shall specify an allowable range of the density.

The characteristic strength of wood shall be based on test data that are corrected to represent the worst possible moisture. The variation in moisture content of the wood used in blade production shall not exceed $\pm 2\%$.

Wood may only be used in submerged components if it is properly sealed against the surrounding sea-water environment. The sealing shall ensure that the moisture content of the wood does not increase when the component is in service.

Guidance note:

Creep and ageing of wood over the service life of a blade can normally be neglected for controlled moisture contents below 10%.

---e-n-d---of---G-u-i-d-a-n-c-e---n-o-t-e---

7.7.6 Iron castings

Iron castings shall comply with the requirements given in DNV Rules for Classification of Ships Pt. 2 Ch. 2.

7.7.6.1 Testing

For testing requirements of iron castings, see DNV Rules for Classification of Ships Pt. 2 Ch. 1 Sec. 2 and Ch. 2. Sec. 8

7.7.7 Rolled steel plates

For requirements of rolled steel plates see [7.2].

7.7.8 Surface finishing

7.7.8.1 Fillers

The use of surface fillers in order to compensate unevennesses and to build up a smooth hydrodynamic surface shall be reduced to a minimum. Accumulations of filler material shall be avoided.

Although surface fillers do not contribute to the structural strength of the blade, failure of the filler can lead to other failure modes of the parent laminate, e.g. moisture ingress and erosion, and further de-lamination of covering paint / coat.

The failure strain of any filler to be used on the blade surface shall be at least 2%. It shall be made sure that only fillers whose brittleness is not significantly increased by ageing effects, are used.



Any filler used on the surface of the blade shall be covered by a suitable coating, in order to make sure that it is sealed from the surrounding sea-water environment and that degradation of the filler by environmental influences (e.g. moisture ingress) is ruled out.

7.7.8.2 Coatings and paints

As maintenance of submerged blades is rather complex, surface coatings shall be carried out in a way leading to a minimum of required repairs during the blade's lifetime.

Due to the numerous complexities and variables in the actual environment experienced by a submerged blade as well as a lack of experience regarding the effect of these influences on the surface coating, qualification of coatings by test provides an indication for the suitability of a specific coating material only but does not guarantee durability throughout the entire design life. Ideally qualification should also be based on demonstrated previous experience by the coating manufacturer in representative conditions (i.e. other permanently submerged FRP-components).

The following aspects shall be taken into account when selecting the coating system:

- Durability of the coating system (Durability over the entire design-life shall be aimed at, if possible).
- Best possible environmental protection of the substrate (the structural component and fasteners etc. if applicable).
- A smooth surface to minimize skin friction drag and optimize power production.

The material qualification of blade surface coatings shall comprise at least the following material parameters:

- Substrate adhesion (e.g. following the lines of ISO 4624)
- Failure strain (shall be at least 2%)
- Hardness
- Long-term resistance to sea-water environment
- Resistance against erosion by sand and suspended particles/sediment
- Resistance against water erosion.

Sample substrates for qualification shall be made from representative laminates indicative of the end application; the same method of coating application as in the actual final manufacturing surface finish shall be used. Individual test methods shall follow international standards and specifications (such as ISO or ASTM).

7.7.9 Qualification of substitute materials

For the qualification of substitute materials into a design with prior certification, the above tests shall also be completed. For uncured constituent properties, the acceptance criteria for the substitute material shall take into account the manufacturing process. For the cured laminate mechanical properties, the strength values of the substitute material shall exceed that of the cured laminate being substituted for, and the modulus shall be as close as possible (in order to match the global stiffness). Where these conditions have not been met, the blade may require recertification of elements of the original design and manufacturing process.

8 DESIGN AND CONSTRUCTION OF STEEL STRUCTURES

8.1 Capacity checks

8.1.1 Ultimate limit states – general

8.1.1.1 General

The requirements for structural design given in DNV-OS-J101 apply to HATT structures with the exceptions, deviations and additional requirements specified in this section. In particular, the requirements for material factors specified in DNV-OS-J101 apply unless otherwise specified in this section.

In addition to the requirements given in DNV-OS-J101, an assessment of vibrations of the external cables shall be performed, either based on experience from similar structures or by calculations.

8.1.2 Ultimate limit states – shell structures

8.1.2.1 General

The buckling stability of shell structures may be checked according to DNV-RP-C202 or Eurocode 3/EN 1993-1-1 and EN 1993-1-6.

For interaction between shell buckling and column buckling, DNV-RP-C202 may be used.

If DNV-RP-C202 is applied, the material factor for shells shall be in accordance with Table 8-1

Table 8-1: Material factors γ_m for buckling

Type of structure	$\lambda \leq 0.5$	$0.5 < \lambda < 1.0$	$\lambda \leq 1.0$
Girder, beams, stiffeners on shells	1.10	1.10	1.10
Shells of single curvature (cylindrical shells, conical shells)	1.10	$0.80 + 0.60 \lambda$	1.40

Guidance note:

Note that the slenderness is based on the buckling mode under consideration.

λ = reduced slenderness parameter

$$= \sqrt{\frac{f_y}{\sigma_e}}$$

f_y = specified minimum yield stress

σ_e = elastic buckling stress for the buckling mode under consideration

---e-n-d---of---G-u-i-d-a-n-c-e---n-o-t-e---

In cases where recommendations for buckling checks are not explicitly given herein the analysis may be carried out by finite element analysis provided that the following effects are accounted for:

- Imperfections
- Material non-linearities
- Residual stresses
- Possible interaction between local and global buckling.

Mesh sensitivity analysis shall be carried out. The analysis methodology including calibration factors shall be checked against known design cases according to this document.

For the design of the nacelle of the HATT, reference is made to Section 10 of this standard.

8.1.3 Ultimate limit states – tubular members, tubular joints and conical transitions

8.1.3.1 General

Tubular members shall be checked according to recognised standards. Standards for the strength of tubular members typically have limitations with respect to the D/t ratio and to the effect of hydrostatic pressure. The following standards are relevant for checking tubular member strength: Classification Notes 30.1 Sec.2 (Compact cross sections), Eurocode 3 EN 1993-1-1 and EN 1993-1-6, ISO 19902 (D/t < 120) or NORSOK N-004 (D/t < 120). For interaction between local shell buckling and column buckling and for effect of external pressure, DNV-RP-C202 may be used.

Guidance note:

Compact tubular cross section is in this context defined as when the diameter (D) to thickness (t) ratio satisfies the following criterion:

$$\frac{D}{t} \leq 0.5 \sqrt{\frac{E}{f_y}}$$

E = modulus of elasticity and
f_y = minimum yield strength

---e-n-d---of---G-u-i-d-a-n-c-e---n-o-t-e---

Tubular members with external pressure, tubular joints and conical transitions may be checked according NORSOK N-004.

The material factor γ_m for tubular structures is 1.10.

For global buckling of monopiles, the material factor γ_m shall be 1.2 as a minimum.

The parametric formulas for shell buckling in EN 1993-1-6, based on membrane theory and applicable to tubular steel towers with D/t < 250, include a bias that may be accounted for by reducing the material factor γ_m for buckling to 1.1, when these formulas are used for assessment of global buckling.

8.1.4 Ultimate limit states – non-tubular beams, columns and frames

8.1.4.1 General

The design of members shall take into account the possible limits on the resistance of the cross section due to local buckling.

Buckling checks may be performed according to Classification Notes 30.1.

Capacity checks may be performed according to recognised standards such as EN 1993-1-1 or AISC LRFD Manual of Steel Construction.

The material factors according to Table 8-2 shall be used if EN 1993-1-1 is used for calculation of structural resistance

Table 8-2 Material factors used with EN 1993-1-1

Type of calculation	Material factor ¹⁾	Value
Resistance of Class 1, 2 or 3 cross sections	γ_{m0}	1.10
Resistance of Class 4 cross sections	γ_{m0}	1.10
Resistance of members to buckling	γ_{m0}	1.10

¹⁾ Symbols according to EN 1993-1-1.

8.1.5 Ultimate limit states – special provisions for plating, stiffeners and girders

8.1.5.1 General

For minimum requirements for plate thickness, stiffener sectional modulus and girders, reference is made to DNV-OS-J101 Sec. 7.5.

Buckling of stiffened plates and girders shall be checked according to DNV-RP-C201.

8.1.6 Serviceability limit states

8.1.6.1 General

Serviceability limit states for offshore steel structures are associated with:

- deflections which may prevent the intended operation of equipment
- deflections that may alter the effect of the acting forces
- deformations that may change the distribution of loads between supported rigid objects and the supporting structure
- deflections which may be detrimental to finishes or non-structural elements
- vibrations which may cause discomfort to personnel
- motion that exceed the limitation of equipment
- deformations and deflections which may spoil the aesthetic appearance of the structure.

Requirements given in DNV-OS-J101 Sec. 7.9 Serviceability Limit State shall apply.

8.1.7 Fatigue limit states

8.1.7.1 General

The aim of fatigue design is to ensure that the structure has sufficient resistance against fatigue failure, i.e. that it has an adequate fatigue life. Prediction of fatigue lives is used in fatigue design to fulfil this aim. Prediction of fatigue lives can also form the basis for definition of efficient inspection programs, both during manufacturing and during the operational life of the structure.

The design fatigue life for structural components should be based on the specified service life of the structure. If a service life is not specified, 20 years should be used.

The resistance against fatigue is normally given in terms of an S-N curve. The S-N curve gives the number of cycles to failure N versus the stress range S. The S-N curve is usually based on fatigue tests in the laboratory. For interpretation of S-N curves from fatigue tests, the fatigue



failure is defined to have occurred when a fatigue crack has grown through the thickness of the structure or structural component.

Complex connections of plated structures shall be documented according to the hot spot methodology described in DNVGL-RP-0005 Sec.4.

Characteristic S-N curves for use in design against fatigue failure are given in DNV-OS-J101. Reference is made to DNVGL-RP-0005 for practical details with respect to fatigue design of offshore structures.

Guidance note:

In general, the classification of structural details and their corresponding S-N curves in seawater with adequate cathodic protection and in free corrosion conditions can be taken from DNVGL-RP-0005.

The choice of the appropriate S-N curve for design depends on the structural detail's location and on the corrosion protection of the structural surface. Guidance on requirements for S-N curves and design fatigue factors is given in [8.1.7.4].

Curves specified for material in air are valid for details which are located above the splash zone. The "in air" curves may also be used for the internal structures of air-filled members below water.

The basis for the use of the S-N curves in DNVGL-RP-0005 is that a high fabrication quality of the details is present, i.e. welding and NDT shall be in accordance with Inspection Category I and Structural Category 'Special' according to DNV-OS-C401.

---e-n-d---of---G-u-i-d-a-n-c-e---n-o-t-e---

For qualification of new S-N data to be used in a project it is important that the test specimens are representative for the actual fabrication and construction. This includes possibility for relevant production defects as well as fabrication tolerances. The sensitivity to defects may also be assessed by fracture mechanics. Guidance on the qualification of new S-N data is given in DNV GL-RP-0005, Section 2.4.14, and associated commentary Section D.7.

Corrosion shall be taken into consideration where relevant. Both the corrosion diminution and the effect of the corrosion on the S-N curve shall be considered. Depending on the corrosion protection over the service life, different strategies for fatigue analyses are relevant.

- The structure is protected against corrosion for the whole service life: no reduction in thickness and no change in S-N curve
- The steel is coated with high quality coating: change in S-N curve at the end of the effective coating life to "free corrosion" may be needed
- No coating and without effective cathodic protection: fatigue calculations can be based on a steel wall thickness equal to the nominal thickness reduced by half the corrosion allowance over the structure's life under these conditions. S-N curves for free corrosion shall be used over this period.

For primary steel structures in the splash zone, which is defined in Section 13, the corrosion allowance can be calculated from the corrosion rates specified in DNV-OS-J101 Sec.11.

The additional costs of corrosion allowance for replaceable secondary structures should be balanced against the costs of replacement.



Calculation of the fatigue life may be based on a fracture mechanics design analysis, either separately or as a supplement to an S-N fatigue calculation, see DNVGL-RP-0005. An alternative method for fracture mechanics analysis can be found in BS 7910.

8.1.7.2 Characteristic stress range distribution

A characteristic long-term stress range distribution shall be established for the structure or structural component.

All significant stress ranges, which contribute to fatigue damage in the structure, shall be considered.

Guidance note:

Guidance on the loads to account for is given in Section 5.

Guidance on the wave theory to apply is given in Section 4.

---e-n-d---of---G-u-i-d-a-n-c-e---n-o-t-e---

Stress ranges caused by current loading shall include the low frequency cycles due to the change of current direction between ebb and flood. The damage resulting from the combination of stress ranges operating at different frequencies shall be estimated according to DNVGL-RP-0005, 0.

Whenever appropriate, all stress ranges of the long-term stress range distribution shall be multiplied by a stress concentration factor (SCF). The SCF depends on the structural local and global geometry and SCFs can be calculated based on information in relevant literature or by finite element analysis.

Guidance note:

In HATT arrays, where the same joint or structural detail is repeated many times in many identical support structures, requirements for cost-effectiveness make it particularly important to assess the SCFs accurately, and assessment by finite element analysis is recommended.

Relevant stress concentration factors can be found in DNVGL-RP-0005 and DNV Classification Notes No. 30.7. DNVGL-RP-0005 guidance is particularly relevant when parametric equations are used to calculate SCFs for tubular joints where Efthymiou equations should be applied. DNVGL-RP-0005 also provides guidance for calculation of SCFs for plated structures, particular butt welds between members with equal thickness (Sec.3.3.7.2), butt welds at thickness transitions (Sec.3.3.7.3) and conical transitions (Sec.3.3.9).

It is recommended that fabrication tolerances in accordance with "Special" category in DNV-OS-C401 are used to minimize the stress concentration factor for butt welds.

---e-n-d---of---G-u-i-d-a-n-c-e---n-o-t-e---

For fatigue analysis of both base material and welded structures not significantly affected by residual stresses due to welding, the stress ranges may be reduced prior to the fatigue analysis depending on whether the mean stress is a tensile or compressive stress. For details regarding calculation of the acceptable stress range reductions as a function of the mean stress, reference is made to DNV-OS-J101 Sec. 7.10.3.4. For stress reductions in regions of welded structural details subjected to post weld treatment reference is made to Sec.7.10.3.5 of DNV-OS-J101.

8.1.7.3 Characteristic and design cumulative damage

Predictions of fatigue life may be based on calculations of cumulative fatigue damage under the assumption of linearly cumulative damage. The characteristic stress range history to be used for this purpose can be based on rain-flow counting of stress cycles. The corresponding characteristic cumulative damage caused by this stress range history is denoted D_C .

Guidance note:

When Miner's sum is used for prediction of linearly cumulative damage, the characteristic cumulative damage D_C is calculated as:

$$D_C = \sum_{i=1}^I \frac{n_{C,i}}{N_{C,i}}$$

In which

- D_C = characteristic cumulative damage
- I = number of stress range blocks in a sufficiently fine, chosen discretisation of the stress range axis
- $n_{C,i}$ = number of stress cycles in the i^{th} stress block, interpreted from the characteristic long-term distribution of stress ranges, e.g. obtained by rain-flow counting
- $N_{C,i}$ = number of cycles to failure at the stress range $\Delta\sigma_i$ of the i^{th} stress block, interpreted from the characteristic S-N curve

---e-n-d---of---G-u-i-d-a-n-c-e---n-o-t-e---

The design cumulative damage D_D is obtained by multiplying the characteristic cumulative damage D_C by the design fatigue factor DFF.

$$D_D = \text{DFF} * D_C$$

8.1.7.4 Design fatigue factors

Requirements for the design fatigue factors (DFF) are given in Table 8-3 and depend on the risk associated to the component and on its accessibility and reparability. The design fatigue factors specified for structural details which are accessible for inspection are given with the prerequisite that inspections are carried out at intervals of four to five years.

Guidance note:

Non-accessible and non-repairable structural details will have to be designed separately from accessible and repairable details. By proper planning, it may be possible to design underwater hulls in such a manner that critical welds are located on the inside of the hull and within access.

---e-n-d---of---G-u-i-d-a-n-c-e---n-o-t-e---

The risk associated to a given component is defined in Section 1. When evaluating the risk associated to a component, impacts at various levels shall be taken into account, including

- Risk to human life
- Risk to the environment
- Risk to the operations
- Risk to the assets

An element is considered accessible if it is planned to be inspected as part of the maintenance plan. It is then considered repairable if the maintenance plan includes a possibility for reparation during the same maintenance interval.

Table 8-3 Requirements for design fatigue factors, DFF

<i>Structural element</i>		<i>Risk</i>		
<i>accessible</i>	<i>repairable</i>	<i>Low</i>	<i>Medium</i>	<i>High</i>
✓	✓	1	2	3
✓	✗	2	3	6
✗	✗	3	6	10

The design criterion is

$$D_D \leq 1.0$$

For fatigue performance of welds in tubular joints by grinding reference is made to DNV-OS-J101 Sec.7.10.7.

Guidance note:

If welds are ground in order to increase the fatigue life, the nominal stress level will increase for the same calculated fatigue life. Possible fatigue cracks will therefore grow faster after the crack has initiated.

The consequences of corrosion in the weld lines will also be larger in case of grinding. The S-N curve should be downgraded by one class as defined in DNVGL-RP-0005 and an S-N curve for free corrosion should be applied.

These two cases will both necessitate shorter time between inspections in order to keep the same risk level as for structures for which grinding is not performed.

The designer is advised to improve the details locally by other means than grinding, or to reduce the stress range through design keeping the possibility of fatigue life improvement as a reserve to allow for possible increase in fatigue loading during the design and fabrication process.

---e-n-d---of---G-u-i-d-a-n-c-e---n-o-t-e---

8.2 Connections

8.2.1 General

This section gives additional requirements for steel structure connections.

Steel structure connections shall comply with the requirements given in [8.1].

8.2.2 Bolted connections

8.2.2.1 Assessment documents

The minimum documentation to be submitted for the assessment of bolted connection is described in GL Guideline for the certification of Offshore Wind Turbines 2012 Ch. 6.

8.2.2.2 Strength analyses of bolted connections

For the strength analysis of bolted connections, reference is made to GL Guideline for the certification of Offshore Wind Turbines 2012 Ch. 6.

8.2.2.3 Slip resistant bolt connections

A high-strength bolt is defined as a bolt that has an ultimate tensile strength larger than 800N/mm² and a yield strength which as a minimum is 80% of the ultimate tensile strength.



The bolt shall be pre-tensioned in accordance with international recognised standards. Procedures for measurement and maintenance of the bolt tension shall be established.

Slip-resistant bolt connections shall be designed according to DNV-OS-J101 Sec. 7.

8.2.2.4 Ring flange connections

For the design of ring flange connections, reference is made to GL Guideline for the certification of Offshore Wind Turbines 2012 Ch. 6.

8.2.2.5 Inspection of bolted connections

All bolted connections which rely on a defined preload level and were tightened using a torque-controlled or tensioning-force-controlled method shall be retightened at least once after the commissioning (within 6 months but not directly after the installation). The original tightening torque or the original tensioning force on the bolts should be applied. The retightening time shall be specified.

An interval for regular visual inspections and looseness checks during the life cycle of the HATT shall be specified. The intention of looseness checks is to detect whether bolts have failed or have not been tightened

In the case of bolted connections which were tightened by other methods or which were brought into the plastic zone when tensioned, special inspection procedures shall be defined for each individual case.

Where the requirements above of this section cannot be followed, the use of torque-controlled or tensioning-force-controlled bolted connection shall be avoided, unless it can be shown that the effects of the relaxation have been considered and mitigated in the design.

8.2.3 Grouted connections

8.2.3.1 General

Grouted tubular connections are structural connections consisting of two concentric tubular sections where the annulus between the outer and inner tubular has been filled with grout. Grouted conical connections are structural connections which consist of two concentric conical sections where the conical-shaped space between the two cones has been filled with grout. Typical grouted connections used in offshore support structures consist of pile-to-sleeve or pipe-to-structure grouted connections, single- or double-skin grouted tubular joints, and grout-filled tubes.

Grouted tubular and conical connections, with and without shear keys, found in monopile structures for support of tidal turbine shall comply with the requirements given in DNV-OS-J101 Sec. 9. Reference is also made to DNV-OS-J101 Sec.9 for the design of tubular grouted connections with and without shear keys in jacket structures with pre- and post-installed piles.

For design of other types of grouted connections, reference is made to DNV-OS-C502 Sec. 6 and 7.

8.3 Foundation

8.3.1 General

The requirements in this section apply to pile foundations, gravity type foundations, and stability of sea bottom.

Foundation types not specifically covered by this standard shall be specially considered.



Design of foundations shall be based on site-specific information, see Section 4.

The geotechnical design of foundations shall consider both the strength and the deformations of the foundation structure and of the foundation soils. This section states requirements for

- foundation soils
- soil reactions upon the foundation structure
- soil-structure interaction.

Requirements for the foundation structure itself are given in the previous sections of this Section, as relevant for a foundation structure constructed from steel.

A foundation failure mode is defined as the mode in which the foundation reaches any of its limit states. Examples of such failure modes are

- bearing failure
- sliding
- overturning
- pile pull-out
- large settlements or displacements.

The definition of limit state categories as given in Section 2 is valid for foundation design with the exception that failure due to effect of cyclic loading is treated as an ultimate limit state (ULS), alternatively as an accidental limit state (ALS), using partial load and material factors as defined for these limit state categories. The load factors are in this case to be applied to all cyclic loads in the design load history. Lower load factors than prescribed in Section 6 may be accepted if the total safety level can be demonstrated to be within acceptable limits.

The load factors to be used for design related to the different categories of limit states are given in Section 6.

Requirements and material factors given in DNV-OS-J101 Sec.10 shall apply. This includes requirements on soil investigation and properties, and on stability of seabed.

9 DESIGN AND CONSTRUCTION OF BLADES

9.1 Design principles

9.1.1 General

Generally composite materials are used for construction of tidal turbine blades; requirements for design and construction of composite blades are given in [9.1] through [9.6].

For the case of tidal blades made of metallic materials like iron castings or rolled steel plates shall be analysed for the failure modes described in [8.1], with the addition to check for creep at low temperature on iron castings.

Design and construction of blades made of iron castings shall comply with the requirements given in [8.1], in DNV Rules for Classification of Ships Pt. 2 Ch. 2. and sections below as appropriate.

For the case of rolled steel blades, the increased complexity in design and construction shall be addressed by the risk based approach defined in [1.10].

9.1.1.1 Quality system requirements

The design manual of the blade designer shall specify details of the design processes which are covered in this section when the emphasis is on the specific materials, structural lay-out and processes relevant for the actual designs.

A specific qualification scheme shall be included for engineers who perform or supervise FEA. For FEA or analytical methods, those shall be clearly described and explained.

9.1.2 Analysis methodology

9.1.2.1 General principles

Analytical and/or numerical calculations may be used in the structural analysis. The FEA method is presently the most commonly used numerical method for structural analysis, but other methods, such as finite difference or finite series methods may also be applied.

Laminate analysis is an additional type of analysis that is applied to layered composites in order to derive the properties of a laminate from the properties of its constituent plies.

The structural analysis should be performed for all phases over the entire lifetime of the structure. Initial and degraded material properties should be considered if relevant.

A decision to use 2-D or 3-D analysis methods should generally be made depending on the level of significance of the through thickness stresses. If these stresses can be neglected, in-plane 2-D analysis may be applied. Additionally, the analysis of certain laminate and sandwich structures may be simplified by a through thickness (cross section) 2-D approach, in which plane strain condition is assumed to prevail.

Guidance note:

In-plane 2-D analysis is generally preferred when analysing relatively large and complex structures, in which through thickness stresses can be neglected. However, structural details with significant through thickness stresses, such as joints at the trailing edge, pumping effects due to buoyancy, require a more accurate analysis. In these cases 3-D or through thickness 2-D (for components possessing plane strain conditions) approaches should be applied.

9.1.2.2 Design principles

The basic approach of the Limit State Design method consists in recognising the different failure modes related to each functional requirement and associating to each mode of failure a specific limit state beyond which the structure no longer satisfies the functional requirement. Different limit states are defined, each limit state being related to the kind of failure mode and its anticipated consequences.

The design analysis consists in associating each failure mode to all the possible failure mechanisms (i.e. the mechanisms at the material level). A design equation or a failure criterion is defined for each failure mechanism, and failure becomes interpreted as synonymous to the design equation no longer being satisfied.

The partial safety factors, which are recommended in this standard, have been established such that acceptable and consistent reliability levels are achieved over a wide range of structure configurations and applications, see Section 6 of this doc.

The design criteria must be demonstrated as being fulfilled for all critical load cases, limit states, and failure mechanisms. The fulfilment of the design criteria can be demonstrated with the use of the Safety Reserve Factor (SRF) method. The SRF can be calculated for each load case and failure mode as follows:

$$SRF = \frac{R_k}{\gamma_m \gamma_n S_d}$$

where:

γ_f = load factor

F_k = characteristic load

S_d = local stress or strain based design load effect ($= \gamma_f F_k$)

R_k = characteristic resistance

γ_m = partial safety factor for material, also known as material factor

γ_n = consequence of failure factor (for ULS $\gamma_n = 1.0$ and for FLS $\gamma_n = 1.15$) assuming that the blades are identified as medium risk.

The design criteria is satisfied when $SRF \geq 1.0$. This design criterion is in principle applicable to both ultimate and fatigue limit state analysis.

9.1.2.3 Design limit states

The following two limit states categories shall be considered in the design of the tidal turbine blade:

- Ultimate limit state (ULS): The *ultimate limit state* shall be related to modes of failure for which safety is an issue. The ULS generally corresponds to the maximum load carrying capacity and is related to structural failure modes. The ULS is not reversible.
- Fatigue limit state (FLS): The *fatigue limit state* is related to failure modes linked to failure due to repetitive loads. An evaluation of the strength, detail design, and manufacturing processes must demonstrate that the failure due to fatigue will be avoided throughout the service life of the tidal turbine.

All failure modes evaluated during the static analysis should be evaluated for potential fatigue failure, with the identification of critical elements and locations along the blade where fatigue failure could occur. These locations normally include details that cause stress concentrations or at load introduction and transfer points.



The material stiffness degradation due to cyclic loading is also to be evaluated.

All ULS and FLS verifications shall be done using design loads.

9.1.2.4 Failure modes on composite blades

Composite structure fail in a complex fashion compared to isotropic materials. Composite blades shall be analysed for the following failure modes, as applicable:

- Fibre dominated failure
- Matrix dominated cracking (Inter-fibre failure)
- Delamination / Debonding
- Adhesive bonded joints failure
- Buckling failure
- Erosion of blade coating
- Sandwich failure modes
- Fatigue failure
- Creep failure
- Impact damage / failure
- Excessive deflection due to stiffness degradation
- Plastic deformation, where applicable
- Bolt failure at root joint
- Water uptake / permeability for flooded blades
- Corrosion for steel inserts and bolts at blade root joint

Further details of failure mechanisms are given in [9.2].

9.1.2.5 Safety level

The safety level is associated to the probability and consequence of failure classes, see [2.1.2]. For tidal turbine blades, the target safety level is set to normal with an annual probability of failure of 10^{-4} .

9.1.3 Load effects

Load effects shall be determined for all phases during the life of the blade, i.e. transport, installation, operation, repair. For this purpose the load effects resulting from load cases of Table 5-4 shall be considered. Nonlinear effects in the analysis shall be considered when obtaining the local stress or strain distribution.

Hydrodynamic blade loads shall be calculated by hydro-elastic methods.

Combined flap-wise and edgewise loading shall also be examined and, if critical for the design, it shall be addressed. In general, combined loads are critical for the blade root design.

9.1.4 Fatigue load effects

For tidal blades, additional considerations due to buoyancy effects shall be considered, especially for fatigue due to pumping effect.



Vibration-induced loading shall also be evaluated if detected during hydro-elastic simulations or during prototype testing. Vibration loads might reduce the design lifetime of the blade.

Sustained loads, constant mean loads have to be addressed if deemed relevant for the design.

The load effects resulting from relevant load cases for fatigue analysis of Table 5-4 shall be considered.

9.1.5 Combining load and environment

The environment may impose indirect loads on the structure, e.g. thermal stresses or swelling due to moisture uptake. This should be considered as a load effect and should be carefully examined, e.g. due to changes in temperature from the environment resulting in dimensional changes of the body shall be taken in account. However, the environment is generally considered for its effect on the degradation of material strength or change of elastic properties.

The following aspects shall also be considered when evaluating the effect of the environment on local volume elements in a structure:

- direct exposure
- possible exposure if protective system fails
- exposure after time
- exposure after diffusion through a protective layer
- exposure after accident
- exposure after degradation of a barrier material, or any material.

9.1.6 Thermal stresses

Temperature changes may introduce a different failure mechanism. If the structure is exposed to different temperatures and resulting thermal stresses, possible changes of failure modes should be evaluated. Analytically these changes are modelled by temperature dependent material properties and by possible changes in the failure criteria that are applied, e.g. ductile brittle transition.

The general thermal strains, e_i , can be expressed as:

$$e_i = \alpha_i \Delta T$$

where α_i is the thermal expansion coefficients. Temperature is denoted by T .

Residual strains shall be calculated against the reference temperature for which α_i was determined. It is usually the curing temperature.

Accordingly, the stress-strain relations shall be modified to account for the stress free environmentally induced expansion strains as follows:

$$\{\varepsilon\} = [S]\{\sigma\} + \{e\}$$

Testing should be done for all conditions that cannot be modelled in a satisfactory way.

9.1.7 Swelling

Changes in gas or fluid absorption from the environment resulting in dimensional changes of the body shall be taken in account. The general swelling strains, e_i , can be expressed as:

$$e_i = \beta_i C$$

where β_i is the swelling expansion coefficients and C is swelling agent concentration inside the laminate.

Accordingly, the stress-strain relations shall be modified to account for the stress free environmentally induced expansion strains as follows:

$$\{\varepsilon\} = [S]\{\sigma\} + \{e\}$$

9.1.8 Impact

If impact is expected during the lifetime of the structure, the effect of impact needs to be measured experimentally or estimated numerically. The effect of the damage on the remaining strength of the structure shall be assessed and quantified.

9.1.9 Design based on large scale testing

This is an alternative to calculations. Large numbers of tests are needed to get statistical relevance. This is often not practical but needed for some blade components due to complexity, e.g. composite root joint insert. Sub-component testing of root inserts is in general conducted to determine characteristic design values (this is a common practice in the wind turbine blade industry).

The level of detail of test program shall be agreed with the certification body prior to carry the tests.

Further details regarding requirements for component and sub-component testing is given in DNV-OS-C501, Sec.10.

For full scale blade testing see Section 17.

9.2 Failure mechanisms

9.2.1 General

This section lists the fundamental failure mechanisms that can occur in a tidal blade.

The design criteria in [9.1] are linked to the failure mechanisms described below.

9.2.2 Matrix cracking

Matrix cracking is defined here as the onset of matrix cracking. The increase of the number of matrix cracks at higher stresses or strains is not covered by the matrix cracking criteria presented in this section. Matrix design criteria apply to a matrix in a ply where the deformation of the matrix is restrained by the fibres of the ply or the surrounding laminate.

Two alternative design criteria can be used: the maximum stress criterion, and the Puck criterion. Matrix failure is not to be analysed on a laminate level, it shall be checked on an individual ply/lamina level.

If a structural area can fail due to wedge shaped matrix cracks under compression loading, the Puck criterion shall be used to obtain the direction of the failure surface.

9.2.2.1 Maximum stress criterion

The maximum stress criterion should be used when the stress in one direction is dominating compared to the stresses in the other directions. In this case, the simple maximum stress criterion for a dominating stress is:

$$\sigma_{nk} < \hat{\sigma}_{nk}^{matrix}$$

where:

n = direction of the dominating stress

σ_{nk} = value of the local load effect of the structure (stress) in the direction n for the design load

$\hat{\sigma}_{nk}^{matrix}$ = design value of the stress components to matrix cracking in the direction

n = the ply coordinate system.

The stress is said to be dominating when the criterion below is satisfied:

$$\max_i \left| \frac{\sigma_{ik}}{\hat{\sigma}_{ik}^{matrix}} \right| / \sum_{n \neq i} \left| \frac{\sigma_{nk}}{\hat{\sigma}_{nk}^{matrix}} \right| \geq 10$$

In the case where this criterion is not met, then there is no dominating stress, and the simple maximum stress criterion cannot be used. The combined effect of the stress components is to be evaluated, with the maximum stress criterion for a complex stress state being given by:

$$\sqrt{\sum_n \left(\frac{\sigma_{nk}}{\hat{\sigma}_{nk}^{matrix}} \right)^2} < 1$$

Where:

n = the ply coordinate system

σ_{nk} = value of the local load effect of the structure (stress) in the direction n for the design load

$\hat{\sigma}_{nk}^{matrix}$ = design value of the stress components to matrix cracking in the direction n .

9.2.2.2 Puck's criterion

Matrix failure can also be predicted using Puck's criterion which evaluates the stress state over all possible failure surfaces.

Puck's criterion is given in DNV-DS-J102 App. E, Sec. A300.

9.2.2.3 Other methods

Other methods can also be applicable provided technical argumentation, e.g. in plane shear failure, Von Mises yield criterion, see DNV-OS-C501.

The Modulus of elasticity of a composite laminate tends to reduce under the effect of cyclic fatigue. The main reason for the modulus change is the formation and accumulation of matrix cracks during tensile fatigue loads. The matrix cracks reduce the matrix dominated axial stiffness values.

Fatigue loading will most likely cause matrix cracking even at very low loads. Resistance to matrix cracking should be checked.

Strength values for matrix cracking to be used in the failure criteria can be measured according to Section 7. Strength can be measured on UD plies or it can be back calculated from cross-ply laminates.

9.2.3 Delamination

Delamination is a separation of plies. Delaminations are debonded areas that can grow gradually, once they are initiated. In sandwich structures, delaminations can also be debonding between core materials and laminated skins.

For assessing delamination, in general a fracture mechanics approach has to be deployed. By using fracture mechanics approach, a fatigue lifetime prediction methodology can be developed for delaminate structures. For this, fracture toughness and fatigue crack growth rate data needs to be determined experimentally. This is a field that is still under development.

If delamination is a failure mechanism foreseen by design, it shall be properly addressed. If those happen when the blade is in service, then it has to be treated case by case.

For the determination of fracture properties of delaminations or debonds, there are standardized and non- standardized test methods. Those methods shall be agreed in beforehand with the certification body.

9.2.4 Fibre dominated failure

Fibre failure is defined here as the failure of a ply by fracture of fibres. The fibre strength or strain to failure is based on test results from plies or laminates as described in Section 7. Ply failures are measured as rupture of the ply in fibre direction.

The maximum strain criterion is to be used to check fibre failure. Other design criteria may be used if it can be demonstrated that they are equivalent to or conservative relative to the maximum strain criterion given here.

If laminates have a lay-up with fibre orientation seen through the entire thickness that are more than 45° apart, matrix cracking or deformation due to in plane ply shear stresses may cause rupture of the laminate. In this case matrix cracking due to ply shear should also be checked to avoid fracture, burst or leakage; unless it can be shown that matrix cracks or deformations can be tolerated by the laminate under the relevant loading conditions.

If laminates have a lay-up with fibre orientation seen through the entire thickness that are more than 70° apart, matrix cracking or deformation due to in plane ply shear stresses or stresses transverse to the fibres may cause rupture of the laminate. In this case matrix cracking due to all possible stress components should also be checked to avoid fracture, burst or leakage, unless it can be shown that matrix cracks or deformations can be tolerated in by the laminate under the relevant loading conditions.

Fibre failure is to be checked at the individual ply level, not at the laminate level. Regardless of the analysis method used, analysis is to be conducted with non-degraded matrix dominated elastic constants, i.e., E_{11} , E_{22} , G_{12} , ν_{12} .

9.2.4.1 Maximum strain criterion

For single loads the maximum strain design criterion is given as:

$$\varepsilon_{nk} < \hat{\varepsilon}_{nk}^{fibre}$$

ε_{nk} = Strain response in the fibre direction at the design load

$\hat{\varepsilon}_{nk}^{fibre}$ = Design value of the axial strain to fibre failure

Other failure criteria such us Tsai-Hill, modified Tsai-Wu can be used; further information can be found in DNV-DS-J102 and DNV-OS-C501.

Strength values for fibre failure to be used in the failure criteria can be measured according to Section 7 (based on testing), ply properties or back calculation.

Compressive strength will also depend on matrix properties.

9.2.5 Laminate failure

Laminate failure can be predicted using Puck's criterion which evaluates the stress state over all possible failure surfaces, see [9.2.2.2].

9.2.6 Permeability

If the blade has flotation, permeability should be checked.

9.2.7 Maximum deflection

The deflection of the blade shall be kept smaller than a specified upper limit in order to avoid blade contact with the tower or other components.

9.2.8 Modal behaviour of the blade

Resonance should be avoided based on natural frequency calculations.

In air natural frequencies shall be identified. Some analysis shall be performed to derive in-water natural frequencies.

In-water natural frequency can be estimated as follows

$$\omega_{n_{wet}} = \frac{m}{m + m_a} \omega_{n_{air}}$$

With:

m the overall mass of the blade

m_a the added mass of the blade for the considered degree of freedom

$\omega_{n_{air}}$ the in-air radian frequency

Where the blade can be divided in sections within which geometrical parameters can be considered as constant, the blade added mass can be approximated as follows:

Flap-wise added mass

$$m_{a_f} = \sum_{i=1}^n \rho \pi l_i \left(\frac{a_i}{2}\right)^2$$

Edgewise added mass

$$m_{a_e} = \sum_{i=1}^n \rho \pi l_i \left(\frac{b_i}{2}\right)^2$$

Torsional added mass

$$m_{a_t} = \sum_{i=1}^n \rho \pi \left[\left(\frac{a_i}{2}\right)^2 - \left(\frac{b_i}{2}\right)^2 \right]^2$$

With:

l_i the length of the i^{th} segment

a_i the blade chord at the i^{th} segment

b_i the blade thickness at the i^{th} segment

ρ the water density

The drag coefficient and added mass may also be derived from CFD analysis.

9.2.9 Creep and stress relaxation (in water)

Creep modulus measurements may be used to estimate modulus changes under permanent deformation.

Stress relaxation is a phenomenon mainly observed in the matrix. However, fibres may show some stress relaxation behaviour as well.

The application of a permanent deformation may lead to stress relaxation. This is described as a reduction of the Modulus of elasticity. The result of the reduction of the Modulus of elasticity is a reduction of stress in the structure under the constant deformation.

Ideally stress relaxation should be measured on the actual laminate for the relevant loading condition.

For fibre dominated elastic constants stress relaxation data of the same fibre type may be used to estimate the change of the modulus. Stress relaxation shall be measured for the combination of matrix and fibres.

For short fibre composites all elastic constants shall be considered to be matrix dominated with respect to stress relaxation.

For matrix dominated elastic constants stress relaxation data of the matrix alone shall not be used to estimate the change of the modulus.

Tensile stress relaxation data may be used to estimate stress relaxation in compression.

Compressive stress relaxation data shall not be used to estimate stress relaxation in tension.

When the blade is subjected to constant loading, permanent static deformations may be seen and may have the following effects:

- Stress relaxation: a visco-elastic or plastic process reducing the stresses in the material. This effect is accompanied by a reduction of the elastic modulus.
- Residual strength reduction: the static short-term strength may be reduced.

9.2.10 Impact

Impact from foreign objects can cause a local or global damage depending on the extent of impact. Accidental impacts (e.g., during transport and servicing) are also to be considered.

The application of high loading rates, impact, may cause the core or the adhesive material to behave differently.

Strain rate effects are material-dependant but also vary with temperature.

Typical apparent effects of high loading rates are:

- increase in strength
- increase in modulus
- decrease of strain to failure
- change of failure mode from ductile or plastic to brittle.

Decrease of strain to failure under high strain rate regime may be critical at stress concentration areas, for example, area of load introduction, joints, inserts.



When strain rates effects are unknown, strength and elasticity modulus for quasi-static conditions should be used together with strain to failure at high strain rate - as a conservative approach.

Increase of strength due to strain rate increase shall be quantified.

9.2.11 Wear

Wear is the loss of material from a solid surface as a result of pressure sliding exerted by one body on another. Wear properties are not material properties but are very dependent on the system in which the surfaces function:

- the two surfaces in contact (basic part and counterpart)
- the applied loads
- the external environment
- the interlayer environment.

For tidal blades, wear may be seen as erosion, see [9.3.7].

9.2.12 Chemical and water degradation

For the effects of chemical and water degradation mechanisms reference is made to DNV-OS-C501.

9.2.13 UV exposure

UV radiation can break down the polymers and reduce their strength. The resistance of surface layers to UV radiation shall be documented and quantified if necessary.

Glass and carbon fibres are very resistant to UV radiation and thus they do not require protection. Aramid fibres are not resistant to UV radiation and shall be protected. Polyesters tend to have a good UV resistance. Epoxies tend to have a bad UV resistance. Vinylesters tend to have a variable UV resistance.

All insulating surface finishing products shall be designed to insulate the FRP material from the environment for the service life of the tidal turbine.

Materials shall be selected that do not decompose chemically in the expected environment during the design lifetime. If this cannot be avoided, these effects shall be quantified and allowed for in the development of the material's characteristic strength. An alternative is to define periodic inspection intervals.

9.2.14 Core failure (sandwich)

Sandwich structures are generally constructed of a light weight core embedded between two faces or skins.

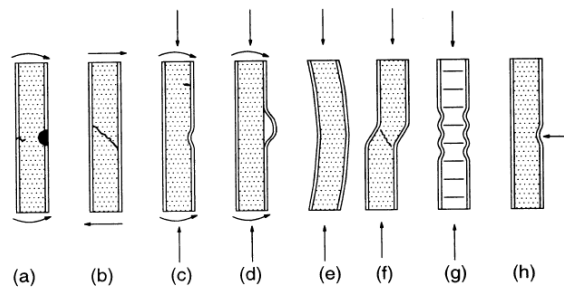

- | | |
|-----------------------------|-----------------------------|
| (a) face/core failure | (e) general buckling |
| (b) core shear | (f) shear crimping buckling |
| (c) face wrinkling buckling | (g) face dimpling buckling |
| (d) de-lamination | (h) core indentation |

Figure 9-1 Typical sandwich failure mechanisms

Further information on the above mentioned failure modes are described in DNV-DS-J102, App. G.

9.2.15 Fatigue

Fatigue failure mechanisms are given in DNV-OS-C501 Sec. 6.

9.2.16 Stress rupture

The time to failure under a permanent static stress is described by a stress rupture curve determined experimentally.

Ideally stress rupture shall be measured on the actual laminate for the relevant loading condition and environment.

For fibre dominated strength values stress rupture data of the same fibre type may be used to estimate stress rupture.

For short fibre composites stress rupture of the matrix due to shear in the matrix shall be considered in addition to stress rupture of the fibres.

For matrix dominated strengths, stress rupture data of the matrix alone shall not be used to estimate stress rupture. Stress rupture shall be measured for the combination of matrix and fibres.

Tensile stress rupture data may be used to estimate stress rupture in compression.

Compressive stress rupture data shall not be used to estimate stress rupture in tension.

9.2.17 Adhesive bonding failure

Adhesive bonding failure is addressed in [9.4.2].

9.2.18 Polymer failure

If the blade has watertight compartments they may have a polymer liner which is going to create an interface that needs to be addressed.

Fluids may accumulate between interfaces. They may accumulate in voids or debonded areas and/or break the bond of the interface. The effect of such fluids should be analysed. Possible rapid decompression of gases should be considered.

Liners that do not carry any structural loads shall have a high enough strain to failure or yield that they can follow all possible movements of the interface. Yielding of liners should be avoided,



since yielding can cause local thinning or introduce permanent stresses after yield. If yielding cannot be avoided it shall be analysed carefully. The effect of local yielding on the surrounding structure shall also be considered.

9.3 Design requirements for main blade

9.3.1 Rupture

Fibre dominated failure shall always be considered as causing rupture.

9.3.2 Buckling

9.3.2.1 Concepts and definition

Buckling of the blade and its components is mainly considered as a ULS failure mode. Fatigue buckling shall not occur at any section of the blade.

Elastic buckling phenomena are commonly considered in two main categories:

- *Bifurcation buckling*: Increasing the applied loading induces at first deformations that are entirely (or predominantly) axial or in-plane deformations. At a critical value of applied load (elastic critical load) a new mode of deformation involving bending is initiated. This may develop in an unstable, uncontrolled fashion without further increase of load (unstable post-buckling behaviour, brittle type of failure), or grow to large values with little or no increase of load (neutral post-buckling behaviour, plastic type of failure) or develop gradually in a stable manner as the load is increased further (stable post-buckling behaviour, ductile type of failure).
- *Limit point buckling*: As the applied load is increased the structure becomes less stiff until the relationship between load and deflection reaches a smooth maximum (elastic critical load) at which the deformations increase in an uncontrolled way (brittle type of failure).

Guidance Note:

It is important to mention that buckling response is highly dependent on the tools employed for performing the analysis, and in general, this is verified by testing, either sub-component or full scale testing.

---e-n-d---of---G-u-i-d-a-n-c-e---n-o-t-e---

Determination of the elastic critical load of a structure or member that experiences bifurcation buckling corresponds to the solution of an 'eigenvalue' problem in which the elastic buckling load is an 'eigenvalue' and the corresponding mode of buckling deformation is described by the corresponding 'eigenvector'.

Elastic buckling may occur at different levels:

- *global level for the structure*; this involves deformation of the structure as a whole.
- *global level for a structural member*; this is confined mainly to one structural member or element but involves the whole of that member or element.
- *local level for a structural member*; only a part of a structural member or element is involved (e.g. local buckling of the flange of an I-beam or of a plate zone between stiffeners in a stiffened plate).



Initial geometrical imperfections (out-of-straightness, out-of-roundness, or eccentricity of applied loading) that lead to a situation where compressive forces in a structural part are not coincident with the neutral axis of that part may influence significantly the buckling behaviour. An idealised structure without such imperfections is referred to as “geometrically perfect”.

Bifurcation buckling is essentially a feature of geometrically perfect structures. Geometrical imperfections generally destroy the bifurcation and lead to a situation where bending deformations begin to grow as the applied load is increased. An elastic critical load may still be associated with the structure, and may provide a good indication of the load level at which these deformations become large. However, some structures with unstable post-buckling behaviour are highly sensitive to geometric imperfections. In the presence of imperfections these structures may experience limit point buckling at loads significantly lower than the elastic critical load of the geometrically perfect structure.

Elastic buckling deformation of a geometrically perfect or imperfect structure may trigger other failure modes in FRP materials such as fibre failure (compressive or tensile), and matrix cracking. The presence of damage such as matrix cracking, or de-lamination may also significantly influence the buckling behaviour of structures and structural members.

9.3.2.2 Calculation of buckling resistance

The blade shall be analysed for buckling and the buckling resistance calculated according to the procedure defined in DNV-DS-J102 App. C, Sec. A300.

9.3.2.3 Buckling analysis of individual components

Reference is made to DNV-DS-J102 App. C, Sec. A400

9.3.2.4 Buckling analysis of more complex elements or entire structures

Reference is made to DNV-DS-J102 App. C, Sec. A500

9.3.3 Deflections

All permissible failure mechanisms shall be included in the calculations, such as matrix cracking and delamination.

Softening of material properties due to water shall be included.

The deflection of the blade shall be kept smaller than a specified upper limit given by the SLS in any load case from Table 5-4, in order to avoid blade contact with the support structure or other components.

The maximum allowable blade deflection shall account for

- marine growth
- yawing angle of the turbine, including possible incertitude
- any suction effect resulting from the interaction between the blade and the support structure, or other obstacle.

The deflection analysis is to model representative stiffness of the HATT, and therefore is to include the stiffness of the hub, pitch bearing, and other associated components.

The material factor in deflection criteria (mainly tip to support structure distance) shall be taken as 1.1 when mean values for stiffness are used in the analysis. The material factor may be reduced to 1.0 if:

- The deflection analysis is carefully calibrated with the full scale static testing of the blade
- A quality control instruction covers retesting of the flap wise stiffness for manufactured blades on a spot check basis or other measures taken to assure that the stiffness of all blades manufactured conform accurately to that of the test blade.

9.3.4 Torsion

If torsion shall be limited, this needs to be checked. Some laminate configurations or lay-ups may be sensitive to matrix cracking due to torsion, if this is the case, this has to be analysed by a criterion valid for matrix cracking, see [9.2.2].

In any case torsional strength needs to be evaluated.

9.3.5 Fluid tightness

If parts of the blade should be fluid tight, the tightness should be demonstrated by hydrostatic pressure tests, i.e. to 150% of the designed working pressure. The test, in general, involves filling pressurised system with a liquid, usually water, which may be dyed to aid in visual leak detection, and pressurization of the pressurised system to the specified test pressure, i.e. 150%.

Fluid tightness means here that water cannot come in. It may also mean that the internal gas (air etc.) cannot get out. This would be especially important for pressurized systems.

In some cases the blade may also work when it becomes flooded. In that case demonstration of fluid tightness may be less critical.

The barrier systems shall be identified.

Note that an accumulation of matrix cracks and delamination may lead to a loss of fluid tightness.

In a simplified way initiation of matrix cracking may be used as loss of fluid tightness. However, this tends to be overly conservative.

9.3.6 Max change of profile shape

If dimensional tolerances for the hydrodynamic profile are specified, it shall be shown that these tolerances remain within acceptable tolerances over the lifetime. A significant change in the hydrodynamic shape might have an impact on the turbine loads.

9.3.7 Erosion

Erosion is defined as the loss of blade coating material that results in a fast deterioration of the performance of the component, especially if unprotected laminate is exposed to sea water.

Sand etc. going over the blade. Erosion is a complex problem and there are no coating systems capable to provide 20 years (to take the wind industry as example) of lifetime.

Wear resistance coatings may be required to ensure or increase the component lifetime.

In general, periodic inspection intervals are recommended in order to prevent extensive erosion. Monitoring system can also help detecting coating failure due to erosion.

Mechanical properties of the coating material shall be specified, including application method and allowed thickness.



There may other contributing factors to erosion of tidal blades, e.g. sediments, silt, sand, etc. The impact of these factors shall be assessed and, if possible, quantified. If this is not possible, a local reinforcement or additional protection shall be implemented.

9.3.8 Cavitation

Cavitation occurs when the pressure – mainly on the suction side of a profile is below the vapour pressure of the fluid. Cavitation can occur in different forms, e.g. tip vortex cavitation, sheet cavitation or bubble cavitation. Cavitation can cause significant erosion on the blades and shall be avoided. Further cavitation can cause performance degradation and impose significant acoustic emissions to the environment.

Cavitation shall be avoided by proper selection of blade profiles and/or limiting rotor tip speed. An analysis should be performed either by computational means or by model tests.

For further guidance see DNV Classification Note No. 41.5 “Calculation of Marine Propellers”, GL Technical Publication “Recommendations for Rudder Design Preventive Measures to Decrease or Avoid Rudder Cavitation” and the GL Rules & Guidelines III, Part 1, Ch. 2 “Propulsion Plants”.

9.3.9 Aeration

A special case of cavitation is the aeration. In conjunction with hydrostatic and hydrodynamic pressure on the blades, the pressure at the suction side may be lower than the atmospheric pressure at the water surface. In some cases the water surface breaks down to the suction side of the surface, resulting in loss of lift and increased loading on the structure. Aeration shall be avoided in all operating conditions of the system by using of constructive measures (skirts etc.) or by enabling sufficient distance to the instantaneous water surface at its lowest limit.

9.3.10 Corrosion

When metallic bolted joints or root inserts are used appropriate design against corrosion shall be considered, see [9.4.4].

9.3.11 Marine growth

In the analysis of a tidal turbine and blade the influence of marine growth, both on structural mass and on the hydrodynamic behaviour of the structural members shall be considered.

Standard offshore engineering procedures may be used to account for these effects. Guidance for the thickness of marine growth and procedures for the analysis of the hydrodynamic coefficients is given in DNV-RP-C205 Sec. 6 and DNV-OS-J101 Sec. 4.

Serviceability and maintainability of the structure may be reduced by marine growth significantly. Regular surveying and cleaning of the structure may be necessary.

9.3.12 Impact resistance

Impact resistance shall be demonstrated by full scale or large scale testing.

The residual strength after impact shall be still sufficient to meet all other design requirements.

9.4 Design requirements for joints between blade parts

9.4.1 General

The requirements detailed in [9.3] apply for joints between blade parts.



Design of those bonded joint shall consider the following parameters, type of adhesive, bond-line interface and inter-laminar loading of the adjacent substrate material, mismatch of stiffness properties, etc.

Adhesive joints comprising dissimilar substrates, such as composite to metal interfaces, or laminates with different elastic properties, shall also be handled within this section.

All relevant failure modes applicable to bonded joint shall be evaluated including the effect of stress/strain concentrations due to geometrical discontinuities/transitions. Bonded joints along the blade may undergo different loading conditions which may imply different failures modes; as such bonded joint design shall cover all expected failure modes.

Adhesives exist on a variety of types, e.g. epoxy based, polyurethane, acrylic, polyester, etc. It is important to note that the chosen adhesive has to compatible with the blade material system. The type of adhesive and its mechanical properties have an influence on the expected failure mode. The material properties of the adhesives shall consider the following as a minimum: surface preparation of adherents, specified mixing ratios, and application methods, mating part dimensional tolerances, bond thickness tolerances, cure cycle, post bond inspection requirements, ductility, shear and peeling strength characterisation, failure modes (as described above), environmental effects and ageing. Material properties shall be determined according to Section 7.

The selected adhesive has to be suitable for the service conditions, temperature and environment.

Durability of the adhesive shall also be assessed and quantified.

Adhesive fatigue criteria should be based on one or a combination of the following approaches:

- fracture mechanics approach, based on limiting the strain energy release rate (G)
- simplified shear and peel stress limits, based on demonstrated experience and/or testing
- traditional S-N curve development, and subsequent FLS analysis.

Guidance note:

Shear tests have not traditionally provided a reliable measure of adhesive durability (including fatigue). Peel testing often proves more reliable for evaluating weak adhesive bonds.

---e-n-d---of---G-u-i-d-a-n-c-e---n-o-t-e---

For traditional FLS analysis, the development of adhesive joint S-N curves should be based on test coupons manufactured from adherents representative of the final joint's configuration. A minimum of 5 coupon test points at the relevant R-ratio is recommended to provide confidence in the S-N curve. The S-N curve is to be developed from characteristic values.

9.4.2 Failure modes

Adhesives joints exhibit complex failure modes due to complex loading and susceptibility to manufacturing defects. The following failures are considered.

9.4.2.1 Adhesive/adherent interface failure

This failure is characterized by the failure at the adhesive and the adherent interface, i.e. interface failure. If an interface failure occurs, it might be caused by poor adherent preparation



and/or incompatible adhesive, among other causes. If the design predicts interface failure, consideration regarding mixed mode loading is suggested, i.e. mix of shear and peeling stresses.

9.4.2.2 Adhesive failure

This failure is characterized by the failure at the adhesive, i.e. cohesive failure. Adhesives can have a nonlinear behaviour with large strains to failure, thus it may experience ductile failure.

9.4.2.3 Adherent failure

This failure is characterized by the failure of the adherent, i.e. the adhesive is stronger than the adherents. The failure modes are the same as for a composite laminate, matrix or fibre failure. For additional information of composite laminate failure modes, see [9.3].

9.4.3 Torsion

Torsion may introduce a tear loading of bonded joints. If deemed critical, those shall be considered during the design stage of the bonded joint. This may also be deemed relevant for UD laminates (matrix cracking) in the main load carrying component of the laminate.

9.4.4 Corrosion

For metallic components, a suitable corrosion protection method shall be described, analysed and reported, see Section 13.

For laminates, stress saturation and swelling shall be evaluated.

9.5 Design requirements for root joint

9.5.1 General

The requirements detailed in [9.3] apply for root joint.

The most severe stresses in a circular blade root section may not necessarily occur in the flap-wise and edgewise directions. The angular sector between these bending moments and the subsequent sector up to 90° shall be examined, so that a total sector of 180° is covered.

The root joint shall be analysed for ULS and FLS.

In general, sub-component testing of root joints is performed in order to determine characteristic design values. This is dependent on the complexity of the root joint, examples of root joints are steel inserts bonded to the root laminate, drilled holes for T-bushings, etc.

Depending on the degree of complexity and material used, the root joint section has to be analysed using the defined material safety factors listed in [9.6].

For steel inserts and bolts, corrosion protection shall be ensured, see Section 14. The design of metallic components and their corresponding material safety factors are given in the Section 8.

For performing the analysis of bolted joints under ULS and FLS, VDI 2230 can be used or other reliable reference. The bolted joint shall provide sufficient redundancy in case of a bolt failure.

In general, bolted joints for pitch regulated blades are exposed to more complex loading than stall regulated blades. This shall be considered in the analysis.

9.6 Partial safety factors for materials

9.6.1 General

The value of the partial safety factor for materials accounts for the inherent variability and uncertainties in composite materials and structures, i.e. FRP, structural adhesives and sandwich constructions. To account for the general variability in composite materials, the material factors must be specifically developed for each material type, combination of material constituents and manufacturing processes.

For FRP and laminated sandwich structures, the variability and environmental effects on material's strength can be significant. The variability can be accounted for either through a dedicated test program, or through an empirical approach based on Table 9-1 through Table 9-3 (for relevant material system).

For a dedicated test program, the material properties must be developed based on enough tests of material meeting recognised specifications to establish the design values on a valid statistical basis. The test program can be adopted within this document, and should take into account as a minimum the effects of:

- variability in the constituent materials
- variability in the manufacturing process
- environmental effects, such as temperature and moisture
- effects of cyclic loading
- local laminate details, such as ply drops, overlaps, fibre misalignments, dry glass, etc.

Where a dedicated test program has not been conducted, the material factor is to be calculated by an empirical approach using the partial factors listed in Table 9-1 through Table 9-3 for the corresponding limit state analysis.

9.6.2 Ultimate limit state (ULS)

The analysis can be carried out by linear analysis, if the linearized pre-buckling analysis indicates that the effect of buckling is moderate and limited to only a few elements that do not interact. If this is not the case, then a geometric nonlinear analysis shall be performed.

Inter-laminar failure, delamination or de-bond failure can occur between adjacent laminas, cores or adhesives due to out-of-plane shear stresses and out-of-plane normal stresses. These failure modes will typically appear at design details such as thickness transitions, bolt connections, adhesive bond joints etc., which should be account for. The static limit state of these failure modes can be verified by analyses, sub-structural or full-scale testing in a static setup.

Sandwich core material failure can occur due to tensile, compressive, and shear loading. This failure mode should be accounted for, as described in [9.2.14].

9.6.3 Fatigue limit state (FLS)

Fatigue failure is associated to accumulation of damage in excess of that allowed by the fatigue strength of the material. The fatigue strength parameters shall be knocked down by the applicable material safety factors listed in the forthcoming sections.

Linear damage accumulation in the fibre direction according Palmgren Miner may be used to obtain the total damage. In that case, stress or strain based constant life time diagram shall be

constructed from the available characteristic S-N curves. The characteristic number of cycles to failure shall be extracted for each applied strain condition (amplitude and mean level) from the constant lifetime diagram. The number of expected cycles to failure shall be found for the applied strain or stress.

Fatigue calculation may be based on damage equivalent loads, Markov matrices or load time series.

A particular fatigue failure mechanism may be acceptable for the blade if it can be demonstrated that progressive damage due to the failure mechanism does not otherwise compromise the structural integrity of the blade (e.g., static failure, excessive deflection, etc.) during its design life expectancy. The basic approach may be the same for all failure mechanisms; however different S-N curves and residual strength values shall be considered

9.6.4 Partial material safety factors for FRPs and Sandwich Composites

The material factor γ_m is given as a product of several factors:

$$\gamma_m = \gamma_{m1}\gamma_{m2}\gamma_{m3}\gamma_{m4}\gamma_{m5}\gamma_{m6}$$

where:

γ_{m1} to γ_{m6} are the partial safety factors and strength reduction factors described in Table 9-1.

Table 9-1 Partial safety factors for materials (γ_m) for FRPs and Sandwich Composites

Description	Factor	Limit States	
		ULS	FLS
Base material factor for materials	γ_{m1}	1.3	1.2
Material degradation factor (product of the below listed factors, the first factor is always included and it is multiplied to the relevant one)	γ_{m2}		
— Strength reduction factor for repeated loading/low cycle fatigue		1.1	1.0
— Epoxy based resin systems		1.1	1.1
— polyester, and vinyl ester based resin system		1.2	1.2
— wood with epoxy FRP shielding.		1.1	1.1
Production method factor	γ_{m3}		
— Prepreg or resin infusion unidirectional plies – areas with continuous plies and no ply drops and manufacturing methods which do not allow wrinkles through laminates		1.0	1.0
— Prepreg or resin infusion with mainly unidirectional plies including ply drops		1.1	1.1
— Random orientated mats and/or hand lay-up.		1.2	1.2
Temperature and humidity (submerged condition) factor	γ_{m4}		
— If temperature and humidity effects are measured		1.0	1.0
— If temperature and humidity effects are NOT measured but estimated.		1.1	1.1
Curing factor	γ_{m5}		
— Post-cured laminate controlled with DSC or equivalent		1.0	1.0
— Exothermic curing only		1.05	1.05
Sandwich constructions	γ_{m6}		
— Plastic polymeric foam, designed for yielding (PVC)		1.0	1.0
— Brittle polymeric foam designed for fracture (PMI)		1.1	1.1
— Balsa wood.		1.3	1.3

9.6.5 Buckling material factors

In case of buckling analysis and material safety factors, those are to be applied in the stiffness or strength of the characteristic material property.

The material factor γ_{mc} for buckling is given as a product of several factors; see Table 9-2 for numerical values:

$$\gamma_{mc} = \gamma_{mc1}\gamma_{mc2}\gamma_{mc3}$$

Table 9-2 Partial safety factors for materials for buckling

<i>Description</i>	<i>Factor</i>	<i>ULS</i>
Base material factor for materials	γ_{mc1}	1.2
Material degradation factor	γ_{mc2}	
— If degradation effects on stiffness are measured, or adequately taken into consideration		1.0
— If degradation effects are not accounted for		1.1
Model factor	γ_{mc3}	
— Non-linear FEA validated by tests		1.05
— Non-linear FEA analysis only		1.15
— Linear FEA only		1.25
— Analytical methods only		1.50

9.6.6 Inter-fibre failure analysis

Inter-fibre failure (IFF) analysis is a failure mode that may accelerate or worsen the environmental degradation due to exposure to sea water. This failure mode can be verified by testing as well. If this is the approach, the certification body shall be contacted in order to agree the level of testing.

In order to be able to identify potential IFF critical areas of the blade, it is in all cases required to analyse the blade structure with respect to IFF, i.e. matrix cracking.

9.6.7 Partial material safety factors for bonded joints

Depending of the manufacturing process of the blade, it may contain structural bonded joints. Bonded joints are strongly dependent on bond line thickness, manufacturing-induced defects, quality of surface preparation, mix ratios, etc. The design of bonded joint is a complex in the sense that involves complex failure modes. In order to overcome the complexities involved in the bonded joint design and known variability in strength properties, the characteristic strength of the material has to be lowered by the partial material safety factors given in Table 9-3. The material factor γ_{mb} for bonded joints is given as a product of several factors.

$$\gamma_{mb} = \gamma_{mb1}\gamma_{mb2}\gamma_{mb3}\gamma_{mb4}\gamma_{mb5}\gamma_{mb6}$$

Table 9-3 Partial safety factors for materials for bonded joints

Description	Factor	Limit States	
		ULS	FLS
Base material factor for materials	γ_{mb1}	1.3	1.2
Material degradation factor (product of the below listed factors, the first factor is always included and it is multiplied to the relevant one)	γ_{mb2}		
— Strength reduction factor for repeated loading/low cycle fatigue		1.1	1.0
— Epoxy based resin systems		1.1	1.1
— polyester, and vinyl ester based resin system		1.2	1.2
Production method factor	γ_{mb3}		
— if analysis is based only under in-plane shear loading		2.0	2.0
— If analysis considers effect of peeling stresses (this considers the use of fracture mechanics approach)		1.3	1.3
Temperature and humidity (submerged condition) factor	γ_{mb4}		
— If temperature and humidity effects are measured		1.0	1.0
— If temperature and humidity effects are NOT measured but estimated.		1.05	1.05
Curing factor	γ_{mb5}		
— Post-cured laminate controlled with DSC or equivalent		1.0	1.0
— Exothermic curing only		1.1	1.1
Inspection method to ensure bond thickness and width tolerances	γ_{mb6}		
— Ultrasound, shearography and/or thermography (thermo-imaging) including repair and/or refill		1.1	1.1
— Digital coin tapping, including repair and/or refill		1.2	1.2
— Coin tapping and visual, including repair and/or refill		1.3	1.3

9.6.8 Structural health monitoring of tidal blades

Structural health monitoring (SHM) can be implemented in order to monitor any damage development. The SHM shall not introduce any stress concentration in the blade. The functionality of the system shall be described including all parameters.

Examples of structural health monitoring systems are:

- implementation of fibre optics to monitor changes on strain levels, acoustic emission sensors to detect onset of cracking,
- implementation of accelerometers to monitor changes in the natural frequencies of the blade as damage indicators, etc.

If the blade and the tidal turbines are to be water-tight, humidity or water sensors can be used.

Structural health monitoring systems can also prevent catastrophic failure or assist in lifetime prediction methodologies of damaged composites structures.

10 MACHINERY SYSTEMS AND COMPONENTS

10.1 General

This section describes the strength assessment of the machinery system and components of the HATT.

The following systems and components are addressed:

- pitch
- yaw
- lubrication
- ballast
- bilge
- cooling
- heater and de-humidifying
- braking
- hydraulic.

Components:

- torque limiter
- couplings
- brake
- main gearbox
- shafts (low, high speed and others)
- main, pitch and yaw bearings
- actuators
- pitch and yaw gearbox
- seals.

For the important components, parts lists are required with data about materials, data from the manufacturer in the case of mass-produced parts, about the standard in the case of standardized parts etc.

Engineering drawings (assembly drawings and individual-part drawings) of the important elements of the HATT machinery, executed in standard form, are required; clear identification shall be assured (parts designation, drawing number with date and revision index). They shall contain data about surface finish, heat treatment, corrosion protection etc.

Strength calculations for all machinery components and their structural connections shall verify the ULS and SLS totally, clearly and confirmable. The analyses shall be complete and unified in themselves. They shall contain adequate data concerning:

- design loads
- static systems (analogous models)
- materials
- permissible stresses
- references used.

Where no specific requirements are given in this standard regarding dimensioning and choice of materials, generally recognised material standards and engineering principles may be applied.

Fatigue analysis shall be carried out in accordance with generally recognised standards and engineering principles for machinery components which have no specific requirements given in this standard, see Section 2. Fatigue damage calculation for structural components shall be

performed following the modified Palmgren-Miner approach. The application of a fatigue limit is not accepted in general. For heat treatable steels the use of a cut-off in the S-N-curve is allowed.

The strength analysis for machinery structures (e.g. hub, machine foundation) shall be based on design fatigue factor DFF (see Section 8). For machinery structures (e.g. hub, machine foundation) the partial safety factor for metallic materials shall be $\gamma_m = 1.1$ for ULS and ALS. For FLS the DFF factors according to Table 8-3 shall be applied.

For all other machinery components the partial safety factors γ_m for FLS shall be applied according to Table 10-1.

Table 10-1 Partial Safety factor γ_M for FLS

<i>Inspection and Accessibility</i>	<i>Risk</i>		
	<i>High</i>	<i>Medium</i>	<i>Low</i>
Periodic monitoring and maintenance; good accessibility	1.15	1.0	1.0
Periodic monitoring and maintenance; poor accessibility	1.25	1.15	1.0

All lubricants and hydraulic fluids shall be specified with the corresponding type sheets. Where possible spilling of these fluids to the maritime environment could not be entirely excluded by a risk based analysis, biodegradable fluids shall be used.

10.2 Pitch mechanism with bearing and actuator

This section applies for rotor blade pitching systems of HATT as described below. In the event of other designs, the wording shall apply with the necessary changes.

- Systems with rotary actuation apply the torque needed for the pitching of the rotor blade by a motor with the associated rotary drive. The torque is transmitted by the pitch teeth to the blade bearing fixed to the rotor blade.
- Systems with a hydraulic blade pitching mechanism apply the torque for the pitching of the rotor blades by one or more hydraulic cylinders. The torque is transmitted by the piston rod directly or indirectly to a linking point fixed to the rotor blade.

For the calculation of the loading of a blade pitching system, the design loads as per Section 5 shall be applied. Static and load-dependent blade bearing friction torque shall be taken into account.

For the fatigue analysis, the load duration distributions (LDD) and the load spectra shall be used. A distinction shall be made between operations with and without blade pitching.

10.2.1 Systems with rotary actuation

In case of pitch systems with a pitch gearbox, the gear load capacity calculation of the pitch gearbox and pitch teeth shall be based on the ISO 6336 series. The calculation of the fatigue load capacity of gears shall be performed according to ISO 6336-6:2006 using the LDD or using an equivalent torque derived from the LDD according to ISO 6336-6:2006, Annex A. Furthermore, an analysis of the static strength against tooth breakage and pitting is required. Both analyses shall be in compliance with safety factor as required by Table 10-2.

Table 10-2 Minimum safety factors of pitch toothing for medium risk level

<i>Minimum fatigue safety factor for pitch gearbox and blade bearing teeth</i>	<i>Gearbox</i>	<i>Pitch Teeth</i>
Surface durability SH	1.0	1.1
Tooth root breakage SF	1.15	1.25
<i>Minimum static safety factor for pitch gearbox and blade bearing</i>	<i>Gearbox</i>	<i>Pitch Teeth</i>
Surface durability SH	1.0	1.0
Tooth root breakage SF	1.1	1.2

10.2.2 Systems with hydraulic actuation

For the components of the blade pitching mechanism, actuated e.g. by one or more hydraulic cylinders, a fatigue strength analysis and a static strength analysis shall be assessed for all load-transmitting components and connecting elements.

10.2.3 Blade bearings

Blade ball or roller bearings predominantly loaded by small back-and-forth motions shall have their static rating derived directly from the calculated maximum contact stress between rolling elements and raceway. The maximum permissible Hertzian contact stress shall be defined by the bearing manufacturer with consideration for the material, surface hardness and hardening depth, and shall be documented in the design calculation. The static safety factor for the Hertzian contact stress shall be at least 1.1. A proof against core crushing has to be supplied for the bearing raceways for extreme and fatigue loads.

If a plain bearing is applied as blade bearing the static safety factor for the maximum allowable surface pressure as specified by the bearing manufacturer shall be at least 1.1. A wear calculation shall be provided for plain bearings taking into account local surface pressure and accumulated sliding distance from bearing rotation.

Blade bearings lubricated by grease or oil require a secondary seal between the blade and the hub structure/spinner of the HATT to protect them from contact with seawater. The vicinity between secondary seal and bearing shall be monitored for leakage.

10.2.4 Electrical drives in pitch systems

The basis for thermal rating of an electrical drive shall be the most severe torque-time simulation run with the highest-torque rms value. The averaging time shall be 600 seconds, or the overall time of the simulation run to be used. This simulation run and the information about which load case was used shall be submitted for assessment. The thermal rating of an electrical drive shall be determined by using IEC 61800-6 or IEC 60034-1.

10.3 Yaw system

This section applies for the yaw systems of HATT as described below. Yaw systems are used to align the rotor of the HATT to the tidal current. In the event of other designs, the wording shall apply with the necessary changes.

- Systems with rotary actuation apply the torque needed for the yawing of the HATT nacelle by a motor with the associated rotary drive. The torque is transmitted by the yaw teeth to the yaw bearing fixed to the support structure of the HATT
- Systems with lateral thrust units (similar to bow thrusters as found on larger vessels) for yawing the HATT nacelle

10.3.1 Systems with rotary actuation

In case of yaw systems with yaw gearboxes, the gear load capacity calculation of the yaw gearboxes and yaw teeth shall be based on the ISO 6336 series. The calculation of the fatigue load capacity of gears shall be performed according to ISO 6336-6:2006 using the LDD or using an equivalent torque derived from the LDD according to ISO 6336-6:2006, Annex A. Furthermore, an analysis of the static strength against tooth breakage and pitting is required. Both analyses shall be in compliance with safety factor as required by Table 10-3. If Brakes attached to the yaw drive motors are used as yaw brake instead of a yaw brake working independently of the yaw gearboxes the resulting alternating loads on the yaw gear teeth shall be included in their fatigue calculation

Table 10-3 Minimum safety factors of yaw toothing for medium risk level

<i>Minimum fatigue safety factor for Yaw gearbox and yaw bearing teeth</i>	<i>Gearbox</i>	<i>Yaw Teeth</i>
Surface durability SH	1.0	1.1
Tooth root breakage SF	1.15	1.2
<i>Minimum static safety factor for yaw gearbox and yaw bearing</i>	<i>Gearbox</i>	<i>Yaw Teeth</i>
Surface durability SH	1.0	1.0
Tooth root breakage SF	1.1	1.2

10.3.2 Systems with lateral thrust units

In case of yaw systems using one or more lateral thrust units these are usually mounted externally at the HATT nacelle. The units shall provide at least 1.1 times the thrust required to align the rotor from any position to the tidal current at maximum operational current, taking into account the load-dependant friction torque of the yaw bearing. When using lateral thrust units for the yaw system of HATT, the application of a fail-safe yaw brake is mandatory.

10.3.3 Yaw bearings

Yaw ball or roller bearings predominantly loaded by small back-and-forth motions shall have their static rating derived directly from the calculated maximum contact stress between rolling elements and raceway. The maximum permissible Hertzian contact stress shall be defined by the bearing manufacturer with consideration for the material, surface hardness and hardening depth, and shall be documented in the design calculation. The static safety factor for the Hertzian contact stress shall be at least 1.1. A proof against core crushing has to be supplied for the bearing raceways for extreme and fatigue loads.

If a plain bearing is applied as blade bearing the static safety factor for the maximum allowable surface pressure as specified by the bearing manufacturer shall be at least 1.1. A wear calculation shall be provided for plain bearings taking into account local surface pressure and accumulated distance from bearing rotation.

Yaw bearings lubricated by oil or grease require a secondary seal between the nacelle and the support structure of the HATT to protect them from contact with seawater. The vicinity between secondary seal and bearing shall be monitored for leakage.

10.4 Drivetrain

10.4.1 Rotor shaft

Ultimate and fatigue strength of the rotor shaft shall be proved according to international standards (e.g. FKM Guideline "Analytical strength assessment of components in mechanical engineering").

Rotor shafts which are not made of corrosion-resistant material and which run in seawater are to be protected against ingress with seawater by seawater-resistant metal liners or other liners approved for seagoing vessels.

The minimum wall thickness of a metal liner shall be not less than 3% of the main shaft diameter below the liner.

10.4.2 Main bearings

The guidelines of this section apply to roller bearings intended as rotor, gearbox or generator bearings in the drive train of a HATT and for plain bearings intended as rotor bearings of a HATT.

For roller bearings used in the drive train, a static rating according to ISO 76:2006 shall be submitted. The static safety factor S_0 shall be at least 2.0.

A basic (L10) or modified (L10m) rating life calculation according to ISO 281:2007 or a modified reference rating life calculation (L10mr) according to ISO/TS 16281:2008 shall be provided for the drive train bearings. The life modification factor a_{ISO} shall be limited to 3.8. All input parameters of the modified rating life and modified reference rating life calculations shall be included in the documentation.

For the calculation of the rating life a LDD shall be determined from the time series of the fatigue loads as per Section 5. The LDD determines the sum of revolutions n_i of the bearing during which the equivalent dynamic bearing load P_i acts within the individual class limits. A reduction of the specified spectrum to 10 load levels in accordance with Miner's rule is permissible. The life exponent for reducing the number of load levels shall correspond to the exponent used in the bearing calculation. For the analysis of the basic rating life and the modified rating life according to ISO 281:2007, the equivalent bearing load averaged over the lifetime can be calculated then as follows:

$$P = \sqrt[p]{\frac{\sum P_i^p n_i}{N}}$$

where:

P_i = equivalent dynamic bearing load

p = 10/3 for roller bearings; 3 for ball bearings

n_i = number of revolutions during which P_i acts.

The combined modified rating life according to ISO/TS 16281:2008 is obtained as:

$$L_{10mr} = \frac{\sum q_i}{\sum \frac{q_i}{L_{10mr i}}}$$

where:

L_{10mr} = combined modified rating life of the bearing

q_i = time share on the i^{th} load level

$L_{10mr i}$ = modified rating life of the bearing on the i^{th} load level

The modified rating life according to ISO 281:2007 shall be at least 130,000 hours, the modified reference rating life according to ISO/TS 16281:2008 shall be at least 175,000 hours or the operating lifetime of the HATT.



For plain bearings used as main bearings on rotor shafts of HATT the contact load, calculated from the static load during still stand and allowing for the weight of the rotor, shall be less than 0.8MPa for white metal bearings and less than 0.6MPa for bearings made of synthetic materials. For approved materials higher surface pressure values may be applied. It shall be shown for all power production load cases that hydrodynamic plain bearings on the rotor shaft are operated at a Sommerfeld Number $S_o < 10$. Supply of hydrodynamic plain bearings with hydrostatic pressure during start sequences of the HATT is recommended to avoid wear and to facilitate the start procedure.

10.4.3 Main gearbox

The load-transmitting parts of a HATT gearbox are statically and dynamically loaded by the rotor torque. The dynamic portion depends on the characteristics of the driving side (rotor) and the driven side (generator) and also on the masses, stiffness and damping values in the driving and driven portions (shafts and couplings) and the external operating conditions imposed on the HATT. Depending on the drive train concept of the HATT, additional loads in the form of forces and bending moments might be considered at the gearbox input shaft and the gearbox output shaft for the gearbox strength calculations.

Using the time series of the fatigue loads (e.g. torque), the load duration distribution (LDD) shall be determined for the calculation of gears, bearings, shafts and gearbox structures.

A strength calculation for the gears according to ISO 6336 shall be provided.

- a) For torque-transmitting gears, a service life calculation according to ISO 6336-6:2006 (pitting, tooth breakage) using the LDD or a load capacity calculation using an equivalent torque derived from the LDD according to ISO 6336-6:2006 Annex A shall be submitted. The Palmgren-Miner's sum used in the service life calculation shall be less or equal to 1. The endurance limits for the gear materials shall comply with ISO 6336-5:2003. Sufficient load capacity shall be verified for all meshes in the main gearbox of the tidal turbine. The required minimum safety factors are listed in Table 10-4.
- b) For torque-transmitting gears, a static strength analysis according to ISO 6336-2/3:2006 (pitting, tooth breakage) shall be submitted. Sufficient load capacity shall be verified for all meshes in the main gearbox of the tidal turbine. The required minimum safety factors are listed in Table 10-4.
- c) A scuffing analysis according to DIN 3990-4:1987 or ISO/TR 13989:2000 shall be submitted. This analysis shall cover calculations according to the flash temperature method and according to the integral temperature method. The scuffing capacity of the oil shall be determined by the scuffing test FZG A/8.3/90 according to ISO 14635-1:2000. If the scuffing temperature is determined from FZG tests, one stage lower than the fail load stage shall be used for the scuffing analysis. Sufficient load capacity shall be verified for all meshes in the main gearbox of the tidal turbine. The required minimum safety factors are listed in Table 10-4.
- d) A micropitting analysis according to ISO/TR 15144-1:2009 using the design load shall be submitted. Sufficient load capacity shall be verified for all meshes in the main gearbox of the tidal turbine. The required minimum safety factor is listed in Table 10-4.
- e) A load distribution analysis (contact analysis) shall be submitted. The load distribution shall be verified by numerical evaluation with an advanced contact analysis that allows analysis of the load distribution in the helix direction and profile direction simultaneously, providing full information of the local loading in the entire contact area.

- f) Additionally, maximum operating loads and tolerance combinations in accordance with ISO 6336-1:2006 shall be checked with their resulting contact stress. Special care shall be taken to avoid stress raisers at the extremities of the contact area.

Table 10-4 Minimum safety factors for medium risk

	<i>Safety factor for pitting S_H</i>	<i>Safety factor for tooth breakage S_F</i>	<i>Safety factors for scuffing S_B and S_{ints}</i>	<i>Safety factor for micropitting S_A</i>
Rated load (LDD)	1.25	1.56	-	1.2
Extreme Load	1.0	1.4	-	-
Highest torque from LDD	-	-	1.5	-

The Influence factors for the load capacity calculations shall be applied as follows:

- Application factor K_A
 - For a service life calculation according to ISO 6336-6:2006 using the LDD (see GL2012 Part IV Part 2 Section 7.4.4.2), K_A equals 1.0.
 - For a load capacity calculation using an equivalent torque, the application factor K_A shall be determined according to ISO 6336-6:2006 Annex A from the LDD for each mesh.
 - The static strength analysis for the gears shall be carried out using the extreme load and $K_A = 1.0$.
- Dynamic factor K_V
 - The dynamic factor K_V shall be calculated according to ISO 6336-1:2006 Method B. Without a detailed dynamic analysis, $K_V < 1.05$ is not permissible.
- Load distribution factor K_y
 - The load distribution factor K_y in gearboxes with dual or multiple load distributions or, in the case of planetary stages, with more than two planet wheels shall be chosen in accordance with Table 10-5.

Table 10-5 Load distribution factor for planetary gearboxes

Number of planet wheels	3	4	5	6	7
load distribution factor K_y	1.0	1.25	1.35	1.43	1.5

- Face load factors $K_{H\beta}$, $K_{F\beta}$ and $K_{B\beta}$
 - The face load factors shall be determined by sophisticated calculation models, as described in ISO 6336-1:2006 annex E. $K_{H\beta} < 1.15$ is not permissible.
- Transverse load factors $K_{H\alpha}$, $K_{F\alpha}$ and $K_{B\alpha}$
 - With gear accuracy as per ISO 1328-1:1995 of at least accuracy grade 6 for surface-hardened external and internal gears and at least accuracy grade 8 for through-hardened internal gears the transverse load factors can be set to unity.
- Life Factors Z_{NT} and Y_{NT}
 - The life factors Z_{NT} according to ISO 6336-2:2006 and Y_{NT} according to ISO 6336-3:2006 shall be set to 0.85 at $N_L = 10^{10}$.



For ground external and internal gears, the maximum arithmetic surface roughness shall be $R_a \leq 0.8 \mu\text{m}$. The maximum arithmetic surface roughness for through-hardened internal gears shall be $R_a \leq 1.6 \mu\text{m}$. Integer ratio designs, e.g. $z_1/z_2 = 21/63$, are not allowed.

Fatigue and static analyses (general stress analyses) shall be carried out for all gearbox shafts. For connecting elements (e.g. keys, slip joints, press fits), only a static analysis is required. The analyses shall be performed for shafts in accordance with the DIN 743 series, for keys in accordance with DIN 6892:2012 and for press fits in accordance with DIN 7190:2001, or equivalent codes.

10.4.4 Coupling (and high speed shaft)

In the general strength analysis of the respective coupling, the maximum torque resulting from the design loads as per Section 5 shall be used as the basis. Continuous transmission of that maximum torque is not necessary, but the loading caused by its occurrence shall not result in damage to the coupling.

If a reduction in that maximum value is achieved by design measures (e.g. a slipping coupling), the reduced value might be used for the coupling design. Here the tolerance of the slipping torque shall be considered. The constancy of the slipping torque over the lifetime or until the next maintenance shall be proven for each limiter design. The results can be transferred to limiters with other sizes but with the same design.

The forces resulting from axial, radial and angular misalignment of the coupling shall be taken into account in the strength calculations of the coupled drive train components.

10.4.5 Mechanical brakes

A mechanical brake shall be specified by its maximum and minimum brake torque, defined by respective upper and lower limits of actuator force and friction coefficient of brake liners. For the strength calculation of the brake components and their fastening the maximum brake torque shall be applied. If a mechanical brake is used to bring the rotating drivetrain to a standstill it has to be shown that the maximum brake torque including dynamic magnification as calculated per Section 5 does not damage the drivetrain components or the structure of the HATT.

In case the mechanical brake is required to prevent over speed of the HATT, the minimum brake torque has to be applied for calculating the respective load case. It has to be shown that the dissipated heat during the worst-case braking event does not damage the brake system or adjacent components.

If a mechanical brake is used as a parking brake to prevent the rotor from turning during ROV access, lifting or deployment of a HATT, a risk analysis of the mechanical brake shall include loss of actuator force, contamination of friction surfaces and brake lining wear.

Mechanical brakes located on the high speed shaft of the gearbox shall not be used as parking brakes during towing operations of the HATT. A rotor lock located at the rotor shaft shall be used instead.

In the case if the cycling loading is inessential, mechanical brakes located on the high speed shaft of the gearbox can be used as parking brakes during towing operations of the HATT. Otherwise a rotor lock located at the rotor shaft shall be used.

10.4.6 Locking devices

Depending on the design of the HATT a rotor lock mechanism might be required to prevent unintended turning of the rotor during maintenance, transportation and erection of the HATT.



For the general strength analysis of the rotor lock mechanism the maximum rotor lock torque resulting from the design loads as per Section 5 shall be used. The strength analysis shall include all load-transmitting parts of the rotor lock. The lock pin shall be verified regarding shear and bending stresses and surface pressure. In case two or more lock pins are applied simultaneously the load distribution on the individual shall consider the manufacturing tolerances and adjustment capabilities.

10.5 Auxiliary systems

Auxiliary Systems include the cooling systems of gearbox, inverters, generator and hydraulics as applied on the respective HATT design. It might include depending on the design of the HATT a drainage system for the bilge and catch tanks as well as a ballast system.

10.5.1 Bilge

HATTs with a pressurized nacelle vessel require a bilge drainage system. The arrangement of the drainage system shall be so that no sea water can unintentionally enter the dry nacelle compartment.

Two non-return valves in series shall be installed between sea and bilge suction in the nacelle. Bilge and bilge suction shall be designed in a way that clogging of the bilge suction is safely prevented. Leakage catch tanks e.g. of rotor shaft seals shall be connected to the bilge drainage system. Access to valve actuators and the respective fittings at the outside of the pressurized nacelle shall enable bilge drainage by external means (e.g. ROV/umbilicals).

For the remotely operated valves in a HATT, failure in valve control system shall not cause:

- Opening of closed valves
- Closing of valves that need to remain open to maintain power production or integrity of the HATT.

The piping, fittings and pumps of the bilge drainage system shall be designed in accordance with DNV Rules for Classification of Ships, Part 4 Chapter 6, Section 7. Piping systems are to be dimensioned for a design pressure PR equal to the maximum allowable working pressure PB. All piping systems which may be loaded with the diving pressure are to be designed additionally for 1.0 times the collapse diving pressure CDP (according to the load case from outside or inside).

Guidance note

The collapse diving pressure (CDP) is the pressure for which the pressure hull/nacelle will collapse under load without consideration of the creeping behaviour and the creep rupture strength of the material. Reference is made to GL Rules for Classification and Construction - I Ship technology - Part 5 "Underwater Technology", Chapter 3 "Unmanned Submersibles (ROV, AUV) and Underwater Working Machines", Section 5 D.

---e-n-d---of---G-u-i-d-a-n-c-e---n-o-t-e---

Water levels in bilge and catch tanks shall be recorded by the HATT controller to monitor the integrity of the nacelle and the rotor shaft seal. Based on pump capacity of the bilge drainage system a FMEA in accordance with Section 2 shall be performed to define leakage rates at which the HATT has to be stopped respectively recovered to avoid damage of the HATT or the maritime environment.

10.5.2 Pressure hull, ballast system and buoyancies

A HATT might be equipped with a ballast system and buoyancies to facilitate submerging and lifting the HATT or to reduce structural loads during operation of the HATT.

Buoyancies shall meet the requirements for externally pressurized vessels as described in Section 8.

The structural loads resulting from ballasting and buoyancies shall be taken into account in the strength analysis of the HATT structure. In Application of the ballast system during submerging and lifting of the HATT requires a detailed analysis of the ballast system design in the FMEA for the lifting and submerging procedures.

Two non-return valves in series shall be installed between ballast system and bilge suction in the nacelle.

A pressure hull is a structure under external pressure which might be used on HATTs to provide a dry compartment for the drivetrain and/or auxiliary mechanical and electrical devices. A buoyancy is an externally pressurized vessel attached to the HATT to provide additional lift. For the strength calculations of the pressure hull and buoyancies three water depths have to be taken into account for calculation of the loads by external pressure.

10.5.3 Heating ventilation and air conditioning

The humidity inside pressurized nacelles shall not exceed 60% rel. Depending on the external conditions a HATT might require heating of cabinets or the entire nacelle atmosphere to avoid condensation of moisture on sensitive components. Condensate from dehumidifiers can be departed into the bilge.

The atmosphere inside the nacelle shall be constantly monitored for combustible gases and aerosols during operation of the HATT. Thorough venting of the nacelle has to be provided before and during operations of maintenance personal inside the nacelle are performed.

Depending on the external conditions and the duration of production and still stand of the HATT in the tidal cycles, heaters for gearbox oil and hydraulic fluid might be required to reduce wear of components and ageing of fluids induced by thermal cycling.

Before entering the turbine for maintenance or other works care shall be taken to free enclosed compartments from all dangerous gases accumulating there due to fouling. Ventilation system (fans, air pipes, filters) capable for duly ventilation of all spaces where work to be performed in, shall be provided. Care has to be taken that no explosive atmosphere is built up in spaces where ignition is possible. Start-up of the forced ventilation must be possible from outside of the turbine.

10.5.4 Cooling

All fittings, coolers and piping systems of sea water coolers which may be loaded with the diving pressure are to be designed additionally for 1.0 times the collapse diving pressure CDP (according to the load case from outside or inside). Sea water cooling systems require constant monitoring of the primary circuit for seawater ingress due to leakage (monitoring conductivity on water based primary coolants and water content on oil).

There shall be at least two sea water inlets for the cooling system. The wake effect of the rotor shall be taken into account for the positions of the inlets on the nacelle to avoid negative impact on cooling system performance. Where sea water is used for cooling the main engines or



auxiliary engines, the cooling water, suction lines shall be provided with strainers which can be cleaned without interrupting the cooling water supply.

In case the pressurized shell of the nacelle is used as a heat exchanging surface for the cooling system, additional stresses due to thermal expansion shall be considered in the strength calculation of the nacelle structure.

10.6 Hydraulic system

10.6.1 Documentation

Hydraulic systems for operation of e.g. rotor blade pitch control or forming part of brake systems shall be designed in accordance with recognized standards like ISO 4413. The documentation of the hydraulic system shall include a hydraulic functional diagram in standard form as per ISO 1219-2 with associated parts list and electrical circuit diagrams showing the actuation of the hydraulic system valves. For all safety-related components data sheets have to be provided.

10.6.2 Design requirements

Seamless or longitudinally welded steel pipe shall be used for piping. Suitable high-pressure hoses in accordance with international codes shall be used as flexible pipe connections. Pressure fluctuations shall be considered to calculate the lifetime of the hoses and the related replacement intervals.

A clear separation is required for the components and assemblies of independent braking systems.

The hydraulic system should be designed for the HATT entering a safe condition in case of pressure loss or failure of the hydraulics. This includes grid loss or failure of the power supply to the pump or the valves.

Leakage of the hydraulic system shall be detected by e.g. level sensors in the fluid tank and shall not impair the system's ability to bring the HATT to a safe condition.

11 PROTECTION FUNCTIONS AND SAFEGUARDING

11.1 General

Meeting the requirements of this section contributes essentially towards reducing risks as defined in [1.10.3.3] through

- ensuring that the tidal turbine and its components are always kept within their design limits
- preventing the damage of the tidal turbine components due to internal faults (e.g. leakage, short circuit)
- elimination of hazards i.e. potential sources of physical injury or damage to the health of persons, of damage to investments or of damage to the environment, or reduction of the risks related to these hazards.

For this purpose, a risk assessment shall be carried out to assess the overall tidal turbine design based on principles described in [1.10.3.3] in order to identify necessary

- functions of the control and safety systems ensuring efficient and safe operation of the tidal turbine,
- protection functions required to keep the tidal turbine within the design limits,
- safeguarding within construction, transport installation and maintenance works.

11.2 Control system and control concept

11.2.1 Control system

A control system controls, regulates and monitors tidal turbine efficiently, keeping tidal turbine within the normal operating limits by appropriate corrective actions such as

- gentle shut-down i.e. gentle deceleration of the rotor and termination of turbines power production
- reduction of operational mode (de-rated operation)
- correction of nacelle position (yawing / untwisting)
- start-up of drain, ventilation systems
- transmission of alarm to remote control station
- automatic (re)start of the turbine
- limitation of turbines automatic restarts number.

11.2.2 Control concept

The control concept is a strategy defining the control system behaviour with the target of efficient, lightly stressed and safely operation of tidal turbine as free from malfunctions as possible. In the control concept the structural integrity of the tidal turbine shall be given priority over its availability.

Based on the results of the risk assessment with consideration of load simulations, design assessment of foundation / blades / electrical equipment / machinery components, the control



concept shall define the behaviour of the control system in order to keep the operational conditions inside the normal operating limits.

The design documentation shall describe all relevant operational and external conditions, for example the following:

- rotational speed
- electrical power, frequencies and voltages
- grid loss
- grid disturbance
- operational vibration
- current speed
- current direction
- cable twisting
- allowable difference between measured and demanded blade pitch angle and individual blade pitch angles
- allowable pitch angle range
- automatic activation of the hydrodynamic brakes
- control system hang detection (by watchdog)
- mechanical brake wear detection
- functionality of essential machinery components
- leakage detection (low level)
- plausibility of measurements (pitch angle, current speed, current direction)
- health and status of navigation / collision warning equipment
- air condition in the nacelle.

The instrumentation necessary for the control system's monitoring of operational and external conditions shall be in compliance with the requirements of [11.5].

Normal operating limits of the control system shall be defined so that control system is not disturbed unnecessarily by the safety system

11.2.3 Automatic re-start

The tidal turbine can be re-started automatically by the control system, if a shutdown was performed by the control system due to exceedance of operating limits. Depending on the results of the risk assessment, the following considerations shall be taken into account within the definition of the automatic restart procedure:

- present external conditions (e.g. current direction, current speed, availability of grid, etc.) and operational requirements for the start or re-start of the tidal turbine (e.g. heat-up of gear-box, degassing of the nacelle, mechanical brake condition, etc.);

- allowable number of automatic re-starts depending on the detected fault (e.g. one time every 24 hours in the case of the control system hang detection; three times every 24 hours in the case of exceedance of operational vibration limit; etc.).

In the case that the allowable number of automatic turbine re-starts is defined, and this number is achieved, the safety system shall be triggered. The counting of the performed gentle shut downs can be undertaken separately for each defined operating limit.

11.3 Safety system and safety concept

11.3.1 Safety system

The safety system is a system logically superordinate to the control system and is brought into action after safety-relevant limiting values have been exceeded or if the control system is incapable to keep the tidal turbine within the normal operating limits.

The safety system shall

- have priority over the control system
- supervise the functionality of the control system
- upon its trigger take-over tidal turbines control from the control system
- upon its trigger exclude the automatic restart of the tidal turbine.

Depending on the safety concept, the safety system upon its trigger is intended to keep the tidal turbine in a safe condition by the correspondent combination of following actions:

- rapid shut down i.e. rapid deceleration of the rotor (e.g. by means of blades pitching, application of mechanical disk brake) and termination of turbines power production
- disconnection of the generator from the grid and de-energising of turbines medium- and the high-voltage systems
- prevention of further nacelle rotation
- prevention of the automatic restart of the turbine.

Regardless of tidal turbines operational mode (e.g. power production, parked, grid loss or maintenance) the safety system shall

- be either operational (ready) or activated (triggered)
- have access to at least two mutually independent braking systems
- have access to the equipment for the grid disconnection of the generator.

Guidance note

Safety system can be deactivated prior the retrieval of the tidal turbine and during the time the tidal turbine is out of its foundation to avoid unwanted automatic safety system action.

---e-n-d---of---G-u-i-d-a-n-c-e---n-o-t-e---

11.3.2 Safety concept

The safety concept is a strategy defining the safety system behaviour with the target to ensure that tidal turbine remains in a safe condition in the event of exceedance of safety-relevant



limiting values due to e.g. malfunction of the control system, activation of the emergency stop button.

Based on the results of the risk assessment with consideration of the load simulations and the design assessment of the foundation / electrical equipment / machinery components, the safety concept shall define the behaviour of the tidal turbines the safety system in the case of exceedance of safety-relevant limiting values.

Description shall be given for all relevant operational conditions, for example the following:

- rotational speed
- electrical power
- excessive vibration / shock
- excessive cable twisting
- short circuit in the electrical power system
- emergency stop
- dysfunction of the control system
- frequent exceedance of normal operating limits
- leakage detection (high level).

Requirements on the instrumentation monitoring of exceedance of safety-relevant limiting values shall be observed in accordance with section [11.5].

The safety-relevant limiting values of the safety system shall be defined so that the limitations from the design basis are not exceeded and tidal turbine structural integrity is not endangered. They shall be taken into account correspondingly within the load calculation.

If the safety concept requires termination of the power production and disconnection of the generator from the grid, this does not need to be carried out instantly. Excessive speeding-up of tidal turbine, or operation of the generator as a motor, shall be avoided in any case.

11.3.3 Clearance

Once triggered by safety-relevant limiting values, clearance of the safety system is required in any case. Clearance is a human intervention in the sense of the execution of a necessary repair or elimination of the cause of a malfunction, followed by release of tidal turbine into operation.

The clearance can be performed from the remote control centre, if the following prerequisites are met:

- The inside of the nacelle shall be inspected after the clearance and during the start-up procedure, to make sure that the main components are in place and undamaged. This inspection may be conducted by using monitoring cameras and microphones or other suitable methods installed in the tidal turbine. If such an inspection is not possible due to design concept of the tidal turbine, self-testing implemented in the control system shall be possible.
- If the safety system was triggered before grid loss, upon grid recovery the clearance shall be still required for the release of the tidal turbine into operation.

- In order to reduce the risks associated with unintended remote resets, the reliability and integrity the safety system reset functionality (including associated communication systems, protocols and networks) shall be at least as high as of the safety system functions that can be reset.

11.4 Protection functions

Functions of the control and safety systems essential to ensure that the turbine remains within its design limits are counted to the protection functions. This section

- shows up which only functions of the control and/or safety system shall be attributed to the protection functions,
- specifies requirements to the protection functions in order to ensure their appropriate reliability.

A function of the control and/or of the safety system shall be counted to the protection functions if a dangerous event can potentially result in the exceedance of the ultimate strengths endangering thus directly the structural integrity of the tidal turbine.

A function of the control and/or of the safety system shall not be counted to the protection functions if it is proved that its unavailability will not immediate increase the risk of the structural damage e.g. due to following reasons:

- there is a protection function in place that is independent of the function under consideration and that still keeps the turbine within the design limits
- the unavailability of the function and thereby caused consequences (e.g. fatigue effects, corrosion, erosion, scour development) can be detected in good time e.g. during the next maintenance, by means of the condition monitoring of the tidal turbine, etc.

The targets of the protection function are

- continuous monitoring whether correspondent limiting value is achieved, and
- initiation of the correspondent action upon correspondent limiting value is achieved.

Failure of a single component shall not lead to loss of the protection function.

Reliability of the protection functions (including architecture of the protection function, reliability of its components, software requirements, etc.) shall be analysed and be in compliance with a state of the art standard functional safety standard e.g. ISO 13849-1, IEC 62061 or IEC 61508.

Guidance note

ISO 13849-1 provides guidance for the determination of the performance level required for a protection function (PL_r).

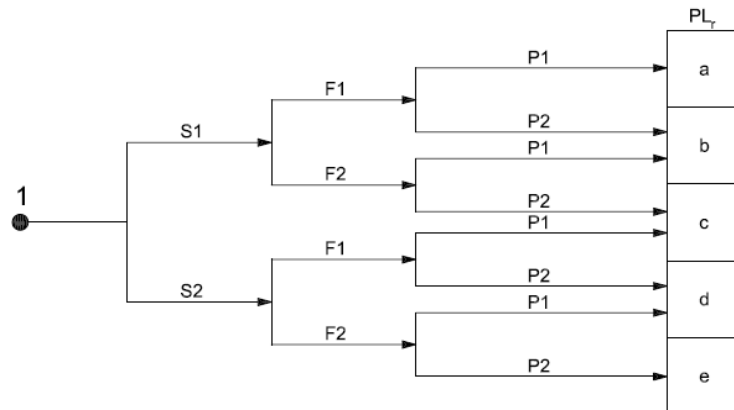

Figure 11-1 Risk graph for determining of required performance level (PL_r) for protection functions

ISO 13849-1 does not deal with the risk and/or damage to property or the environment, and covers only risks coupled with safety of persons. This tidal turbine Standard provides the following extended methodology for the determination of the required performance level for all categories of risks considered in [1.10.3.3]. See Table 11-1.

Table 11-1 Consequence levels

<i>Risk parameters according to ISO 13849-1</i>	<i>Risks to personal</i>	<i>Risks to investments</i>	<i>Risks to environment</i>
S1 severity of impact	Normally reversible injury	Normally repairable turbine damage / cost < 100.000€	Normally reversible minor pollution / slight effect on environment (minimum disruption on marine life)
S2 severity of impact	Normally irreversible injury or death	Major or unrepairable turbine damage / cost > 100.000€	Moderate to significant clean-up costs (over 100.000€) / disastrous effects on the environment that cause permanent or long lasting environmental damage
F1 frequency of failure / fault / hazard occurrence and exposure time	Seldom-to-less-often (and/or exposure time is short)	Seldom-to-less-often i.e. less frequent than 10 ⁻³ p.a. / exposure time is short	Seldom-to-less-often i.e. less than 10 ⁻³ p.a. / exposure time is short
F2 frequency of failure / fault / hazard occurrence (exposure time)	Frequent-to-continuous (and/or exposure time is long)	Frequent-to-continuous i.e. oftener than 10 ⁻³ p.a. / exposure time is long	Frequent-to-continuous i.e. oftener than 10 ⁻³ p.a. / exposure time is long
P1 possibility of avoiding failure / fault / hazard or limiting impact	Possible under specific conditions	possible under specific conditions	possible under specific conditions
P2 possibility of avoiding failure / fault / hazard or limiting impact	Scarcely possible	scarcely possible	scarcely possible

---e-n-d---of---G-u-i-d-a-n-c-e---n-o-t-e---

11.5 Instrumentation of the control and safety systems

Instrumentation and logic of the control and safety systems includes whole equipment necessary for the implementation of the functions of the control and safety systems:

- input elements (sensors, meters, gauges, detectors, measuring transducers, push-buttons, etc.)
- logic units (e.g. PLC, microcontrollers, relays)
- output of the power control (e.g. contactor of relay, solenoid valves, frequency converters, etc.)

Guidance note

Actuators (pitch motors, yaw motors, hydraulic cylinders, drain pumps, ventilators) shall be attributed to the correspondent actuating mechanisms (see [11.6]) rather than to instrumentation of the control and safety systems.

---e-n-d---of---G-u-i-d-a-n-c-e---n-o-t-e---

All measurements shall be protected effectively against external influences. Location and fastening of sensors shall ensure reliable and independent measurements.

Averaging time for measurements in scope of control and safety concepts shall be defined in accordance with the provisions of this section.

11.5.1 Rotational speed

If the measurement of the rotational speed is required by the design concept of the tidal turbine, there shall be at least two independent measurements of speed by the control system. At least one of these measurements shall be performed at the turbine component that runs at rotor speed. Plausibility check of the measured rotational speeds shall be continuously carried out by the control system.

Gentle shut down of tidal turbine performed by the control system is required

- in the case of detection of an error within the monitoring of mutual plausibility of measurements,
- in the case if normal operating limit (cut-out rotor speed n_4) is exceeded.

Measurement of the rotational speed by the safety system shall be carried out at least once. If correspondent safety-relevant limiting value (activation rotor speed n_A) is exceeded, rapid shut down of the tidal turbine by the safety system shall be performed by the safety system.

11.5.2 Electric power

Electric power in combination with the rotational speed is regarded as a measure of the average loading of the turbine. The active electrical power shall be used as the measurement parameter.

In the scope of the control concept the power measuring equipment shall be capable of picking up both long-term average values (about 1–10 minute mean) and short-term power peaks (sampling rate at least once per second). If normal operating limit (over-power P_T) is exceeded, power reduction or gentle shut down of tidal turbine shall be performed by the control system.

The power shall be monitored continuously for exceeding of the instantaneous activation power P_A . If correspondent safety-relevant limiting value is exceeded, rapid shut down of the tidal turbine shall be performed by the safety system.

11.5.3 Voltage and frequency

In scope of control concept voltage and frequency shall be measured by the correspondent equipment as per Section 12. If voltage and / or frequency deviations are out of range defined for normal external conditions, the control system decides whether a grid disturbance or a grid loss has occurred. In the case of grid loss, gentle shut-down of the turbine performed by the control system is required.

11.5.4 Excessive foundation vibration

Sensors for constant monitoring of excessive vibration in the scope of the safety concept shall be located at nacelle height, mounted away from any nacelle rotational axis. The sensitivity of the sensor shall be matched to the conditions prevailing. Measurement techniques sensing the absolute movement shall be used. If the correspondent safety-relevant limiting value is exceeded, rapid shut down of the turbine shall be performed by the safety system.

The same instrumentation principle shall be also applied in the scope of the control concept, if required. The necessity of the integration of the excessive vibration monitoring into the control concept depends on the results of the load simulations, and is required for

- pitch-controlled turbines if cyclic collective pitch movements cannot be ruled out and excite cyclic movements of the foundation/tower head
- turbines operating in the resonance range close to the natural frequency of the foundation/tower
- turbines, for which hydrodynamically excited blade vibrations cannot be ruled out (in this case the necessity of the installation of the excessive blade vibration monitoring shall be considered as well).

Normal operating limits shall be defined for short-term monitoring (with measurement period up to a few seconds) and long-term monitoring (with measurement period in the range of several minutes). Gentle shut down of the tidal turbine by the control system is required if normal operating limits are exceeded.

11.5.5 Current speed

If safe operation of the tidal turbine depends on current speed measurements, or if current speed is one of the input parameters to the control system, a reliable current speed measurement in the scope of the control concept shall be provided. This requirement can be met by measuring the speed either directly or via another parameter with a clear and recognized relationship to it, which is then processed. As a matter of principle, suitable sensing points and measurement techniques shall be selected for operational measurements. The current speed at hub height – with flow as undisturbed as possible – is to be considered as relevant measurement parameter.

Reliable monitoring of normal operating limits (long term cut-out current U_{out} , short term cut-out current speed U_A) shall be provided if it is required by the design concept of the tidal turbine. Gentle shut down of the tidal turbine performed by the control system is required

- in the case of detection of an error within the monitoring of mutual plausibility of measurements, and
- in the case if normal operating limits are exceeded.

11.5.6 Current direction

Reliable monitoring of normal operating limits (cut-out yaw error φ_A) shall be provided if it is required by the design concept of the tidal turbine. Gentle shut down of the tidal turbine performed by the control system is required

- in the case of detection of an error within the monitoring of mutual plausibility of measurements, and
- in the case if normal operating limit is exceeded.

11.5.7 Blade pitch angle

The blade pitch angle shall be constantly monitored in pitch-controlled turbines. Reliable monitoring of

- the deviation between the demanded value of the pitch angle and the currently measured pitch angle (in turbines with independent blade pitching measured at every single blade),
- the allowable blade pitch angle range (by means of e.g. end switches at every single blade for both fine and feather limits), and
- the difference between individual blade pitch angles (in turbines with independent blade pitching)

shall be provided.

If normal operating limits are exceeded, gentle shut down of the tidal turbine shall be performed by the control system.

11.5.8 Short-circuit

The main power circuits shall be equipped with suitable short-circuit protection devices. These devices shall fulfil the requirements in [12.7.3]. If the protection devices detect a short circuit in the electrical power system, they shall respond and simultaneously trigger the safety system followed by rapid shut down of the turbine and bringing it into a safe condition.

11.5.9 Functionality of the control system and data storage

Suitable arrangement (e.g. watchdog) shall be available to detect the hang of the control system and/or data storage.

In addition, the control system shall be supervised by the control system itself on plausibility of functioning, and shall monitor whether the turbine follow the commands of the control system, i.e. among others, whether

- the communication between programmable logic control units in the hub and the nacelle necessary for the safe turbine operation is in place
- the stop procedure demanded by the control system is executed.

Rapid shut down of the tidal turbine performed by the safety system is required, if it is detected that the control system has lost control of the turbine.

If the safety system is triggered, the control system shall store the data of the final operating conditions.

11.5.10 Twisting of flexible cables

If operation of the tidal turbine may result in twisting of flexible cables, particularly the connecting cables and hoses between rotating parts (nacelle) and parts of the fixed structure (foundation), technical measures shall be taken to prevent destruction of these cables and hoses due to over twisting. Direction-dependent counting or a similar procedure for identifying the total revolutions of the nacelle shall be regarded as an appropriate measurement parameter for the monitoring of cable twisting in scope of control concept.

In the case of tidal turbines with active yaw systems, untwisting of the cables and hoses can be undertaken automatically by the control system through appropriate operation of the yaw drive. During the untwisting, the tidal turbine shall be gently shut down by the control system. After the flexible cables have been untwisted automatically, the turbine can be re-started automatically without clearance.

The maximum acceptable degree of twisting for the flexible cables and hoses shall be defined by the manufacturer or supplier and be monitored in the scope of the safety concept. This monitoring shall be independent of the measurements by the control system described above.

In case of exceedance of this safety-relevant limiting value the tidal turbine shall be brought into a safe condition by rapid turbine shut down performed by the safety system and by prevention of further nacelle rotation.

11.5.11 Functionality of essential machinery components

The functioning of essential machinery components shall be monitored within the control concept according to the state of the art. Such monitoring equipment (thermometers, pressure-gauges) shall cover physical parameters which can be used as a measure of reliable operation e.g. gear oil pressure, gear oil temperature, bearing temperatures, generator winding temperature etc. The extent to which such equipment shall be provided depends essentially on the overall design concept and the results of the risk assessment see [11.4].

Mechanical rotor brakes shall be monitored if it is required, see [11.4]. The brake lining thickness and / or the brake slack in the mechanical brakes, and also, depending on the design concept, the time to effect the braking or the power consumption, are factors that can be used as relevant measurement parameters for this monitoring. If the monitoring detects that the braking system is not ready for operation, the turbine shall be gently shut down by the control system. An automatic restart is not permissible.

If the monitoring of the mechanical torque is achieved by a friction clutch, the activation of this clutch shall be detected and in the event of that the turbine shall be shut down by the safety system.

If an auxiliary energy store (e.g. based on hydraulic accumulators, electric batteries or supercapacitors) is required, see [11.4], the charge status (actual energy content) of the energy store as well as temperature of the energy storages shall be constantly monitored by the control system.

11.5.12 Emergency stop buttons

Depending on the results of the risk analysis, see [1.10.3], emergency stop buttons may be required. In this case following requirements shall be considered.

Emergency stop function shall be part of the scope of the safety concept.



Triggering the emergency stop function must override all other functions and operations in all modes of the tidal turbine. Safety measures or other safety functions shall not be displaced or affected by the emergency stop function.

A complete stop of the rotor rotation upon emergency stop button activation may be required depending on the risk analysis results. The primary aim is not a gentle stop but rather the most rapid braking to a standstill that is compatible with the strength of the turbine. It may be necessary, after triggering of the emergency stop function, to allow further energizing and operation of

- equipment contributing the deceleration of rotor (stop category 1 as per IEC 60204-1, ISO 13850)
- auxiliary equipment, e.g. cooling, lubrication, navigation and collision warning.

De-energising of the medium- and the high-voltage systems may also be performed.

The requirements of ISO 13850, IEC 60204-1, IEC 60947-5-5 shall be observed for the design and location of emergency stop buttons. Disengagement of any emergency stop button following its use shall require an appropriate action. The misuse of the emergency stop buttons (for example, disabling within the maintenance, using for routine i.e. non-emergency operations) shall be avoided.

11.5.13 Leakage

If monitoring of the nacelle leak tightness is required by the design concept of the tidal turbine, the turbine shall be equipped with at least two leakage sensors (low and high level) installed on the bottom bilge of each non-flooded compartment. These sensors shall be parts of the control and safety systems, reaction of which on the leakage detection is defined in [11.8].

11.5.14 Collision warning

Since most parts of the tidal turbine structure will not be visible, installation of special lighting and marking, as well as transponders, implementation of a collision warning system can be required by local legislation. National and local regulations for lighting and collision prevention shall be observed. The necessity for the installation of signal lights, sound signalling devices for fog as well as other systems such as radar beacons, sonar or Automatic Identification System shall be considered. The status of these devices shall be monitored within the control concept.

11.6 Actuating mechanisms

11.6.1 Braking systems

The braking system is an actuating mechanism containing all components which on demand contribute towards braking the rotor, starting with the brake actuators (e.g. electric pitch drives, hydraulic cylinders) and ending with the brakes themselves (e.g. braking callipers, pads, blades, ailerons, dynamic braking resistors).

The braking system is engaged by the control or safety systems with targets defined in control and safety concepts, e.g.

- deceleration of the rotor and keeping the rotor speed below a maximum value
- bringing the rotor completely to a standstill from any operational condition
- regulation the power output or the rotational speed of tidal turbine.



A braking system may e.g. be of

- an hydrodynamic principle (rotor blades, ailerons)
- mechanical principle (mechanical rotor brake on low and / or high speed shaft)
- electrical principle (dynamic braking resistors; generator itself using power ramp down during shut down as well as short-circuiting during stand still).

At least one of the braking systems should operate on the hydrodynamic braking principle (e.g. based on active pitching or stall effect). If this requirement is not met, at least one of the braking systems shall act on the turbine parts rotating at rotor speed (hub, shaft).

If torque-limiting components are provided to limit torque, any mechanical brake shall be located between the torque-limiting device and the rotor hub.

The braking systems are of particular relevance with regards to safety. There shall be at least two mutually independent braking systems by means of which the rotor can be decelerated or brought to a standstill at any time. Depending on braking systems configuration (e.g. three blades with independent pitching; mechanical brake and blades with collective blade pitching, etc.) specific load case requirements are to be observed as per [5.6.3].

In the case of load shedding (e.g. grid loss) and simultaneous failure of one of the braking systems, the remaining braking system(s) must be able to keep the rotor speed below the maximum value.

As mechanical brakes are subject to a high degree of wear, the brake should as far as possible be operated on a low-wear or no-wear principle. Should the design of the braking system of the turbine permit the possibility of increased, unnoticed wear, requirements of [11.5.11] shall be observed. In the case of detection of mechanical brake wear the turbine shall be gently shut down by the control system with a consequent trigger of the safety system.

11.6.2 Yaw system

Yaw system is an actuating mechanism containing all components which on demand contribute towards rotation of the nacelle about the vertical foundation axis and positioning of the rotor such that the current hits the rotor plane at the right angle. Depending on the design concept of the tidal turbine it can include e.g.

- vane / fin / hydroplane for passive yawing;
- thruster and yaw clamp for changing and fixing nacelle orientation in accordance with tidal phase;
- electric or hydraulic yaw drives, yaw gearboxes and yaw braking pads for active nacelle yawing.

If control concept requires active yawing of the turbine, measurement of current direction shall be constantly carried out by the correspondent equipment, see [11.5.6].

Both active and passive yaw systems shall be provided with brakes or fixing arrangement.

Before starting, it shall be assured that the position of the nacelle conforms to the current direction sufficiently.

In case of a passive yaw system, it shall be established unequivocally before start-up that the position of the nacelle conforms to the current direction sufficiently.

11.6.3 Drain system

The drain system consists of bilge pumps, separators, filters and serves for draining due to condensation and leakage. Bilge pump(s) shall start-up automatically, if low level sensor detects leakage in the bilge. If a high liquid level is detected by the correspondent second sensor, the safety system shall shut down the turbine and de-energize all areas possibly affected by the leakage. The drain system shall be available within all operational modes.

Within the design of drain system, both water leakage and oil leakage shall be considered. Pumping of oily water out to the sea shall be prevented.

11.7 Auxiliary power supply for protection functions

To ensure safety of tidal turbine, following systems and equipment shall remain operable in the case of failure of the external power supply (e.g. electrical grid, external diesel generators):

- control and safety systems, if it is required by the control and/or safety concepts
- braking systems (with ability of keeping brakes open / readiness for at least one braking procedure)
- yaw system, if it is required by the control concept as regards structural integrity of the turbine
- drain system
- navigation lighting, collision warning equipment etc.

If this requirement can only be met if auxiliary power supply is provided (e.g. by means of any kind of energy storage - hydraulic accumulators, electric batteries), it shall be automatically monitored that a sufficient amount of energy is available.

If the automatic monitoring of the energy storage cannot be carried out continuously, then automatic tests shall be performed at least weekly to show that a sufficient amount of energy is available. The turbine shall be shut down immediately if the automatic monitoring or test yields a negative result.

For the definition of energy storage capacity, following aspects also shall be considered:

- power supply shall be available all the time at normal external conditions, see [4.8.12]
- grid disturbances are regarded as a normal external condition in the case if voltage and / or frequency deviations are within the range defined for normal external conditions;
- interruption of the external power supply (grid loss) with a duration of up to 6 hours is regarded as a normal external condition;
- grid loss with duration between 6 hours and 7 days shall be considered as extreme condition. If specific load cases in [5.6.3] require free rotation (trundle) of the rotor during this time, it shall be ensured that there is enough energy to keep mechanical brake open;
- if voltage and / or frequency deviations are out of range defined for normal external conditions, the control system decides whether a grid disturbance or a grid loss has occurred.

11.8 Remote control

The remote control comprises all hardware and software necessary to start, stop and command the yawing of a tidal turbine from a remote control room (e.g. in the coastal control facility).

The remote control facilitates:

- remote analysis and data collection from the turbines
- remote intervention / corrective actions in the case of any alarm transmitted from the control system of the tidal turbine
- preparation of the tidal turbine to retrieving operations
- avoidance of collision blade-tip / ship
- optimizing the parameterization

Actions available from the remote control room can include

- bringing the rotor to a free rotation by gentle shut down
- yawing the nacelle around the vertical axis
- engagement of the rotor or yaw lock, see [11.9]
- rapid shut down of the rotor.

Prior to any remote intervention it shall be ensured that the external conditions e.g. position of the nacelle to the current direction, are in compliance with the design assumptions.

11.9 Safeguarding

Safeguards in sense of this section are assemblies for the capture of materials, prevention of access, stabilisation of turbines parts position for the purpose of safety of persons within construction, transport, installation and maintenance works.

Tidal turbines shall be equipped with locking devices for stabilization of tidal turbine rotating parts – at least one lock or equivalent device each for rotor, yaw and blade pitching mechanisms.

Automatic engagement of locking devices is not necessary in general. Remote engagement / unlocking can be necessary for transport and installation operations.

Braking equipment may not, as a rule, be regarded as constituting the required locking device. Deviation from this rule is possible in exceptional cases, provided the system design ensures that work on the turbine including parts of the braking system can be carried out safely.

Work on a braking system can be carried out safely only if rotation of all parts which the braking system is intended to stop can be reliably prevented.

The locking devices shall be so designed that even with a brake removed they can reliably prevent any rotation of the rotor, nacelle or the rotor blade. The design of the locking devices shall be based on Section 10. Safe and reliable unlocking shall be ensured.

The rotor lock shall be arranged to act on the drive train near the hub, and shall have form-fit.

If it can be ensured that during the lifetime of the tidal turbine, the rotor locking device is applied only at conditions defined in load case DLC 6, see [5.6.3], the rotor lock can be dimensioned observing this load case only.



The design of the locking device shall be based on the assumption that people deliberately enter, remain in and work in a hazardous area with confidence in the functioning of the device. Particularly high requirements shall thus be imposed as regards the operational safety, quality and accessibility of the device, as well as its engagement with the parts of the tidal turbine being locked (e.g. rotor blades, hub and shaft).

In case of automatic / remote activation of locking devices, measures shall be applied to prevent unwanted or unintended (accidental) automatic or remote engagement / disengagement.

For personnel on the turbine, it shall be possible to deactivate automatic / remote operation of the locking devices before entering areas of risk. An appropriate note shall be inserted in the instructions.

If possible rotation of any part of the turbine can endanger personal (e.g. when approaching such part), the locking device shall always be activated in advance. It shall also be activated even if the tidal turbine is held stopped by the brake. An appropriate note shall be inserted in the instructions.

Means of escape, fall protection etc. shall be provided if necessary for any construction, maintenance or repair work.

11.10 Assessment documents

The following documentation shall be provided:

- Description of the tidal turbine (type designation, general layout, functional principles, behaviour of the tidal turbine during normal operation).
- Risk assessment as per [11.1].
- Description of the control concept (sequences of starting and stopping procedures, behaviour of the tidal turbine on detection of malfunctions by the control system). See also APPENDIX B – DIAGRAMMATIC PRESENTATION OF TIDAL TURBINES CONTROL AND SAFETY SYSTEMS.
- Description of the safety concept (behaviour of the tidal turbine following activation of the safety system, statement of the criteria for which the safety system is triggered, numerical values). See also APPENDIX B – DIAGRAMMATIC PRESENTATION OF TIDAL TURBINES CONTROL AND SAFETY SYSTEMS.
- Summary on the protection functions design. See example in APPENDIX C – SUMMARY ON THE PROTECTION FUNCTIONS DESIGN “TURBINE BEHAVIOUR ON EXCESSIVE CABLE TWIST” (EXAMPLE).
- Electrical and hydraulic (and, if applicable, also pneumatic) circuit diagrams at least to the extent that the protection functions in scope of safety concept are shown. In the circuit diagrams, the connections between the electrical and hydraulic (and, if applicable, also pneumatic) system shall be clearly recognizable. For hydraulic systems, please refer to [10.6], and for electrical diagrams to [12.1].
- Documentation of software used in the instrumentation of control and safety systems necessary for the implementation of the protection functions. Reference is made to ISO 13849-1 Section 4.6 and Annex J.
- Description of any inside and outside monitoring cameras and microphones if applicable.

- 
- Description of the procedure for clearance of the tidal turbine after activation of the safety system.
 - Description of the braking systems and their behaviour (structure of the braking systems, mode of operation, characteristic quantities, time constants, etc.).
 - Functional description of the locking devices.

12 ELECTRICAL SYSTEMS

12.1 Electrical systems

12.1.1 Area of Application

The provisions of this section apply to installations for the generation, distribution and transmission of electrical power and to electrical and electronic control equipment in horizontal axis tidal turbines (HATT).

Insofar as they are located inside the tidal turbine, Sections [12.1] through [12.9] shall be applied. In addition the power transformer, the medium-voltage switchgear and the frequency converter fall also within scope of assessment if they are installed:

- sub-sea - external to turbine
- shore-based
- on surface-piercing platform

Installations beyond the subsea output transmission cable of the tidal turbine (located on different foundations) belong to the area of application of [12.10].

Test requirements for generator, power transformer, frequency converter and medium-voltage switchgear are specified in [17.4] through [17.7].

12.1.2 Standards

All electrical equipment and individual components shall be designed in accordance with recognized standards, which shall be listed in the technical documentation.

Special attention should be paid to the protective measures, as listed in the IEC 60364 series.

In addition, IEC 60204-1:2005 and IEC 60204-11:2000 should also be applied.

In each case, the latest version shall be used. The publication dates cited below reflect the situation applicable at the time this standard was printed.

12.1.3 Operating and environmental conditions

All electrical components shall be designed to comply with the operating and environmental conditions expected at the installation site.

External environmental conditions are to be assumed as given according to Section 4. Internal temperature assumptions concerning locations with electrical installations (at least in the hub and at the frequency converter) shall be submitted for assessment.

Besides controlling of the climatic conditions, the coating of materials can also improve the withstand strength against the marine environment. For electrical installations, both should be taken into account:

- climatic condition control according to the measures given in [12.1.4], and
- coating systems or other corrosion protection according to Section 13.

12.1.4 Specification and testing of inside equipment

This section shall apply only for electrical equipment within scope of assessment and being part of the electrical power transmission (e.g. generator, frequency converter, transformer, medium-voltage switchgear, etc.).



The environmental conditions of the place of installation shall be specified according to IEC 60721-3-3:2002-10. For Design Assessment, the details of the testing procedure including success criteria and operation definitions shall be submitted.

It shall be proved for electrical equipment named in in this Section that it is able to withstand the specified conditions. This shall be done in applying environmental testing procedures as given in IEC 60068. The comprehensiveness of testing is defined in IEC TR 60721-4-3:2003.

The environmental testing can be omitted if the following applies:

- The climate inside is controlled, e.g. by means of a redundant air conditioning system and sufficient measures are provided during standstill or grid outages.
- Inside air temperature does not exceed 40°C due to secondary cooling systems of the main components.
- Humidity inside is kept below 95% during operation, and sufficient measures are provided during standstill or grid outages.
- A constant overpressure with conditioned air can be assured during operation and sufficient measures are provided during standstill or grid outages.

12.1.5 General Design requirements

12.1.5.1 Clearance and creepage distances

If not further specified in the following sections [12.212.10] through [12.10] the distances between live parts of different potential and between live parts and the cases of other earthed metal, whether across surfaces or in air, should be adequate for the working voltage, overvoltage category III, pollution degree 3, having regard for the nature of the insulating material and the conditions of service.

Guidance note:

Information regarding creepage and clearance distances is given in the specific equipment standards, referred to in IEC 61892-3.

---e-n-d---o-f---G-u-i-d-a-n-c-e---n-o-t-e---

12.1.5.2 Insulation

Insulating materials and insulated windings should be resistant to moisture, sea air and oil vapour, unless special precautions are taken to protect insulants against such agents.

Guidance note:

As a consequence of this clause, insulating materials in important applications, such as busbar supports etc., should have sufficient resistance against tracking. It is recommended that the comparative tracking index of such materials be not less than 175V when determined according to IEC 60112.

---e-n-d---o-f---G-u-i-d-a-n-c-e---n-o-t-e---

12.1.5.3 Lighting

In the question of lighting design requirements, IEC 61892-2:2012 sub clause 11 may be applied.

12.1.5.4 Alarm and communication

In case emergency broadcasting or alarm systems are to be implemented, IEC 61892-2:2012 sub clause 12.15 may be applied.

12.1.6 Parallel operation with public power supply networks

With regard to the grid quality expected for tidal turbine, reference is made to the assumptions in [4.8.12]. They may be detailed by the manufacturer of the tidal turbine when describing grid failure behaviour as required in Section 5.

Tidal turbines intended for parallel operation with public power supply networks require additional approval from the relevant grid operator. Part of this can be the corresponding Grid Code Compliance Certification (GCC). In general, the Grid Code of the relevant grid operators should be taken into account for this purpose. A list of Grid Codes can be found on the Internet at http://www.gi-group.com/pdf/IGCC_list.pdf. Some countries require Grid Code Compliance by law (e.g. Spain and Germany).

Power electronics shall be so designed that the harmonics generated do not affect the function of connected electrical equipment, the equipment does not suffer any damage, and no impermissible transients or harmonics occur during parallel operation with the grid.

The admissible limiting values should be agreed with the grid operator. As a guideline value, a permissible total harmonic distortion (THD) content of the current of 10% can be applied.

12.1.7 Assessment documents

The following documents are to be submitted for assessment. They are described in more detail in the corresponding sections and in the following sections.

12.1.7.1 General

Temperature assumptions according to [12.1.3].

Description of the air flow concept inside the hub and nacelle regarding the protection of electrical equipment against salty humid air from outside (during transportation, installation, maintenance) or inside (caused by leakages); see also [10.5].

Determination of the environmental classes used for specification of electrical equipment according to [12.1.4] where applicable.

Test certificates or a description and proof of evidence according to [12.1.4].

An overview diagram (formerly called "single line") as well as electrical schematics of the electrical systems of the tidal turbine according to IEC 61082 which should include data as required in [12.7.3] and [12.8.1]. If applicable, connections to the hydraulic circuit diagram shall be clearly recognizable in the electrical schematics.

Electrical overview diagram for the safety system with the SRP/CS (safety-related parts of control systems).

The following documentation is required for the assessment of electrical components:

- General functional descriptions of and maintenance instructions for electrical appliances.
- Parts list with the design data and manufacturer's information for all important electrical appliances, including the sensors and limit switches used.

12.1.7.2 Rotating electrical machines

Corresponding marking plates for the corresponding machines see [12.2.1] and [12.2.3].



Design data and calculations according to [10.2] for electrical pitch, [12.2.2], [12.2.3], [12.2.6], [12.2.7] and the voltage ratio between stator and rotor for generator.

Filter design and calculation documents according to [12.2.2].

Equivalent circuit diagram according to [12.2.2].

Measurement reports on tests, as defined in [12.2.2], [12.2.6] and [17.4].

maintenance instructions

Documents according to the given sections, where applicable, as specified in [12.2.2].

If draught-ventilated machines are used, documentation according to [12.2.5] shall be submitted for Design Assessment.

Generator bearing documentation according to [12.2.7] including:

- Static rating of generator bearings.
- Modified rating life as per ISO 281.
- Sectional drawings of the generator, indicating the installation position of the bearings and the rotor.
- Sectional drawings of the generator rotor, indicating the shaft dimensions, centre of gravity and moment of inertia of the generator rotor.

Description of earthing and slip ring brush monitoring.

12.1.7.3 Power transformers

According to [12.3.1] and [17.5], nameplate data and type test records of the transformer as per IEC 60076-1 (2000) are to be provided. For dry-type power transformers, see [12.3.4].

Description according to [12.3.1], [12.3.4] and [12.3.5].

Design and commissioning documentation according to [12.3.2], [12.3.3] and [12.3.4].

Description of the electrical insulation system of the transformer according to [12.3.4], where applicable.

12.1.7.4 Frequency converter

Statements of the frequency converter manufacturer according to [12.4.1], [12.4.2] and [12.4.8].

Material documentation according to [12.4.2].

test reports according to [17.6].

Calculations or measurements according to [12.4.3].

Descriptions according to [12.4.1], [12.4.2] and [12.4.3].

Manuals according to [12.4.7].

Documentation according to [10.2] if frequency converters are used within the blade pitching system.

12.1.7.5 Medium-voltage switchgear

Type test records according to [17.7].

Nameplate data according to [12.5.1].

Drawings and commissioning.

12.1.7.6 Back-up power supply systems

Descriptions according to [12.6.2] (charging equipment).

Calculations according to [12.6.3].

Manuals according to [12.6.3].

Data sheet of the back-up power supply system.

Power consumption schedule according to [12.6.5].

12.1.7.7 Low-voltage switchgear, control gear and switchboards

Test reports according to IEC 60364-6 shall be submitted as required in [12.7.1] and according to IEC 61439-1, as required in [12.7.17].

Calculations for busbar strength according to [12.7.20].

Calculation of short-circuit current for the main power transmission circuit between generator and medium-voltage switchgear according to [12.7.3] (e.g. for generator stator, generator rotor, frequency converter, transformer, circuit breakers and the power cables and busbars in between).

List of switching devices according to [12.7.3].

Description of electric arc detection according to [12.7.3].

Additional documentation according to [12.7.7].

12.1.7.8 Cables, lines and accessories

- The documents according to [12.8.3] are to be submitted.

12.1.7.9 Lightning protection

Descriptions or drawings concerning:

- Lightning protection zones and statement of the manufacturer according to [12.9.3].
- Bonding bars and bonding conductors with their cross-sectional areas.
- Diagram showing the SPDs and protection levels achieved by their installation (single-line).

Manufacturer's maintenance plan according to [12.9.3].

Data sheet for surge arresters according to [12.9.3].

Applicable for [12.9.3]:

- Description of the earthing system incl. details about the lightning protection of housings and / or surface-piercing platforms.
- Drawing of the earthing system.

12.1.7.10 Array cabling

If applicable, a subsea cable list. The list shall contain all cable details according to [12.10].

If applicable, a description of the subsea cable laying procedure, taking into account the issues described in [12.10.4] and containing the nautical charts of cable trays.

12.1.8 Stand-alone operation

In the absence of specific data, the guideline values given in Table 12-1 should be assumed for the operating conditions in stand-alone operation:

Table 12-1 Permissible voltage and frequency deviations in stand-alone operation

Parameter		Deviation	
		permanent	short-term
A	Frequency	± 5%	± 10% (5 s)
	Voltage	± 10%	± 20% (1.5 s)
B	Voltage	± 20%	
Notes: A: General B: Storage batteries and frequency converters			

For storage devices, [12.6] shall be applied as far as applicable.

Guidance note:

Deviations from this standard are permissible if the connected consumers are suitable for this. For DC charging generators, the voltage conditions for battery-charging operation apply.

---e-n-d---o-f---G-u-i-d-a-n-c-e---n-o-t-e---

It is strongly recommended that the load cases associated to grid loss are assumed, giving all details on different grid failure possibilities as symmetrical and unsymmetrical short circuit failures, frequency and voltage changes for both, current change and load change cases.

Measures for detection and control of the electrical grid frequency shall be implemented in isolated grids. These measures shall be in line with the assumptions made in this Section.

If further requirements are missing for the design, EN 50160 should be applied.

As a proof of the ability to run in isolated grids, the tidal turbine shall be operated for 100 hours during high and low current with variable and changing loads. The test is accepted if no protection has tripped and the tidal turbine has never transgressed the design values for grid frequency, voltage, power factor and current. Applicable parts of IEC 62124:2004 may be used if helpful. A corresponding report with data on current and load power shall be provided for assessment.

12.2 Electrical machines

12.2.1 General

Electrical machines in tidal turbines (generator, main / auxiliary electrical motors) shall on principle comply with IEC 60034. This shall be proven by corresponding statements of the electrical machine manufacturer on the rating plate.

All data on the rating plate shall be provided as required in IEC 60034-1:2010 sub clause 10.2. A corresponding rating plate shall be placed at each electrical machine.



Electrical machines shall be so designed and constructed that the permissible over-temperatures for the class of insulation are not exceeded, irrespective of the operating time. The values listed in IEC 60034-1:2010 shall be used as guideline values.

Electrical machines shall be so designed to withstand the highest speed according to Table 18 of IEC 60034-1:2010.

12.2.2 Rating of generators

Generators for tidal turbines should be designed for continuous operation (duty type S1 as per IEC 60034-1). Other duty types should be agreed upon in advance.

The power rating according to the generator rating plate may differ from the total tidal turbine rated power P_r as defined in [1.7.2]. This is acceptable, as long as the test reports of the generator tests show compliance with duty type S1 and insulation class as designed, as well as capacity of the generator to operate at P_r .

The generator shall be so designed to withstand the highest speed either according to Table 18 of IEC 60034-1:2010 based on the maximum rated speed of n_3 or with n_{max} as defined in [1.7.2], depending on which value is higher. Additionally the speed rating of the generator should take into account the frequency converter rating. The frequency converter system voltage and the level of the corresponding voltage testing depend on the maximum speed n_{max} , too. See also [12.4.2] for details.

The insulation system of the generator (e.g. rotor, bearings) must support voltage peaks. The maximum voltage change rate (dU/dt) shall be in compliance with the maximum value generated by the frequency converter system.

If the generator is used with frequency converter system, some method should be deployed to limit the bearing current and shaft voltage. This will come in the form of a combination of grounding system, converter filters and bearing insulation. Corresponding calculations and measurements of the shaft current and voltage shall be submitted for assessment, see [12.4.2]. The calculations should give the relation between shaft voltage and bearing current as well as shaft current measurements.

If the generator is used with frequency converter systems on the rotor side, the generator shall be equipped with slip rings for shaft earthing. The slip rings for shaft earthing should be installed at the NDE (non-drive end) or both sides of the generator rotor.

The equivalent circuit diagram, including the parameters of the generator, shall be submitted for Design Assessment (see APPENDIX E – GENERATOR PARAMETERS FOR ELECTRICAL CALCULATIONS AND SIMULATIONS).

If synchronous generators are equipped with devices or other measures for short circuit limitation, the resulting electromagnetic torques (M) should be analysed to show their function and efficiency. In this case, if a synchronous generator with separately excitation system is used, the parameters according to IEC 60034-16-3:1996 Figure 1 shall be submitted for assessment.

Guidance note:

For determination of the resulting electromagnetic torque (M), see GL Guideline for Certification of Offshore Wind Turbines 2012 Section 4, Appendix 4.C.

---e-n-d---o-f---G-u-i-d-a-n-c-e---n-o-t-e---



The balancing quality grade of the generator rotor (as per ISO 1940-1) shall be provided for the assessment.

12.2.3 Rating of auxiliary motors

Motors shall be designed according to the operating times and temperatures to be expected. The designed duty types should be given as specified in IEC 60034-1:2010 Part 1 or as per equivalent codes.

The nominal torque (M_n) and the equivalent torque (reference torque) of auxiliary motors (e.g. pitch motor) shall be in compliance with the corresponding load calculations.

For pitch motors, please refer to [10.2] additionally.

12.2.4 Materials

The materials for the construction of electrical machines should be suitable for the expected environmental conditions; particular attention should be paid to the corrosive effect of a marine atmosphere. Materials unsuitable for a marine atmosphere may be used if protected by adequate coating or cladding; see [12.1.3].

If plastics are used for casings, terminal boxes and fan wheels, materials suited for low temperature should be used.

12.2.5 Ventilation and cooling

Electrical machines for tidal turbines should preferably be designed in fully enclosed form. Machines with a power output exceeding 50 kW should be provided with drain holes to prevent the accumulation of condensed water.

Draught-ventilated machines may be used if the machine is designed to be resistant against incoming air with moisture, oil vapour and dust, or if the incoming air is free from such. Corresponding evidence shall be provided for assessment.

The cooling circuit of the generator shall be monitored in a suitable manner.

12.2.6 Windings

In conjunction with the protective devices provided, electrical machines shall be able to withstand the thermal and dynamic stresses to be anticipated in the event of short circuit. The generator manufacturer shall provide a measurement report of generator short-circuit testing or / and full load calculations including model description. For testing purposes, original protection devices are not required. The worst cases shall be tested; see GL Guideline for Certification of Offshore Wind Turbines 2012 Section 4, Appendix 4.C. The following result values shall be given as a minimum: short-circuit torque at generator shaft, short-circuit current at rotor and stator, winding temperatures during the short circuit, maximum short-circuit duration until mechanical deformation in the air gap or at the coil ends will result in stopping the machine by welding the air gap during failure operation.

For generators the winding temperature shall be monitored with regard to its limiting values. Thermistors or equivalent sensors should be used; thermal overcurrent relays with bimetallic elements are not suitable.

12.2.7 Bearings and couplings

The verification of the bearings shall take place in accordance with [10.4.2].

To avoid damage to bearings, it is essential to ensure that no harmful currents can flow between bearings and the shaft and that the coupling is of an insulated type. The bearing



current density J for the bearings of electrical machines shall be smaller than $0.1A/mm^2$. Corresponding calculations or measurements shall be provided for assessment.

The bearing temperature shall be monitored in a suitable manner. Thermistors or equivalent sensors should be used.

It is recommended that the generator bearings be tested both on the test rig and in the field.

It is recommended that tests on the test rig be part of the Design Assessment and be performed with regard for the tilt angle of the tidal turbine. Measurement of the bearing temperatures and vibration behaviour is advisable.

It is recommended that tests in the field be part of the Type Certification. Measurement of the bearing temperatures and vibration behaviour is advisable over the full range of tidal turbine operation.

Lubrication of the bearings should be effective under all operating conditions.

12.2.8 Generator testing

For generator testing please refer to [17.4].

12.2.9 Earthing

If generators having rated voltages above 1kV are used, ground bolts shall be installed, to be able to earth correctly during maintenance or repair. Minimum requirements are given in IEC 60204-11 sub clause 5.

12.2.10 Carbon brushes

The length of the slip ring carbon brushes of the generator should be monitored continuously.

Guidance note:

This can be achieved e.g. by a limit switch.

---e-n-d---o-f---G-u-i-d-a-n-c-e---N-o-t-e---

The brushes have to be exchanged before total wear.

12.2.11 Direct drive generator (low speed)

For low speed generators installed in direct-driven tidal turbines the requirements in [12.2.1] to [12.2.10] shall be applied. Additional test requirements are given in [17.4.3].

12.3 Power transformer

12.3.1 General

If power transformers with an apparent power greater than 100 kVA are installed within the tidal turbine or at one of the listed places of installations according to [12.1.1], they fall within the scope of the assessment and shall meet the requirements set out below.

Transformers shall comply with the latest version of the international standard series IEC 60076. For transformer testing please refer to [17.5].

Data and information given on the nameplate shall be in accordance with the requirements of IEC 60076. A corresponding nameplate shall be placed at each transformer.

When additional air-cooling with fans is provided, the transformer nameplate should display the nominal power rating both with and without fans.



Power transformers shall be so designed and constructed that the permissible over-temperatures for the thermal class are not exceeded, irrespective of the operating time. Depending on the tidal turbine design, the transformer might be operated at a frequency converter. The increased warming caused by the additional harmonics shall then be taken into account.

12.3.2 Installation

Power transformers should be installed in separate rooms which can be locked and which are accessible to authorized personnel only. The installation locations for power transformers should be well cooled. The access to the transformer room should only be possible with the power transformer disconnected and earthed on the MV side. An exception to this can be made for power transformers of encapsulated or insulated design (with cable connection terminals being integrated in this design), but this has to be approved in each individual case.

The fastening torque for cable connection terminals of power transformers shall be specified and included in the design and commissioning documentation; please also refer to [12.7.18].

Power transformers for tidal turbines may be exposed to a higher level of vibration compared to other locations. This should be considered for the design and installation of the transformer. Confirmation by the transformer manufacturer that the transformer is qualified for operation with tidal turbines shall be provided for certification.

Transformer accessories, e.g. external protection devices and monitoring equipment mounted on the transformer, should be made of environment- and corrosion-resistant materials, when exposed to salty air. This shall be verified by the corresponding data sheet.

Guidance note:

When installing tidal turbines with power transformers contained inside the tidal turbine, the relevant national regulations should be taken into account. Reference should be made to e.g. VDE 0101 in the case of Germany. However, this does not fall within the scope of assessment.

---e-n-d---o-f---G-u-i-d-a-n-c-e---n-o-t-e---

12.3.3 Protection

Power transformers shall be protected against short circuit and overload.

It should be possible to switch off power transformers on all sides. Installations should have facilities that allow a disconnection of this equipment on all sides if voltages can be applied on more than one side.

Power transformers shall be fitted with temperature monitoring.

Transformers shall be protected against transient overvoltage and electrical stress on the insulation.

12.3.4 Dry-type power transformer

In addition to the tests in [17.5] following test shall be performed for dry-type transformer:

- Lightning impulse test
- If the power transformer enclosure is not designed with a protection degree of IP 55 or higher, the transformer should pass the test E3 according to IEC 60076-16 with humidity of above 95% and water conductivity in the range between 3.6S/m to 4S/m.

12.3.5 Liquid-immersed power transformers

Liquid-immersed power transformers shall be provided with a collecting arrangement which permits the proper disposal of the liquid.

Liquid-immersed power transformers should be fitted with protection against the outgassing of the liquid.

The liquid temperature shall be monitored. An alarm should be actuated before the maximum permissible temperature is attained. When the temperature limit is reached, the transformer shall be disconnected.

The liquid filling level shall be monitored.

Guidance note:

Encapsulated, liquid immersed transformers can be affected by cycling pressure loading that might lead to tank leakages. This should be considered in the design.

---e-n-d---o-f---G-u-i-d-a-n-c-e---n-o-t-e---

12.4 Frequency converters

12.4.1 General

Frequency converters are power semiconductor converter systems (PSCSs) which are normally used in pairs, one being connected to the rotating electrical machine and one to the internal grid. Both are interconnected by a DC bus, backed by power capacitors. Correspondingly, a machine-side converter and a grid-side converter should be considered. Grid-side and machine-side converters can be designed as parallel modules or as one single module.

If frequency converters are installed in connection with the generator within the tidal turbine or at one of the listed places of installations according to [12.1.1], they fall within scope of the assessment.

Additionally they fall within the scope of the assessment if the frequency converters driving rotating electrical machines. In this case [12.4.8] is applicable.

Sections [12.4.1] to [12.4.7] apply for low-voltage main frequency converters with a rated system voltage not exceeding $1000V_{AC}$ or $1500 V_{DC}$ as defined in IEC 62477-1:2012 Edition 1.0. For medium-voltage frequency converters with voltages above $1000 V_{AC}$ or $1500 V_{DC}$, 17.10 shall be applied.

According to [17.10], the frequency converter or its control system may be applied for testing of the load-relevant control and safety system functions (LRF) in a hardware-in-the-loop environment.

12.4.1.1 Electromagnetic compatibility (EMC)

Power electronics shall be designed in accordance with the electromagnetic immunity requirements and requirements for electromagnetic emissions. The relevant EMC requirements are given in IEC 61800-3.

The manufacturer of the frequency converter shall evaluate the results, proving that the EMC requirements are fulfilled based on measurements of an accredited test lab, accredited according to DIN EN ISO IEC 17025 for IEC 61000-4-30 and IEC 61400-21. This statement and the measurement report shall be provided for assessment.

Based on the test results concerning EMC, the manufacturer of the frequency converter should require corresponding measures that have to be observed during installation or assembly. At a minimum, the shielding of connecting cables should be defined in detail by the frequency converter manufacturer. This is verified in the witnessing of the Implementation of design-related requirements in Production and Erection (IPE).

12.4.2 General design and data to be provided

Protective earthing shall be designed according to IEC 62477-1 sub clause 4.4.4.3. Assessment shall be performed using a confirmation of this by the frequency converter manufacturer. This will be verified in the IPE at the frequency converter manufacturer's workshop. Minimum requirements are given in IEC 62477-1 sub clause 4.4.3.4.

Protective bonding shall be designed according to IEC 62477-1 sub clause 4.4.4.2 and tested by the frequency converter manufacturer according to sub clause 5.2.3.11. Assessment will be done based on corresponding test reports during Design Assessment. The implementation shall be checked during IPE at the frequency converter manufacturer's workshop.

The design concerning the connections between frequency converter and tidal turbine, as defined in IEC 62477-1 sub clause 6.3.6 (power conductor type, size, amount of cables etc.), shall be provided by the frequency converter manufacturer for assessment. The implementation will be inspected during the IPE at the tidal turbine manufacturer's workshop.

The frequency converter manufacturer shall state the pollution degree for which the frequency converter has been designed.

Table 12-2 Definitions of pollution degree

<i>Pollution degree</i>	<i>Description</i>
1	No pollution or only dry, non-conductive pollution occurs. The pollution has no influence.
2	Normally, only non-conductive pollution occurs. Occasionally, however, a temporary conductivity caused by condensation is to be expected.
3	Conductive pollution or dry non-conductive pollution occurs which becomes conductive due to condensation which is to be expected.
4	The pollution generates persistent conductivity caused, for example by conductive dust or rain or snow.

Statement and definition of environmental conditions shall be given according to IEC 60721. Guidance and minimum scope of documentation can be found in IEC 62477-1 sub clause 4.9.

The current flowing through generator bearings and generator shaft shall be analysed and possible paths shall be described. This analysis shall consider the measured shaft current and touch current from the converter, to be measured during the joint heat-run type test of the generator and frequency converter, see [17.4] and [17.6].

The maximum value of voltage steepness (dU/dt) shall be given and verified by measurement; see [17.6].

The distance between terminals of main power flow and any obstruction toward which the wire is directed upon leaving the terminal should be at least that specified in Table 12-3, with compliance to be checked by the IPE.

Table 12-3 Wire bending space from terminals to enclosure

Size of wire mm ²	Minimum bending space, terminal to enclosure mm		
	Wires per terminal		
	1	2	3
10 – 16	40	-	-
25	50	-	-
35	65	-	-
50	125	125	180
70	150	150	190
95	180	180	205
120	205	205	230
150	255	255	280
185	305	305	330
240	305	305	380
300	355	405	455
350	355	405	510
400	455	485	560
450	455	485	610

12.4.2.1 Insulation design

Insulation design shall be rated according to IEC 62477-1. For this, the impulse withstand voltage and temporary overvoltage shall be defined and tested for main power circuits. The impulse withstand voltage and the temporary overvoltage shall be determined according to Table 10 in IEC 62477-1 sub clause 4.4.7.1.5. For this, the system voltage has to be defined.

The system voltage of the machine-side converter shall not be less than the rms value of the maximum voltage phase-to-earth at one of the following operational points whichever is the most severe:

- At the highest possible speed n_{max} with disconnected grid side converter (with n_{max} according to [1.7.2]).
- at minimum speed occurring with the generator being connected at currents above v_{in} (with v_{in} according to [1.7.2]).
- at maximum voltage at the highest possible electrical power P_A (with P_A according to [1.7.2])

The system voltage of the grid-side converter shall be determined by the manufacturer of the frequency converter according to IEC 62477-1 sub clause 4.4.7.1.6.1 and provided for Design Assessment.

The overvoltage category according to IEC 62477-1 shall be OVC III for the machine-side converter and OVC III for the grid-side converter, provided the main frequency converter is installed in LPZ 1 or better.

Clearance distances shall be designed according to IEC 62477-1 sub clause 4.4.7.4, creepage distances according to IEC 62477-1 sub clause 4.4.7.5. This shall be documented by a corresponding statement containing the following information:

- CTI (comparative tracking index) according to IEC 62477-1 sub clause 4.4.7.5.1 of and IEC 60112:2009 (ed. 4.1) for all parts of the main power circuit inside the frequency converter
- pollution degree according to Table 12-2.



For the high-power circuits, busbars and coils, solid insulation material shall be used which has a proven performance according to IEC 62477-1 sub clause 4.4.7.8. The corresponding documentation shall be submitted for Design Assessment and inspection at the IPE.

In the case of plugs or similar devices that can be disconnected without the use of a tool, and in case their withdrawal results in the exposure of conductors (e.g. pins), the discharge time should not exceed 1s, otherwise such conductors should be protected against direct contact as per IPXXB at least. If neither a discharge time of 1 s nor a protection of at least IPXXB can be achieved, disconnecting devices with an appropriate warning should be applied instead.

12.4.2.2 Cooling

The cooling principle shall be described and provided for Design Assessment.

Cooling shall comply with IEC 62477-1 sub clause 4.7.2.2.

The cooling circuit of the converter shall be monitored in a suitable manner.

When the coolant is intentionally in contact with live parts (for example non-earthed heat sinks), the conductivity of the coolant shall be continuously monitored and controlled, in order to avoid hazardous current flow through the coolant.

If a DC chopper is used to convert excess energy to heat (e.g. to reduce mechanical loads), the design shall be described for Design Assessment. At a minimum, the following details should be given: maximum power and maximum operation time at full power, resistance range to be set, cooling time after full-power maximum-time operation, and cooling principle. All trigger values and trigger situations shall be given.

The following data shall be provided for Design Assessment of both the machine-side converter and the grid-side converter:

- name and address of the frequency converter manufacturer
- type of the frequency converter (e.g. IGBT 4-quadrant operation)
- designation of frequency converter (e.g. Converter 57HXY)
- generator manufacturer's name and address
- generator type (e.g. doubly fed induction generator)
- generator designation (e.g. Generator ABM6H)
- generator power rating
- details of filters necessary
- number of units connected in parallel
- rated apparent power per module
- rated maximum frequency
- rated minimum frequency
- rated current per module at maximum frequency
- rated current per module at minimum frequency

- maximum and minimum prospective short-circuit current rating of the machine-side converter AC input port and the grid-side converter AC input port according to IEC 62477-1 sub clause 4.3.2.2
- rated voltage or range at maximum frequency
- rated voltage or range at minimum frequency
- maximum voltage of the DC bus
- technical data of the DC bus capacitors (data sheet)
- crowbar and chopper resistance, if applicable
- cooler manufacturer
- cooling type
- rated thermal power of the cooler
- rated electrical power of the cooling system (fans, pumps etc.).

12.4.3 Protection equipment

All power electronics shall be protected against overload and short circuit. It shall not be possible for a semiconductor element to be destroyed in the event of a single malfunction outside the element itself. Protection of the installation may be achieved by fuses, circuit breakers or the intervention of the control system.

Single-phase protection equipment is not acceptable for three-phase installations. Exceptions can be made if other mechanisms ensure that three-phase tripping takes place, even in the case of one-phase faults. If fuses are used, a corresponding mechanism should be implemented.

The protection equipment shall ensure that, in the event of a disconnection, the energy stored in the components and the load circuit cannot have a damaging effect and that, in the event of a failure of essential components, the tidal turbine is brought to a standstill in a controlled manner and damaged subsystems are switched off as selectively as possible.

Self-test facilities are required for voltage loss, overvoltage and overcurrent protection equipment as well as for communication failure, to safeguard the function of the protection equipment.

Section [12.7] shall apply as far as it is relevant.

The principles used to fulfil the requirements for protection shall be described. This description shall be submitted by the frequency converter manufacturer. It shall be assessed during Design Assessment and implementation shall be verified during the IPE.

12.4.3.1 Crowbar

If a crowbar is used for protecting the frequency converter against excessive currents or voltages in the generator rotor, the design shall be described for Design Assessment. At a minimum, the trigger values, resistance and maximum operation time shall be given, as well as minimum cooling time after maximum operation time.

Guidance note:

For load cases considering grid loss that are considered adequate, measurements shall be carried out on the tidal turbine level to verify these load calculations.

---e-n-d---o-f---G-u-i-d-a-n-c-e---n-o-t-e---

12.4.4 Capacitors

Capacitors located behind panels that are removable for servicing, installation or disconnection shall present no risk of electric energy hazard from charge stored on capacitors after disconnection of the frequency converter. They shall be discharged to a voltage less than DVC A (given in IEC 62477-1 Table 5) and to an energy level of less than 20J, as set out in IEC 62477-1 sub clause 4.5.1.2, within 5s after the removal of power from the frequency converter. If these requirements are not achievable for functional or other reasons, the warning symbol ISO 7010-W001 (see IEC 62477-1 Annex C) and an indication of the discharge time (e.g. 45s, 5min) shall be placed in a clearly visible position on the enclosure, the capacitor protective barrier or at a point close to the capacitor(s) concerned (depending on the construction). The symbol shall be explained and the time required for the capacitors to discharge after the removal of power from the frequency converter shall be stated in the manuals.

Guidance note:

Additionally to the warning symbol ISO 7010-W001 converters can be equipped with display or lamps that indicate when the capacitors are discharged.

---e-n-d---o-f---G-u-i-d-a-n-c-e---n-o-t-e---

Conformity is checked when inspecting the frequency converter and relevant circuit diagrams, taking into account the possibility of disconnection with any ON / OFF switch in either position and no operation of periodic power-consuming devices or components within the frequency converter or supervisory control.

The corresponding calculation of the discharge time shall be submitted for Design Assessment.

If the capacitor discharge time cannot be accurately calculated, the discharge time shall be measured by an accredited laboratory and the report shall be submitted for Design Assessment.

12.4.5 Routine testing

For routine testing of the frequency converter please refer to [17.6].

The routine tests of the frequency converter shall be witnessed during the IPE.

The routine test report of one sample frequency converter (the type under assessment or a similar type) shall be provided for Design Assessment; working instructions shall be provided and will be inspected during the IPE at the frequency converter production factory.

12.4.6 Type testing

For type testing of the frequency converter please refer to [17.6].

12.4.7 Installation, commissioning and maintenance

Manuals shall contain at a minimum the requirement of IEC 62477-1 sub clause 6.3.8 for commissioning and sub clause 6.5 for maintenance.

The marking and scope of data to be given on the rating plate and in the manuals shall be in accordance with IEC 62477-1 sub clause 6.

12.4.8 Frequency converters connected to other systems than generator

This subsection shall be used for all applications of frequency converters in the tidal turbine, except the main power generator system.

For frequency converters driving rotating electrical machines supplied by DC voltages, the rating plate and corresponding specifications shall be given according to IEC 61800-1 sub clause 8 (product information) plus the maximum voltage change rate dU/dt in $kV/\mu s$.

It shall be verified that the specifications according to [12.2.3] match the corresponding components to which the frequency converter is connected.

For frequency converters driving rotating electrical machines supplied by AC voltages, the rating plate and corresponding specifications shall be given according to IEC 61800-2 sub clause 8 (product information), plus the maximum voltage change rate dU/dt in $kV/\mu s$.

For PSCSs being used for rotor blade pitching, please refer to [10.2] additionally.

The requirements in [12.4.1] apply.

12.5 Medium-voltage switchgear

12.5.1 General

If medium-voltage switchgears are installed within the tidal turbine or at one of the listed places of installations according to [12.1.1], they fall within the scope of the assessment and shall meet the requirements set out below

For type testing of the medium-voltage switchgear please refer to [17.7].

Information on the nameplate shall be in accordance with IEC 62271. A corresponding nameplate shall be placed at each switchgear.

12.5.2 Protective measures and tests

A risk of personal injury through electrical shock and internal arcs shall be minimized, independently of the necessary protection against foreign matter and water.

With reference to IEC 62271, only IAC (Internal arc classification)-qualified medium-voltage switchgear shall be installed. The test current applied shall be as high as the rated short-time withstand current of the respective type of switchgear used.

Installation of the switchgear shall be in accordance with the IAC accessibility type of the switchgear used.

Exceptions can be made:

- For switchgear installed in separate incombustible room that can be locked. Access to the room shall be granted only when the tidal turbine is switched off.
- If access into the turbine is only allowed / possible when the medium-voltage switchgear is de-energized.

12.5.3 Pressure relief

If the gas pressure resulting from internal arcs within the switchboard is to be vented via pressure-release flaps, the installation space shall be as specified by the switchgear manufacturer and should have an adequate volume. Suitable measures should be taken to



ensure that the overpressure occurring within the space is limited to physiologically acceptable limits. This overpressure should be taken into account for the structural design of the installation space.

If the switchgear is designed so that the gas pressure caused by internal arcs is also, or only, released downwards, the floor shall be constructed so that it can withstand this pressure. Care should be taken to ensure that sufficient volumes of space are available below the floor for the expansion of the internal-arc gases.

Combustible materials and low-voltage cables are not admissible in the endangered area.

Suitable drawings and commissioning manuals shall be provided for verification of an appropriate installation.

12.5.4 SF6 switchgear

SF6 switchgear shall only be installed in spaces which are adequately ventilated. This might conflict with an overall sealing of the nacelle. In this case, adequate monitoring of the SF6 pressure and short-circuit would be a solution. The design and specific solutions shall generally exclude the risk of hazards to service personnel and will therefore be assessed in each individual case.

Guidance note:

It should be taken into account that SF6 is heavier than air and the gases escaping in the event of internal arcing have toxic and corrosive effects. Reference is made to national requirements, for Germany e.g. BGV A8 and BGI 753 by BGFE (Berufsgenossenschaft der Feinmechanik und Elektrotechnik). However, this does not fall within the scope of assessment.

---e-n-d---o-f---G-u-i-d-a-n-c-e---n-o-t-e---

12.6 Back-up power supply system

12.6.1 General

This section considers electrical back-up power supply systems as a functional unit comprising charging equipment and energy storage systems. It applies to back-up power supply systems installed as an independent source of electrical power for safety systems, emergency consumers and systems which are necessary to regulate the climatic conditions inside of the tidal turbine.

Back-up power supply systems within the scope of this section shall be designed to cover failures of the internal or external power supply, as described e.g. in [11.7] and for situations related to grid loss in general.

12.6.2 Charging equipment

Only automatic chargers with charging characteristics adapted to the type of energy storage system, such as special battery types etc., should be used. Corresponding descriptions shall be submitted for assessment.

Overcharging should be prevented by automatic charger regulation or, if necessary, by dump loads which can be switched on. Corresponding descriptions shall be submitted for assessment.

If consumers are supplied while charging is in progress, the maximum charging voltage should not exceed 120% of the rated voltage of the battery, not even during boost charging. Charging



voltage of the automatic charger shall be given in the description to be submitted for assessment.

Charging equipment shall have its own short-circuit and overcurrent protection equipment on both the input and the output side.

12.6.3 Energy storage system

For rating of the energy storage system of back-up power supply systems, the internal environmental conditions to be provided according to [12.1.3] and the assumptions made for load case definition according to Section 5 shall be taken into account.

For rating the energy storage system of back-up power supply systems intended for braking systems, reference is made to [11.7].

For rating the energy storage system of back-up power supply systems intended for controlling the climate inside the tidal turbine, reference is made to [12.6.5].

The sufficient rating of the energy storage system of a back-up power supply system shall be proven on the basis of calculations. All design limits, such as maximum load current, temperature limits, discharge limits etc., shall be stated in the calculations and provided for assessment.

Batteries, capacitor banks or other technologies used for energy storage systems should permit an adequate number of charge / discharge cycles. The design lifetime, including assumptions and calculations, shall be provided for assessment. Exchange intervals shall be defined in the tidal turbine manuals.

Warning signs indicating DC voltages higher than 60V and risks caused by batteries, if applicable, shall be provided on the enclosure of the energy storage system.

12.6.4 Installation and operation of batteries

To avoid sparking, circuits should be switched off before batteries are connected or disconnected.

Batteries mounted in the hub shall be suitable for the special requirements resulting from the rotating movements.

Enclosures for back-up power supply systems shall be resistant against corrosion due to the salty and humid sea air, shall provide a minimum protection class of IP 54 and shall be well-ventilated if they contain batteries and if there is a risk of outgassing.

Back-up power supply systems shall be installed in such a way that they are accessible for maintenance work.

The energy capacity and the correct functioning of back-up power supply systems shall be monitored. If they are used for braking systems, refer to [11.7].

If capacitor banks are used for energy storage systems, the partial voltages of capacitor groups should be monitored instead of monitoring the overall voltage of the capacitor bank. No charging should take place during monitoring.

12.6.5 Backup power supply for long periods

If a back-up power supply is chosen according to [11.7], information according to the requirements as given in this section shall be provided.



If a system is necessary to regulate the climatic conditions inside of the tidal turbine according to [12.1.4] measures shall be taken to keep the corresponding climate in the tidal turbine during a grid outage for 3 months. Corresponding information shall be provided.

The power supply should be dimensioned in such a way, that it will be able supplying the necessary starting or inrush currents and the energy consumption needed. This shall be documented in a power consumption schedule, see [12.1.7]. If necessary a power consumption management should be made to achieve the requirements. The simultaneous power consumption according to this management shall be stated in the power consumption schedule.

The energy storage of the back-up power supply has to fit properly on site.

The size of the energy storage shall be dimensioned in order to achieve the requirements as given in this section in conjunction with the concept chosen in [11.7].

The assessment documents shall contain the size of the storage and the energy consumption calculations of the chosen back-up power supply.

The energy level (content of the energy storage) has to be monitored and alarm levels have to be defined.

Guidance note:

To prevent damage in the gear during grid unavailability and no remote-operated rotor lock, the energy needed for fixation fast shaft brake operation and control should be taken into account.

---e-n-d---o-f---G-u-i-d-a-n-c-e---n-o-t-e---

12.7 Low-voltage switchgear, controlgear and switchboards

12.7.1 General

The requirements of this section apply to low-voltage switchgear and controlgear assemblies with operating voltages of up to 1000 V_{AC} or 1500 V_{DC}.

Stationary or movable switchboards with or without enclosure including the integrated mechanical and electrical components shall comply with the standard IEC 61439-1.

All components of the electrical installation shall be protected against overload and short circuit.

All appliances, instruments and operating elements (e.g. sensors, limit switches) shall be permanently labelled in accordance with the corresponding circuit diagrams.

Upon completion of the verification of installation, an initial report according to IEC 60364-6 shall be provided.

12.7.2 Protection – general

Overload and short-circuit protection shall be provided for each line conductor.

12.7.3 Short-circuit and electric arc protection

The rated breaking capacity of each circuit breaker used for short-circuit protection shall not be less than the maximum possible short-circuit current at the point of installation.

Short-circuit current calculations shall be carried out for the main circuit. The short-circuit calculation shall consider all possible short circuits necessary for an evaluation of the system. The following types of short circuits shall be investigated at least for:

- short circuits on the rotor and stator terminals of the generator (except for permanent magnet rotors)
- short circuits on main busbars

All data used for the short-circuit current calculation shall be submitted.

The following values shall be determined according EN 60909:

- peak short-circuit current i_p
- initial symmetrical short-circuit current (I_k'')

The short-circuit current calculation should be accompanied by a list of the proposed switching devices and their characteristic data. The rated making capacity, the rated breaking capacity and the utilization category of the switching appliances shall be stated.

Electric arc detection in combination with electrical value detection is recommended.

12.7.4 Overload protection

The selection of overload protection devices shall be based on the rated currents in the cable or circuit.

12.7.5 Overcurrent protection

The current-time characteristics of overcurrent protection devices shall be compatible with the system components to be protected and with the requirements of selectivity.

The overcurrent protection of the entire circuit (switchgear, switchboard wiring, supply cables and equipment) shall be based on the rated current I_n of the connected equipment. In the case of grouped supply cables, the protection design shall be based on the evaluated total rated current.

12.7.6 Selectivity

The short-circuit protection of essential equipment shall be selective and shall ensure that only the switching device nearest to the fault initiates disconnection of the defective circuit.

12.7.7 Residual current

Residual current protective devices (RCDs) shall be provided for socket-outlets for maintenance purposes with a rated current up to 32A.

12.7.8 Switching devices – general

The making and breaking capacity of switchgear shall be stated by the manufacturer and entered into the assessment documentation.

The rated current values of fuses shall be stated. The set values of the adjustable protection equipment shall be stated in the circuit diagrams and permanently marked on the device.

Switches and circuit breakers in three-phase circuits shall disconnect all phases simultaneously.

12.7.9 Switches

Switches should be rated for at least the rated current of the back-up fuse.

12.7.10 Circuit breakers

The rated making capacity of a circuit breaker should not be less than the maximum asymmetric short-circuit current which may occur at the point of installation.



The set points of adjustable protection devices should be permanently marked either on the scales or on plates fixed nearby.

In the case of a fault in the circuit breaker on the low-voltage side of the power transformer, the medium-voltage switchgear shall trip.

Circuit breaker shall comply with one of the following standards:

- IEC 60947 for low voltage equipment
- IEC 62271 for high voltage equipment

Circuit breakers the making / breaking capacities of which are less than the anticipated maximum short-circuit currents shall be protected by back-up fuses of sufficient breaking capacity.

12.7.11 Fuses

Fuse links should have an enclosed fusion space.

Fuses for overload protection should be used only up to a rated current of 315A.

Fuses shall normally comply with one of the following standards:

- IEC 60269 for low voltage fuses
- IEC 60282-1 for high voltage fuses

12.7.12 Motor-circuit switches

Motors with a power rating of more than 1 kW shall be individually protected against overloads and short circuits.

Regardless of its rating, every motor shall be protected by a suitable short-circuit protection device.

12.7.13 Distribution panels – general

Electrical components mounted in the doors of switchboards for voltages over 50V shall be safeguarded against accidental contact. Such doors shall be earthed.

Electric equipment and fuses should be safely accessible.

For circuit breakers and load-switches, the minimum distances above the arc chutes specified by the manufacturers should be kept free.

12.7.14 Protection class of distribution panels

The degree of protection of an enclosed assembly installed inside the tidal turbine against contact with live parts and water should be at least IP22 according to IEC 60529 and if the compartment where the panels are located is watertight. This shall be assessed during witnessing of the commissioning.

The degree of protection of outside equipment shall be IP68 according to IEC 60529.

Unless specified otherwise, the degree of protection indicated by the manufacturer applies to the complete assembly when installed in accordance with the manufacturer's instructions, for example sealing of the open mounting surface of an assembly, if necessary.

12.7.15 Corrosion protection of distribution panels

In order to insure effective corrosion protection of steel structures, every low-voltage switchgear, controlgear and switchboard shall be protected by paint coatings according to [12.1.3].

For further requirements for corrosion protection, see Section 13.

12.7.16 Climate of distribution panels

During operation, the air temperature in enclosed switchboards should not exceed +45°C and should not fall below -5°C, otherwise all components should be verified concerning their operation conditions.

For details, also about the applicable withstand temperatures when switched off, see [4.8.3].

12.7.17 Tests of distribution panels

To verify the characteristics of a switchboard, type tests shall be performed according to IEC 61439-1. The measurements should be performed by personnel from a quality department that are independent of the production or design team. The test reports shall be submitted for assessment.

12.7.18 Terminal bars

All screws and other connections shall be safeguarded against mechanical stress by vibration. Small screws up to M4 may be locked using varnish.

To prevent conductors being squeezed off, terminals shall have backing plates or the conductors shall be fitted with protective sleeves or equivalent protection for the wires.

Protective earthing shall be provided by means of earth terminals or earth bars. Earth terminals shall be clearly marked as such.

Screws carrying electrical current shall be marked to indicate that proper torque was applied.

Live parts that are under voltage after the main circuit breaker has been switched off shall be insulated and marked with a warning plate at the terminals.

12.7.19 Conductors in panels

All conductors shall be fixed so that they are vibration-proof and shall be kept away from sharp edges.

Conductors leading to equipment mounted in doors shall be laid in a tension-free manner.

12.7.20 Busbars

Busbars shall be mounted in such a way that they withstand the stresses caused by short-circuit currents and foreseeable mechanical forces defined in the load cases, see Section 5 and maintain the required clearance and creepage distances relative to other voltage-carrying or earthed components. Calculations or tests shall be provided for assessment.

12.7.21 Control, measuring and indicating circuits

Control circuits shall generally be equipped with separate short-circuit protection up to a maximum of 10 A. Joint fuse protection of control and load circuits is permissible if the joint back-up fuse has a maximum rating of 10A.

Measuring and indicating devices shall generally be provided with their own circuits, to be protected by separate fuses against short circuits.

12.8 Cables, lines and accessories

12.8.1 General

Cables, lines and accessories should be selected in accordance with the environmental conditions expected at the installation site.

Cables, lines and accessories installed in the tidal turbine outside of enclosures shall be resistant to operating fluids such as oil and grease.

The rated voltage of cables, lines and accessories shall not be below the rated operating voltage of the circuit involved. For circuits with variable voltage, the maximum voltage occurring during operation is decisive.

The technical documentation shall state the cables and lines used, together with their standard designation and current-carrying capacities. Furthermore, the conductor cross-sections and voltages shall be entered in the schematics. This shall be done for all high-power and safety circuits as required in [12.1.7].

Multi-core cables or lines should preferably be used for AC systems. If single-core cabling is provided instead, the following points shall be observed:

- The cables shall not be armoured with or sheathed in magnetic material.
- Non-magnetic clamps shall be provided.
- The cables of a given circuit shall be laid contiguously and shall be arranged in the same tube or cable duct.

Single-core parallel cables shall be of the same type, length and cross-section.

12.8.2 Selection of cables, lines and accessories

Cables, lines and accessories relating to the main power transmission circuit shall comply with the IEC publications listed in this section. These standards shall be applied by the cable manufacturer, who shall state corresponding compliance on his data sheet. Other cables or lines may be used if their material and construction complies with equivalent standards (e.g. German VDE) and if verification of their suitability for the application is provided.

- Low-voltage installations:
 - IEC 60227 "Polyvinyl chloride insulated cables of rated voltages up to and including 450/750 V".
 - IEC 60228 "Conductors of insulated cables".
- Medium-voltage installations:
 - IEC 60502 "Power cables with extruded insulation and their accessories for rated voltages from 1 kV ($U_m = 1.2$ kV) up to 30 kV ($U_m = 36$ kV)".
- High-voltage installations:
 - IEC 60840 "Power cables with extruded insulation and their accessories for rated voltages above 30 kV ($U_m = 36$ kV) up to 150 kV ($U_m = 170$ kV) – Test methods and requirements".

12.8.3 Documents to be submitted for Design Assessment

- Torsion resistance test log or report for those lines connecting rotating parts (nacelle) with parts of the fixed structure (tower, tripod, monopile or comparable).
- Proof of oil resistance based on a declaration or certificates or test reports (e.g. based on IEC 60502) of the manufacturer for those types of cables, lines and accessories likely to be exposed to contamination with operating fluids.
- Proof of the current-carrying capacity of main power cables, with consideration of the laying method and installation. Proof can be provided by applying the standard IEC 60287 or IEC 60364-5-52. An installation or routing plan of main power cables including routing and indication of attachment points shall be provided, too. Worst-case operating conditions, such as the minimum tolerable operating voltage and maximum capacitive power factor, should also be considered for the determination of sufficient current-carrying capacity of main power cables and lines.
- data sheets according to [12.8.2].

12.8.4 Loading and protection of cables and lines

Cables and lines shall be protected against short circuit and overcurrent ([12.7.3] to [12.7.5] shall be applied analogously). If overcurrent protection is already provided in the circuit for the equipment, short-circuit protection should be added. This shall be designed in accordance with the short-circuit loads at the point of installation.

For the rating of cables and lines, consideration should be given to the loads expected during operation corresponding to the consumer demand, taking into account the duty of the electrical units connected. Values on the rating plates of generators and consumers should be considered as a basis.

For cables and lines subjected to twisting during operation, a control device shall be provided which protects against exceeding permissible limits. In terms of its operation, the installation should be so designed that resetting to the neutral position is possible, see [11.5].

12.8.5 Installation of cables and lines

Cables and lines shall be secured in such a manner that no unacceptable tensile, flexural, compressive or crushing stresses arise. Extraordinary mechanical demands, such as increased tensile or torsion stress, operationally required mobility and increased risk of mechanical damage, shall also be taken into account.

For cables suspended freely without additional strain relief, the suitability of the type of cable used shall be verified. Suspended cables shall be properly protected against damage and unacceptable constriction of the cable sheath.

Where there is a risk of mechanical damage, cables and lines shall be effectively protected by coverings or heat shrinks, protection tubes or equivalent.

If cables or lines are laid in metal tubes or ducts, these shall be earthed effectively. Warming of such cables should be considered during design stage and selection, see [12.8.3]. The tubes should be smooth on the inside and so protected at the ends that there is no risk of damage to the cable sheathing.

The minimum specified bending radius of cables shall be observed for installation.

12.8.6 Risers

The installed cables within risers (main power transmission circuit, auxiliary supply, remote monitoring) shall be sea water-resistant. The requirements given in [12.8.1] to [12.8.4] should be applied as far as applicable.

For power cables with rated voltages above 1kV the requirements in [12.10] shall be applied as far as applicable.

For the connection / disconnection system of cables installed within the riser watertight connectors shall be used. The connection / disconnection system shall be strain-relieved to avoid the occurring forces on the cables.

Documents to be submitted for Design Assessment:

- Overview drawing of the cable installation within the riser including the connection / disconnection system
- Data sheets of the installed cable types and connectors

12.9 Lightning protection

12.9.1 General

The lightning protection system shall comply with the international standard series IEC 62305 insofar as this section does not deviate from the IEC documents. This will be assessed at a minimum with respect to the requirements given in this section. National requirements in excess thereof and any additional requirements of the grid operators should be observed but cannot be assessed during Type Certification.

Any measurements should be performed by personnel from a quality department that are independent of the production or design team.

12.9.2 Lightning protection level (LPL)

Determination of LPL is necessary only for outer parts of the tidal turbine or for components connected to the tidal turbine (e.g. signals for shipping) which are above water surface and therefore endangered by lightning. Determination of LPL has to be done according to IEC 62305 series.

If the transformer, frequency converter and / or medium-voltage switchgear are located outside the tidal turbine inside a surface-piercing platform or inside shore-based housing, the platform or the housing shall be protected according to the lightning protection level I (LPL I). A corresponding set of maximum and minimum lightning current parameters is to be found in IEC 62305-1, Tables 5 and 6.

12.9.3 Lightning protection zone (LPZ)

The tidal turbine manufacturer shall establish a lightning protection zone concept following the principles given in IEC 62305-4, clause 4. Each lightning protection zone has the task of reducing the electromagnetic field and the conducted emission disturbances to the stipulated values. The requirements for choosing one or the other lightning protection zone depend on the electromagnetic disturbance immunity of the equipment installed in the higher lightning protection zone.

At each zone boundary, it must be ensured that cables and wires crossing the boundary do not conduct large parts of the lightning current or voltage transients into the lightning protection



zone with the higher number. This is achieved by means of proper bonding and shielding practices and surge protection devices (SPD) of all cables and wires at the zone boundary.

Electrical systems and installations connected via transformer with the electrical grid have to be protected against the effects of lightning current, overvoltage and lightning electromagnetic impulses (LEMP). This should be done by means of equipotential bonding, magnetic and electrical shielding of cables and line routing, coordinated surge protection devices (in compliance with IEC 62305-4 Annex C) and earthing.

12.9.4 Surge protection devices

SPD protection is always required for all incoming cables (for power, control, telecommunication, etc.) at the entrance of a lightning protection zone. The number of required SPDs can be reduced by connecting or extending zones.

Surge arresters for low-voltage applications shall comply with

- IEC 61643-12 “Low-voltage surge protective devices – Part 12: Surge protective devices connected to low-voltage power distribution systems – Selection and application principles” for power systems
- IEC 61643-21 “Low-voltage surge protective devices - Part 21: Surge protective devices connected to telecommunications and signalling networks – Performance requirements and testing methods”

This shall be verified on the basis of product data sheets.

Surge arresters for high-voltage or medium-voltage applications shall comply with

- IEC 60099-1 “Surge arresters – Part 1: Non-linear resistor type gapped surge arresters for a.c. systems” for gapped surge arresters
- IEC 60099-4 “Surge arresters – Part 4: Metal-oxide surge arresters without gaps for a.c. systems” for metal-oxide arresters

This shall be verified on the basis of product data sheets.

Surge arresters shall be monitored. Maintenance and replacement of surge arresters shall be performed according to the manufacturer’s maintenance plan, which is required for assessment.

12.9.5 Equipotential bonding

Lightning protection zones can be interconnected via shielded cables (with the shield connected to the bonding system at both ends) or metallic conduits. Also, a lightning protection zone can be extended with a shielded cable to include an external metal sensor housing. The measures for connection and extension of lightning protection zones taken by the designer should be stated in the lightning protection documentation of the tidal turbine and additionally all shielding measures should be shown in the wiring diagrams. Examples for connected zones or extended zones can be found in IEC 62305-4 sub clause 4.2.

Equipotential bonding shall be achieved by interconnecting all non-current-carrying metal parts of the tidal turbine like structural metal parts, metal installations, internal systems and external conductive parts and service lines connected to the tidal turbine which are above water surface.

The bonding conductors should be kept as short as possible and should have a cross-sectional area according to IEC 62305-3, Tables 8 and 9.



In each lightning protection zone, local bonding bars shall be installed and shall be connected to each other.

Where possible, incoming cables should enter the lightning protection zone at the same location and be connected to the same bonding bar. If incoming cables enter the lightning protection zone at different locations, each cable should be connected to a bonding bar and the respective bonding bars of the zone should be connected (see IEC 62305-3 sub clause 5.4).

The equipotential bonding system shall be assessed on the basis of an equipotential bonding plan for all bonding and earthing in the tidal turbine, showing the general equipotential bonding system including the locations of the bonding bars within the different lightning protection zones, the bonding conductors with their cross-sectional areas as well as further relevant data.

Machines and equipment mounted on insulated vibration dampers are to be earthed via mobile cables, lines or copper braids.

12.9.6 Earthing system

Earthing system is only applicable for shore-based housing and for surface-piercing platforms.

The earthing system of housings for transformer, frequency converter and / or medium-voltage switchgear (shore-based as well as on surface-piercing platforms) shall be designed to provide sufficient protection against damage due to lightning flashes corresponding to the lightning protection level for which the lightning protection system is designed.

The earthing system shall be designed according to the requirements given in IEC 62305-3.

Guidance note:

The complete lightning protection system, as well as the earthing system, is to be checked by an independent expert according to the scope laid down in IEC 61400-24 clause 12, as a visual inspection at yearly intervals and as a full inspection at intervals not exceeding 2 years.

---e-n-d---o-f---G-u-i-d-a-n-c-e---n-o-t-e---

12.10 Array cabling

12.10.1 General

Tidal turbines can be erected in arrays. This section should give the relation between the single tidal turbine and the electrical components installed between the tidal turbine and the shore.

Design as well as type testing of AC power cores intended to be used for submarine cables shall be in accordance with standards

- IEC 60502 “Power cables with extruded insulation and their accessories for rated voltages from 1 kV ($U_m = 1.2$ kV) up to 30 kV ($U_m = 36$ kV)”
- IEC 60840 “Power cables with extruded insulation and their accessories for rated voltages above 30 kV ($U_m = 36$ kV) up to 150 kV ($U_m = 170$ kV) – Test methods and requirements”
- IEC 62067 “Power cables with extruded insulation and their accessories for rated voltages above 150 kV ($U_m = 170$ kV) up to 500 kV ($U_m = 550$ kV) – Test methods and requirements”



depending on the rated voltage. The same applies to the corresponding accessories. This shall be proven by declaration of the cable manufacturer or accessory supplier in the respective design documentation.

Fibre optics shall be designed and tested in accordance with the provisions of the International Telecommunication Union (ITU). This shall be verified through a data sheet of the manufacturer.

12.10.1.1 Current rating

For current ratings and determination of the required cross-sectional areas of submarine cables, the IEC 60287 series of standards shall be applied in considering the following aspects:

- 100% load factor shall be assumed for cable design. Relaxation of this requirement due to an economical point of view may be permitted after assessment of a detailed study or investigation report concerning annual current conditions and expected load phases at the site.
- Heat accumulation due to the installation in J-tubes or pipes shall be considered. The same applies to higher losses of pipe-type cables.

The submarine cable shall be designed to carry the maximum current without being damaged, neither thermally nor electrically. This shall be valid for normal operation, for low-voltage situations as well as for the defined generation of reactive power according to the rules given by the local utility.

12.10.1.2 Feeders

For cables connecting the feeders of tidal turbines, each cable shall have possibilities for being switched off and earthed effectively at both ends.

Guidance note:

If work at submarine cables shall be performed only by ROV (Remotely Operated Vehicles) and therefore there is no risk of personal safety, disconnection and earthing at both ends of each cable may not be mandatory. In this case the intended procedure of work at submarine cables shall be described.

---e-n-d---o-f---G-u-i-d-a-n-c-e---n-o-t-e---

To decrease the likelihood of failure, a second connection between two feeders can be implemented. In the event of cable failure, the possibilities of the ring can be used. Maximum possible currents have to be calculated accordingly. Normal operation should be with the ring open.

12.10.2 Type test

For mechanical type testing of stranded submarine cables, the following CIGRE Electra recommendations shall be applied for both export cables and the inter-array grid: "Recommendations for mechanical tests on submarine cables", pages 59 to 66 in ELECTRA No. 171, April 1997. Test logs of at least the following tests shall be provided for certification for each type of submarine cable:

- Coiling test (only applicable to cables coiled during manufacturing or laying)
- Tensile bending test



Test log of the water penetration test of the CIGRE “Recommendations for Testing of Long AC Submarine Cables with Extruded Insulation for System Voltage above 30 (36) to 500 (550) kV” TB490, February 2012 shall be provided.

Results of mechanical type tests can be extended to a range of submarine cables when materials, design and manufacturing procedures have not changed.

12.10.3 Factory acceptance test (FAT)

The FAT of each submarine cable manufacturing or delivery length shall include at least the following tests:

- High voltage AC test
- Partial discharge test
- Optical time domain reflectometry (OTDR) on optical fibres

Reference is made to the CIGRE “Recommendations for Testing of Long AC Submarine Cables with Extruded Insulation for System Voltage above 30 (36) to 500 (550) kV” TB490, February 2012. An inspection and test plan (ITP) shall be submitted for certification prior to manufacturing and testing.

12.10.4 Installation

The distance between parallel submarine cables shall generally at a minimum be two times the water depth plus the laying depth, in order to allow cable repair. Relaxation of this requirement is granted when submarine cable repair actions verifiably have no influence on parallel cables.

The burial depth of submarine cables should be in accordance with the local requirements concerning seabed warming, if any. A corresponding calculation study shall then be provided for assessment.

During submarine cable laying, no unacceptable forces shall occur at the cable. Maximum pulling forces shall be calculated for all submarine cable pull-in operations with consideration of

- the friction coefficients of soil and tubes
- bending radii
- cable weight in air
- pulling length

The ratio of the calculated required pulling forces to the tolerable pulling forces specified by the submarine cable manufacturer should be at least 1:3. Calculations as described above shall be submitted for certification.

Pulling forces shall be monitored during submarine cable installation. Cable tensioners shall be applied for tension and / or speed control.

When planning submarine cable trays crossing onshore tubes (e.g. in passing an island), the following issues might limit the maximum length of onshore crossings:

- Maximum allowed pulling force of the respective cable
- Pulling force has to be applied to the cable in a steady way

Depending on the soil conditions, submarine cables are put under the ground in different ways. The tools used for cable laying have to support the necessary bending radius of the cable. In no



situation shall the allowed maximum bending radius of the respective cable be exceeded. Cable protectors and bending restrictors should be installed whenever necessary to comply with the above-mentioned conditions.

Subsea cables shall be tested after installation according to suitable methods. The integrity of the cables shall be verified after installation, e.g. by using VLF testing for AC cables.

12.10.5 DC power systems

If the array is connected to shore via a HVDC system, the following recommendations shall be applied for testing of DC submarine cables, if these cables fall within the scope of assessment:

- “Recommendations for tests on power transmission DC cables for rated voltage up to 800 kV”, pages 39 to 55 in Electra No. 189, April 2000 and the addendum given in pages 39 to 45 in ELECTRA No. 218, February 2005
- “Testing DC extruded cable systems”, pages 47 to 53 in ELECTRA No. 206, February 2003 plus Technical Brochure No. 219

For the mechanical testing of DC submarine cables, [12.10.1] shall be observed.

13 CORROSION PROTECTION

13.1 General

In this section, the requirements and guidance for corrosion control of the following HATT subsystems are given

- Foundation
- Support structure
- Nacelle
- Hub
- Blades
- Internal system

Methods for corrosion control include corrosion allowance, cathodic protection, corrosion protective coatings, and use of corrosion resistant materials. In closed internal compartments, corrosion may also be mitigated by control of humidity or depletion of oxygen. The term corrosion control further includes the inspection and maintenance of corrosion protection systems during operation.

When corrosion allowance is part of the required corrosion protection, the corrosion allowance shall be considered in structural design for all limit state analyses by appropriate reduction of nominal thicknesses, see [13.3].

13.2 Corrosion zones and applicable methods for corrosion control

13.2.1 Atmospheric zone

Atmospheric zone may be considered for HATT designs involving surface piercing elements.

The Atmospheric zone is the zone that extends above the higher limit of the fixed splash zone.

For surfaces within the atmospheric zone, requirements and guidance for the corrosion protection are given in DNV-OS-J101, Section 11.2.1.

13.2.2 Splash zone

Splash zone may be considered for HATT designs involving surface piercing elements.

The splash zone is the part of a HATT which is intermittently exposed to seawater due to the action of tide, waves and/or HATT vertical displacements. As a consequence of this action, the corrosive environment is severe, maintenance of corrosion protection is not practical and cathodic protection is not effective for parts of this zone. Special requirements for fatigue design of structural components exposed to the splash zone apply, see Section 8. The definition of the splash zone and the requirements for corrosion protection are given in DNV-OS-J101, Section 11.2.2.

Some HATT designs may involve elements that can be lifted above the surface. For these components, the corrosion protection scheme shall be defined on a case by case basis, based on the proportion between time spent under water and above the surface.

13.2.3 Submerged zone

The submerged zone consists of the region below the lower limit of the fixed splash zone defined in [13.2.2], including the scour zone and the zone of permanently buried structural parts.

For surfaces within the submerged zone, requirements for the corrosion protection are given in DNV-OS-J101, Section 11.2.3.

Special attention shall be given to the connection of different materials with regard to contact corrosion, e.g. carbon fibres or stainless steel.

13.2.4 Transition zones

Transition areas are located on components making the transition between systems requiring different levels of corrosion protection. This is typically the main seal area, where the shaft and bearings are electrically connected to the hub and rotor, which are in contact with sea water, and the inside of the nacelle, a possibly closed and dry compartment.

Different types and/or levels of corrosion protection may be used in one single transition area. This applies where the area can be split into two or more electrically isolated sub areas.

Guidance note:

Note that in the case of a shaft being directly in contact with sea water and going through a dry nacelle, the use of cathodic protection, although possible, may be challenging, due to

- the rotary motion of the shaft,
- the cohabitation of different corrosion protection requirements along the shaft
- the cohabitation of different metals in the bearing area and the difficulty to assure electrical connection with the nacelle.

Coating may be used in the section of the shaft which is directly in contact with sea water. However, due consideration should be given to the design life of the coating given by the manufacturer, to ensure efficiency between maintenance intervals.

Other types of corrosion protections may be considered in this area, and shall be assessed on a case by case basis.

---e-n-d---of---G-u-i-d-a-n-c-e---n-o-t-e---

When electrically isolating two neighbouring areas, the possibility of generation of electromagnetic fields by moving parts shall be assessed and taken into account.

13.2.5 Effect of high current velocity on corrosion protection

HATT are to be deployed at highly energetic sites. The effect of high current velocity on the corrosion protection shall be taken into account and referred to in a documented study. High current velocity can have the following impact on corrosion protection:

- Causing high loading in anode fixings, causing the anodes to fall off due to forces and corrosion of fixings.
- Damage the coating through the blasting of sediments, thus causing anodes to be depleted more quickly than anticipated. The suitability of the coating for specific high current areas shall be demonstrated by the manufacturer, for example through testing.

- In addition to the standard environmental parameters to account for in the design of corrosion protection, such as, dissolved oxygen content, sea water temperature, marine growth and salinity, high current velocities can cause a higher demand for protective currents densities. Initial design current densities for all initially bare steel surfaces shall account for the effect of high sea current velocity on corrosion rates. Guidance on the influence of the speed on sea-current is given in DNV-RP-G101, Figure A-3.

Guidance note

The mean and final design current densities recommended in DNV-RP-B401 may be reduced to reflect provisions made for retrofitting of anodes as well as other factors reducing the need for inherent conservatism in the cathodic protection design.

---e-n-d---of---G-u-i-d-a-n-c-e---n-o-t-e---

13.3 Corrosion allowance

13.3.1 General

For zones described in sections [13.2.1] to [13.2.4], requirements for corrosion allowance are given in DNV-OS-J101, Section 11.3.

13.4 Cathodic protection

13.4.1 General

Guidance on the choice and suitability of cathodic corrosion protection is given in DNV-OS-J101, Section 11.4.

Special attention shall be given to the combination of cathodic protection with special materials, such as carbon fibres to avoid unintended behaviour of the current distribution. Test could be performed to measure the current distribution. Conductivity between different subsystems shall be planned with special care taking into consideration the individual structure (inside, outside, foam filled voids etc.).

Guidance note

This applies for example where carbon blades are used. Electrical connection between the blades and the cathodic protection can cause cathodic disbonding to occur, damaging the coating of the blade. Additional information is given in DNV-RP-B401, Section 5.5.

---e-n-d---of---G-u-i-d-a-n-c-e---n-o-t-e---

Unintended interaction between the CP system and any other electrical system shall be avoided.

13.4.2 Galvanic anode cathodic protection (GACP)

For zones described in sections [13.2.1] to [13.2.4], requirements for GACP are given in DNV-OS-J101, Section 11.4.2.

13.4.3 Impressed current cathodic protection (ICCP)

For zones described in sections [13.2.1] to [13.2.4], requirements for ICCP are given in DNV-OS-J101, Section 11.4.3.



13.5 Corrosion protective coatings and corrosion resistant materials

13.5.1 Corrosion protective coatings

For zones described in sections [13.2.1] to [13.2.4], requirements for corrosion protective coatings are given in DNV-OS-J101, Section 11.5.1.

13.5.2 Corrosion Resistant materials

For zones described in sections [13.2.1] to [13.2.4], requirements for corrosion resistant materials are given in DNV-OS-J101, Section 11.5.2.

14 FABRICATION, TRANSPORT, INSTALLATION, COMMISSIONING AND RETRIEVAL

14.1 Certification surveillances

The target of this section is summarizing the requirements in respect of Certification Surveillances required by the prototype and project certification schemes:

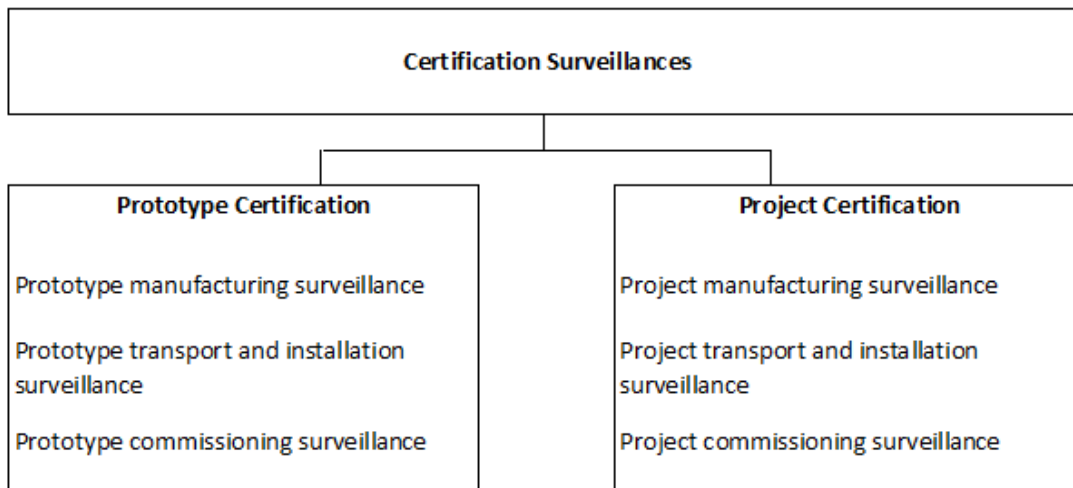

Purpose of the Certification Surveillances is assurance of structural integrity and safety of the tidal turbines, offshore substations, infield cabling by witnessing of certification requirements fulfilment within fabrication, transport, deployment, commissioning operations.

14.2 General requirements to marine operations documentation

Marine operations should be planned and prepared to bring an object from one defined safe condition to another according to safe and sound practice, and according to defined codes and standards. The planning of the operations should cover planning principles, documentation and risk evaluation.

The planning procedures should include assessment of personnel exposure and possibilities for reducing this through use of remotely operated tools and handling systems. The project risk should be managed through a planned risk management process. A Risk Management Plan (RMP) should be prepared in order to describe, communicate and document activities and processes necessary for managing, through all project phases, the risk involved in the planned marine operations. DNV-RP-H101 gives guidance on how to manage and mitigate risks related to marine operations.

The planning and design sequence is given in Figure 14-1.



Figure 14-1 Planning and design sequence



Operational prerequisites such as design criteria, weather forecast, organisation, marine operation manuals as well as preparation and testing should be covered.

Acceptable characteristics shall be documented for the handled object and all equipment, temporary or permanent structures, vessels etc. involved in the operation. All elements of the marine operation shall be documented. This also includes onshore facilities such as quays, soil, pullers and foundations.

Properties for object, equipment, structures, vessels etc. may be documented with recognised certificates. The basis for the certification shall then be clearly stated, i.e. acceptance standard, basic assumptions, dynamics considered etc., and shall comply with the philosophy and intentions of DNV-OS-H101.

Operational aspects shall be documented in the form of procedure, operation manuals, certificates, calculations etc. Relevant qualifications of key personnel shall be documented.

All relevant documentation shall be available on site during execution of the operation.

Documentation for marine operations shall be self-contained or clearly refer to other relevant documents. The quality and details of the documentation shall be such that it allows for independent reviews of plans, procedures and calculations for all parts of the operation. A document plan describing the document hierarchy and scope for each document is recommended for major marine operations.

Applicable input documentation such as:

- statutory requirements
- rules
- company specifications
- standards and codes
- concept descriptions
- basic engineering results (drawings, calculations etc.)
- relevant contracts or parts of contracts

should be identified before any design work is performed.

Necessary documentation shall be prepared to prove acceptable quality of the intended marine operation. Typically, output documentation consists of:

- planning documents including design briefs and design basis, schedules, concept evaluations, general arrangement drawings and specifications
- design documentation including load analysis, global strength analysis, local design strength calculations, stability and ballast calculations and structural drawings
- operational procedure including testing program and procedure, operational plans and procedure, arrangement drawings, safety requirement and administrative procedures
- certificates, test reports, survey reports, NDE documentation, as built reports, etc.

Execution of marine operations shall be logged. Samples of planned recording forms shall be included in the marine operations manual.



Systems and equipment shall be designed, fabricated, installed and tested in accordance with relevant codes and standards. Systems and equipment shall be based on a thorough consideration of functional and operational requirements for the complete operation. Emphasis shall be placed on reliability and contingency.

14.3 Manufacturing surveillance

Before surveillance during production (manufacture) begins, certain quality management (QM) requirements shall be met by the manufacturers. As a rule, the QM system shall be certified according to ISO 9001 (at least ISO 9001:2008), otherwise the QM measures will be assessed by DNV GL.

The extent and amount of the surveillance during production depends on the standard of the quality management measures, and shall be agreed with DNV GL. In general, the following actions and approvals will be carried out by DNV GL:

- inspection and testing of materials and components
- scrutiny of QM records, such as test certificates, tracers, reports
- surveillance of production, including storage conditions and handling, by random sampling
- inspection and testing of materials and components of the support structure
- inspection of the corrosion protection
- inspection of the electrical power system
- supervision of the final test

The objective of the surveillance during production is to verify whether the manufactured parts, components and products are in compliance with

- the technical specifications agreed upon in the specific project,
- the documents certified by DNV GL (calculations, drawings, procedures etc.).

In the case of project certification at least 25% of each component (and multiple suppliers, if any) have to be surveyed by DNV GL, whereas DNV GL is obligated to follow up quality-relevant nonconformities found during the surveillance. Quality-relevant nonconformities and their consequences are communicated shortly after their finding. In case the requirements are not met, the amount of surveillance will be increased accordingly.

14.4 Transport and installation surveillance

Transport and installation procedures, which if necessary take account of the special circumstances of the site and results of site specific design assessment, shall be submitted for check of the compatibility with the assessed design and with the prevailing transport and installation conditions (climate, job scheduling etc.).

A site plan showing the location of the tidal turbine(s) shall be submitted, together with plans of the electrical installation showing how the plant will be connected to the public grid.

The extent and amount of surveillance activities depends on the quality management measures of the companies involved in transport and installation. As a rule, DNV GL will carry out the following activities:

- 
- inspection of sea fastening appropriateness
 - monitoring of marine operations harmlessness
 - identification and allocation of all components to the tidal turbine in question
 - checking the components for damage during transport
 - inspection of the job schedules, sequences and timing (e.g. for welding, installation, bolting up)
 - inspection of prefabricated subassemblies, and of components to be installed, for adequate quality of manufacture, insofar as this has not been done at the manufacturer's workshop
 - surveillance of important steps in the installation on a random-sampling basis (e.g. pile driving, grouting)
 - inspection of grouted and bolted connections, surveillance of non-destructive tests (e.g. welded joints)
 - inspection of the installation and functionality of corrosion protection
 - inspection of the scour protection system
 - inspection of cable laying and trenching
 - inspection of the electrical installation (cables pull-in, equipment earths and earthing system)

In the case of project certification the transportation and installation of at least 25% of the tidal turbines have to be surveyed by DNV GL, whereas DNV GL is obligated to follow up major damages with impact to the integrity of the tidal turbine found during the surveillance. Quality-relevant nonconformities and their consequences are communicated shortly after their finding. In case the requirements are not met, the amount of surveillance will be increased accordingly.

14.5 Prototype commissioning surveillance

The commissioning procedure shall be surveyed at the prototype. This includes the installation onshore (e.g. powerhouse, remote control station). The objective of this surveillance is the visual inspection of a plant by DNV GL and the assessment of the safety-related tests in the documentation for commissioning.

The configuration of the prototype to be commissioned shall be confirmed in a declaration by the manufacturer to be submitted to DNV GL prior to the surveillance. This declaration shall list at least the types and serial numbers of the main components, such as rotor blade, rotor brake, gear box, generator, converter, power transformer, establishment, yaw motor and gear, pitch motor and gear, and additionally of the electrical cabinets.

Prototype commissioning surveillance shall be performed by two DNV GL experts: one each from the fields of electrical systems and safety technology.

Successful execution of the commissioning surveillance is a prerequisite for issuance of the prototype certificate.

The implementation planning of the commissioning surveillance depends on the accessibility for visual inspections and the conditions for testing of the different components and systems of the tidal turbine.



Depending on the accessibility and the conditions for testing the commissioning surveillance may have to be performed in several iterations.

14.5.1 Procedure of the prototype commissioning surveillance

The tidal turbine is inspected and the technical execution is compared to the design on which the Design Assessment is based, using the declaration from the manufacturer mentioned above.

Compliance with any restrictions and / or conditions expressed in the Certification Reports (for reporting the assessment of the design documentation) is assessed as far as possible.

Selected tests from the documentation for commissioning are carried out with focus on the safety related tests. In addition, the practicability of the tests is verified and the turbine behaviour is assessed for compliance with the design documents.

14.5.1.1 Scope of visual inspection of electrical systems

The type of the electrical components and the incorporation of the electrical installations into the tidal turbine and lightning protection system into the installation onshore shall be inspected. The inspection mainly comprises the following fields:

- installation of the electrical cabinets (earthing, connection of the incoming cables, fill factor of cable channels etc.)
- installation of generator, frequency converters and motors (earthing, check of rating plates etc.)
- installation of the medium-voltage switchgear in accordance with the IAC-Classification
- cable routing and installation (bending radius, distance between cables according to the specified installation method, installation of cable loop in the yaw section, installation and filling factor of cable trays and pipes, connection of shields, identification of cables in accordance with the wiring diagrams etc.)
- installation of the lightning protection system (installation of down-conductor system, installation of brushes, spark gaps and surge arresters, connection of the down-conductor system to the earth electrode, installation of bonding bars, achievement of shielding measures etc.)
- inspection of protection settings and their permanent marking.
- inspection of the parameter set for the electrical rotor-blade pitch converter (if applicable) to be compliant with the parameters assessed during Design Assessment.
- inspection of the air flow concept inside the hub and nacelle/housing according to [12.1.7].

14.5.1.2 Scope of visual inspection of hydraulic systems

Identification whether systems and components conform to the system's specifications.

Connection of components in the system complies with the circuit diagram.

Validation of adjustment values to the system's specifications.

Validation of monitoring devices (i.e. pressure switch) for proper function.

Identification whether the hydraulic system, including all safety components, functions correctly.



Assurance that there is no measurable unintended leakage other than slight wetting insufficient to form a drop after the system is subjected to either the maximum working pressure or a pressure defined by the manufacturer.

14.5.1.3 Scope of visual inspection of mechanical system

Inspection of technical execution of the mechanical structure, i.e. screw connections.

Additional issues depending on the tidal turbine concept.

14.5.1.4 Scope of visual inspection of corrosion protection systems

Validation check of the type and location of sacrificial anodes to the system's specification of cathodic corrosion protection.

Inspection of corrosion protection coating regarding damages, and if required, additionally measurement of its thickness at critical areas.

Check of the adjustment values to the impressed current system's specification if applicable.

14.5.1.5 Surveillance of safety related tests from the documents for commissioning

If protection functions are realized by programmable devices, the logic of these devices shall be demonstrated by functional testing.

If, after activation of a protection function, a remote reset is applicable, it shall be demonstrated that the stipulated prerequisites are met.

The following tests have to be performed during the commissioning surveillance to check the behaviour of the tidal turbine and the functional conformity of the protection functions to the Design Assessment, see Section 11:

- check of settings and limiting values for the protection functions
- test of rotor lock device
- test of the independence of the protection functions from the control system
- test of emergency stop functions, at least once during operation
- activation of all braking procedures
- check of tidal turbine behaviour in the case of failure in the energy backup for protection- and control functions
- test of activation of the protection functions in scope of control concept
- check of tidal turbine behaviour in case of load shedding
- check of settings and limiting values of the vibration monitoring
- test of mechanical interlocking system to the establishment, if applicable.
- test of electrical interlocking system to the sea cable, if applicable
- running tidal turbine for plausibility check of operational parameters i.e. current direction and speed, power output, rotational speed and temperatures
- additional tests depending on the tidal turbine concept.

14.6 Project commissioning surveillance

Project commissioning surveillance is to be performed for all tidal turbines of the array and shall finally confirm that every tidal turbine is ready to operate and that the tidal turbine fulfils all standards and requirements to be applied.

In the case of project certification commissioning surveillance covers witnessing by DNV GL inspector of at least 10% of the tidal turbines during the actual commissioning, whereas DNV GL is obligated to follow up quality-relevant nonconformities found during the surveillance. Quality-relevant nonconformities and their consequences are communicated shortly after their finding. In case the requirements are not met, the amount of surveillance will be increased accordingly.

In the course of commissioning, all the functions of the tidal turbine derived from its operating mode shall be tested. This includes the following tests and activities:

- functioning of the emergency stop buttons
- testing of all braking programs
- functioning of the yaw system, if applicable
- behaviour at loss of load (grid loss)
- behaviour at overspeed
- functioning of automatic operation
- visual inspection of the installation as far as possible
- checking the logic of the control system's indicators
- operation of ballast system and bilge pumps, if applicable
- draught and stability for floating structures
- check of the functionality of corrosion protection
- check on damages
- conformity of the main components with the certified design, traceability and numeration

Overall project commissioning surveillance activities have to be divided into onshore commissioning at the manufacturer yard, harbour pre-sail commissioning and offshore post-installation commissioning, see Table 14-1.

Table 14-1 Typical activities within commissioning of tidal turbine (informative)

<i>Onshore commissioning at the manufacturer yard</i>
Transformer: insulation tests of the magnetic circuit and windings, auxiliary systems checks... Switchgears: insulation tests, functionality checks... Generator: insulation tests... Heating systems: leakage-free operability... Sealing: leakage-free operability... CCTV: functionality check of cameras... Navigational aid: operability of aviation obstruction lights, 5 nautical miles lantern; operability of AIS, etc. Gearbox: ... DC system / batteries. SCADA, control systems telecommunications. Integrated testing: check of operability of the overall installation.
<i>Harbour pre-sail commissioning</i>
Visual inspection... Checks of LV-equipment: control and safety system, heating, telecommunications, SCADA . Check of removal of navigational equipment. Check of insulation resistance of primary equipment. Functional and operational tests on switchgear locally and from SCADA. Check of auxiliaries. Integrated testing: check of operability of the overall installation.
<i>Offshore post-installation commissioning</i>
Operation monitoring, tests and checks. Operation monitoring of export cables on overloading incl. by infra-red-cameras. Operation monitoring and checks of control and safety systems. Operation monitoring of power grid connection compliance.

Before project commissioning surveillance starts, commissioning documentation i.e. description of all onshore, harbour and offshore commissioning activities planned shall be submitted, see [3.3].

Before the start of the offshore post-installation commissioning, the manufacturer shall provide proof that tidal turbine has been erected properly and, as far as necessary, tested to ensure that operation is safe. In the absence of such proof, appropriate tests shall be carried out when putting the tidal turbine into operation.

14.7 Retrieval

Tidal turbine shall be removed in accordance with building permission. Detailed planning shall be drawn up for the retrieval procedures in advance prior the start of retrieval. Retrieval procedures shall be documented and become part of the installation manual.

During the retrieval, all significant components and assemblies shall be assessed and certified integrity for the retrieval from the installation location site to the recycling place in order to exclude dangers to personnel and risks to equipment and the environment.

National and local rules and regulations shall be observed. Surveillance of the retrieval works by DNV GL can be required depending on the national and local rules and regulations.

15 MAINTENANCE AND PERIODICAL INSPECTIONS

15.1 General

This section summarizes requirements in respect of following actions necessary for keeping the commissioned tidal turbine in working condition within its operational lifetime:

- planned preventive maintenance, which is time-based maintenance with activities scheduled at predetermined time intervals
- condition-based maintenance based on remote automatic monitoring of components condition, necessary for the prediction or detection of the components damage on an early stage.
- periodical inspections, which shall be carried out periodically with involvement of the DNV GL to maintain the validity of the prototype or project certificate.

Guidance note

These actions are necessary for handling of slow-going changes of turbine condition e.g. scour, corrosion, mechanical wear, crack formation, etc. Protection functions (see Section 11), in contrast, are intended for keeping the turbine within the design limits at prompt sudden changes (e.g. sudden load increase due to abrupt weather condition change).

---e-n-d---of---G-u-i-d-a-n-c-e---n-o-t-e---

Intervals between maintenance works and periodic inspections shall be planned to provide adequate assurance that no significant deterioration in the condition of the turbine can arise in the interval.

Periodical inspections can be combined with the execution of maintenance works to avoid abundant retrievals of the tidal turbine.

Within the development of the tidal turbine design the feasibility and reliability aspects of maintenance and periodical inspections shall be considered, including

- retrieval and installation execution approach, e.g. float-up retrieval, installation by winching, lowering by gravity
- specifications of the equipment necessary for the execution of maintenance activities, e.g. Remote Operated Vehicles (ROV), special tools or lifting devices, installation vessels
- environmental limiting conditions (wind speed, wave height, temperatures)
- tidal turbine settings within retrieval and installation execution, e.g. position of rotor, nacelle, activation of locking devices, etc.

15.2 Planned preventive maintenance

The body responsible for the tidal turbine operation (called the operator in the following) is responsible for the organization of the Planned Preventive Maintenance. Involvement of the DNV GL is not required.

Planned Preventive Maintenance activities shall ensure safe functioning of the tidal turbine and include

- supervising actions and tests

- reconditioning (e.g. refilling, lubrication)
- repairing / exchange
- adjusting and cleaning.

Planned Preventive Maintenance activities are scheduled at predetermined time intervals (calendar months or runtime hours) based on the available mean-time-to-failure statistic and results of Failure Mode Identification and Risk Ranking (FMIRR, see [1.10.3.3])

Guidance note

Offshore Reliability Data (OREDA) is recommended data source on failure rates, failure mode distribution and repair times for equipment used in the offshore industry.

---e-n-d---of---G-u-i-d-a-n-c-e---n-o-t-e---

Planned Preventive Maintenance program shall be duly described in the maintenance manual as per Section 3.5, covering maintenance activities on support structure / foundation, machinery components and electrical installation.

15.3 Condition-based maintenance

Condition-based maintenance requires continuous monitoring of components condition by means of a condition monitoring system (CMS) with the target of

- early detection of damage to the monitored components and prevention of secondary damage
- possibility of classifying the damage using frequencies typical of a certain component
- effective scheduling of the maintenance downtimes.

Condition-based maintenance approach shall be duly described in the maintenance manual as per [3.5].

CMS for tidal turbines can include measurement of structure-borne sound and vibration at parts of the drive train and rotor blades, combined with the acquisition of operational parameters, e.g. power output, speed, and the oil and bearing temperatures.

Results of Failure Mode Identification and Risk Ranking (FMIRR) shall be a basis for the selection of components and operational parameters to be monitored by CMS.

Guidance note

Following main components are considered as essential for the condition monitoring:

- main bearing(s)
- main gearbox
- generator(s).

Additionally it may be reasonable to monitor

- tower
- rotor blades
- foundation



Following operational parameters are considered as essential for the condition monitoring:

- current direction
- outside water temperature
- nacelle temperature
- temperature of dedicated bearings of the gearbox and the generator
- temperature of the generator windings
- oil temperatures and pressure (e.g. hydraulic oil, gear oil)
- messages about interventions in the control of the turbine (e.g. active adjustment of nacelle position, activated hydraulic pump)
- blade vibration
- gearbox oil cleanliness, particle counting.

Additional information about the status of the tidal turbine and its components can be given by using camera(s) and microphone(s) or other suitable methods at characteristic places of the tidal turbine. The complete CMS incl. sensors, cables etc. shall

be adequate for use under offshore conditions and shall be so designed that its functions will not be disturbed.

---e-n-d---of---G-u-i-d-a-n-c-e---n-o-t-e---

For the implementation of condition monitoring system in the tidal turbine / arrays following guideline is recommended as guidance:

- GL Rules and Guidelines, Industrial Services, Guideline for the Certification of Condition Monitoring Systems for Wind Turbines, Edition 2013

Condition monitoring system shall be certified either

- within type certification of overall tidal turbine, or
- within component certification of CMS. In this case it has to be checked whether the conditions given in the Certification Report of the CMS will be fulfilled by using the CMS in that specific tidal turbine.

15.4 Periodical inspections

The objective of Periodical Inspections is regular inspection of the condition of the machinery, the safety devices and the integrity of the entire tidal turbine, cable connection, power house with involvement of the DNV GL to maintain the validity of the prototype or project certificate.

The operator is responsible for overall organization of the Periodical Inspections. The inspection shall be carried out by an approved technical expert. The expert shall have the necessary technical knowledge for assessment of the complete tidal turbine. The relevant training and a continuous exchange of experience shall be proven. An accreditation according to DIN EN ISO IEC 17020 or 45011 or equivalent is required, or the aptitude of the expert shall be checked by



a competent examination board and accepted by DNV GL. The technical expert shall be independent and shall have access to the relevant technical documentation of the tidal turbine.

Periodical Inspections Manual shall be duly described in the correspondent documentation, see [3.6].

Inspection intervals and components subject of inspections shall be stated in the Periodical Inspections Manual in due consideration of

- results of Failure Mode Identification and Risk Ranking
- results of the design assessment summarized in the Certification Reports related to the type certification as well as to site specific design assessment
- results of surveillance within manufacturing, transport, installation and commissioning
- results of maintenance works
- results of previous Periodical Inspections

During Periodical Inspection the complete tidal turbine including the rotor blades shall be inspected thoroughly. Following components are essential for the Periodical Inspections:

- rotor blades
- drive train
- nacelle and force- and moment-transmitting components
- seals, dehumidifiers
- hydraulic system, pneumatic system
- support structure (tower, sub-structure and foundation)
- safety devices, outside lighting, sensors and braking systems
- control system and electrics including transformer station and switchgear
- condition monitoring system
- corrosion protection
- scour protection
- interconnecting power cables

The tidal turbine shall be checked by visual inspection, whereby the individual components including the rotor blades shall be examined closely and the areas to be examined shall be cleaned or uncovered if relevant. Visual inspections may be carried out by a remotely operated vehicle.

Structural integrity of the tidal turbine including machinery, and functioning of the safety and braking systems, shall be checked as well.

The scour protection, seabed level, underwater structure and splash zone shall be checked by approved experts on site.

The structure within the splash zone (if any) shall be inspected visually with regard to corrosion, condition of welds, marine growth and damage, e.g. from collision. Generally, marine growth must be removed for inspection. Where damage is found that could extend further down, diver



inspections may be called for. Plate thickness measurements may be required where there is evidence of excessive corrosion. This shall be stated in the inspection report.

The concrete surfaces shall be inspected for cracks, abrasion, sprawling and any signs of corrosion of the steel reinforcement and embedments, particularly in the splash zone, in areas exposed to sea ice, and where repairs have been carried out previously. Cleaning of the surface may be necessary. The result of the inspection shall be stated in the inspection report.

The type, location and extent of corrosion control (i.e. coatings, cathodic protection system etc.) as well as its effectiveness, and repairs or renewals shall be stated in the inspection report.

Interconnecting power cables between the tidal turbines and the transformer station as well as power cables to the shore shall be inspected, unless they are buried.

15.4.1 Inspection report

Results of the periodical inspection shall be assessed on the basis of the present Standard and summarized in the correspondent Inspection Report. Standards and regulations valid at the site shall be observed and applied.

The Inspection Report on the Periodical Inspection shall be written and signed by the technical expert. The Inspection Report shall contain the following information at least:

- manufacturer, type and serial numbers of the tidal turbine
- serial numbers of main components (gearbox, generator, main shaft etc.)
- location and operator of the tidal turbine
- operating hours and total energy produced
- date and climate conditions (weather) on the day of inspection
- persons present at the inspection

The results, the deficiencies found and the necessary conditions and restrictions shall be stated (e.g. a timeframe for competent repair).

If deficiencies endanger the structural integrity of the tidal turbine partly or completely, or if deficiencies can be expected to result in greater damage, the DNV GL shall recommend the decommissioning of the turbine. Decommissioning shall then be carried out by the operator.

The DNV GL shall inform the body responsible for the building and / or operation permit if public safety or the public environment or sea transport is endangered due to the deficiencies and if the operator refuses to decommission the tidal turbine. After repair of the turbine by a specialized workshop, the workshop shall attest the proper repair of the safety shortcomings in writing to the operator. After that, the operator / owner may initiate the re-commissioning.

16 CERTIFICATION PROCEDURES

16.1 Introduction

Certification according to this standard is a procedure by which a DNV GL gives written assurance that a product and coupled with it manufacturing, commissioning, operation and maintenance processes or services conform to requirements specified in this standard.

DNV GL shall ensure independency of the parties involved. The DNV GL and its staff responsible for carrying out the inspection shall not be the designer, manufacturer, supplier, installer, purchaser, owner, user or maintainer of the items which they inspect, nor the authorized representative of any of these parties.

The DNV GL shall ensure confidentiality of information obtained in the course of its inspection activities. Proprietary rights shall be protected.

Level of comprehensiveness within the conformity assessment shall be sufficient to assure that the design of the tidal turbine is in compliance with provisions of this standard.

Following certification schemes are defined in this standard and described below in the correspondent sub-sections:

- Prototype Certification
- Type Certification
- Component Certification
- Project Certification

The certification principles and the use of risk-based approach are given in [1.10].

16.2 Overall certification scope

16.2.1 General

The certification scope comprises of the following general steps:

- Design Basis Assessment
- Design Assessment
- Test Plan Evaluation
- Manufacturing Surveillance
- Manufacturing Assessment
- Installation Evaluation
- Final Evaluation / Commissioning Inspection
- Type Testing And Type Characteristic Measurements
- Periodical Inspections.

For specific requirements applied to Prototype, Type, Component and Project Certification, refer to respective sections below.

16.2.2 Design basis assessment

The Design Basis will be reviewed by DNV GL and should provide the key information related to the design, parameters for operation and survival (including accidental scenarios and abnormal conditions) and installation and maintenance.

The Design Basis Assessment should provide the following items as relevant, but not limited to:

- general system description
- functional and metocean limitations and main data
- provisions for authority requirements
- main principles for fabrication, transportation, installation, commissioning, operation and maintenance as well as abandonment
- interfacing system requirements
- materials selection
- environment inside the nacelle
- functional loads
- main principles for manufacturing and quality assurance
- reliability targets.

16.2.3 Load assessment

The following aspects are to be considered

- ULS loads
- FLS loads
- ALS loads.

The assessment of load is performed considering the following:

- methodology for the derivation of loading
- verification of functional and metocean limitations considered in the loading derivation
- verification of parameters used for derivation of loading (including control parameters)
- verification of structure, foundations and blade representation
- verification of simulation used for loading derivation
- confirmation of critical load cases for extreme condition
- checking of load at blade root, rotor, nacelle support and based shear and maximum overturning moments
- methodology used for validation of analytical model focused on the global forces.

An independent verification by DNV GL will be performed to assess the magnitude of loading for selected cases.

Load assessment may also be based on the analysis of data gained within the assessment of turbines with similar dimensioning and design. This is possible if the extreme loads and fatigue loads can be compared with those of other tidal turbines of similar size.

If a tidal turbine of a larger type is submitted for assessment, then the pertinent values shall be extrapolated with due consideration for the physical circumstances.

16.2.4 Design assessment

Its purpose is a complete examination of the tidal turbine design including verification of the assumptions by required material and component tests. In case that components like support structure and foundation are not included in the assessment, the dynamic influence of the virtual support as well as the loads acting on a virtual support structure are to be considered in the load assumptions.

For the assessment of the design, the manufacturer shall submit a full set of documents in the form of specifications, calculations, drawings, descriptions and parts lists. The documents for control and safety system concepts load case definitions and load assumptions will be assessed first.

Requirements for the Design Assessment are defined in the correspondent sections of the Standard:

Table 16-1 Location of design requirements

<i>Requirements</i>	<i>Sections</i>
Loads	2, 4, 5 and 6
Support structure	2, 5 and 6
Support structures mechanical	2, 5 and 8
Machinery systems and components	2, 10 and 11
Blades	2, 7 and 9
Electrical systems and components	13
Protection functions and safeguarding	12
Manuals	3
Material and component tests	18

16.2.5 Test plan evaluation

A Test Plan shall be submitted for evaluation. The Test Plan shall specify main components to be tested during the test period and loads to be documented during the tests.

- safety and function tests
- blade tests
- load measurements
- power performance measurements
- other tests.

The instrumentation is to be verified whether following requirements are fulfilled:

- protection functions and safeguarding resulting from the risk assessment are available;
- condition monitoring system monitors main components;
- measurement values necessary for the verification of design assumptions are sensed and considered in prototype testing and measurements plan.



Special care shall be taken with regard to the number of sensors to be installed, the location of the sensors, their working range and accuracy. The correlation between metocean loads acting in the device and information provided by the sensors at the different parts of the turbine and supporting structure is to be clearly established. The precision of the instrumentation used for site characterisation should be compatible with the accuracy of sensors in the turbine and supporting structure. More information is provided in [17.8] and [17.9].

16.2.6 Manufacturing surveillance

The Manufacturing Surveillance will be carried out by DNV GL. The extent of the surveillance and the amount of samples to be surveyed depends on the standard of the quality management measures, the requirements of this standard and the actions in the certification plan and shall be agreed with DNV GL.

Manufacturing Surveillance shall ensure that the requirements specified in the documentation subject to Design Assessment are observed and implemented within the manufacturing and storage of tidal turbine or its components. In addition it shall be demonstrated that requirements in respect of the quality management system are met.

Where surveillance by DNV GL is required, the following will normally be verified:

- that the construction and dimensions comply with relevant standards and the approved documentation
- that the required materials are used
- that the materials, components and systems have been certified in accordance with relevant standards and Certification Plan
- that the work is carried out in compliance with relevant standards and with good engineering practices
- that satisfactory tests are carried out to the extent and in the manner prescribed by relevant standards.

Surveillance will be carried out at the building yard and/or the sub-suppliers at the discretion of DNV GL, which also decides the extent and method of control.

The verification method applied by DNV GL at the building yard or at the manufacturer will be based on a combination of audits of an accepted quality system and visual inspections and tests.

16.2.7 Manufacturing assessment

For serial production, Manufacturing Assessment in the production facilities can be considered and used for reduction of manufacturing surveillance of an individual HATT. Manufacturing Assessment takes place once. Renewal of the Manufacturing Assessment can be necessary in the event of:

- design modifications to the tidal turbine or major components
- changes in the manufacturing processes, which can potentially influence the production quality or component properties
- changes to manufacturing facilities
- deviations or malfunction in the operation of the tidal turbine that can be ascribed to manufacturing flaws.



The extent of the Manufacturing Assessment depends on the standard of the quality management measures and shall be agreed with the DNV GL. As a minimum, the QM system shall meet the requirements of ISO 9001, whereby ISO 9000 defines fundamentals and vocabulary and ISO 9004 contains a QM approach for sustained success of an organization. The QM system shall be worked out in detail in writing. The QM system consists of at least a manual, procedures and work instructions in sufficient detail. For the manufacturers of products who do not pursue their own development activities, the exclusion of Clause 7.3 (“Design and development”) within ISO 9001 is permissible.

The descriptions of the quality management measures in production shall be presented in a summarizing document for the corresponding component or assembly. The quality management examinations can be supported by means of drawings, specifications and specimen documents.

The manufacturers shall have at their disposal suitable facilities and equipment for faultless execution of the work. External facilities may be included for consideration only if these meet the prerequisites for competent execution and are available without restriction.

Equipment and facilities include, on the scale necessary for the manufacture in question, for instance the following:

- workshops, roofed-over working areas as required, equipment for assembly sites
- store-rooms for materials
- drying facilities (e.g. for wood, welding fillers etc.)
- lifting gear for assembly and transport
- processing machinery and tools
- tools and equipment for welding and cutting
- appliances for joining-up, and for welding, laminating, bonding and gluing
- air-condition monitoring instruments.

The personnel employed by the company shall be such as to ensure that the components can be competently prepared, manufactured and tested to the extent necessary. DNV GL may require proof of the technical qualifications of the staff.

It shall be decided in each individual case whether the conformity can be inspected in the component manufacturer’s works or as part of the incoming inspection of the tidal turbine manufacturer.

16.2.8 Installation evaluation

Transport and installation surveillance is to be carried out by DNV GL. The necessity and extent of the installation surveillance shall be agreed with DNV GL; they depend on the total number of units to be installed and quality management measures within installation procedures as well as the Marine Warranty Surveyor scope. Details on the surveillance during transport and deployment are given in Section 14.

16.2.9 Final evaluation / commissioning inspection

A commissioning inspection plan shall be agreed with DNV GL. Successful execution of the commissioning inspection is a prerequisite for issuance of the final acceptance and issuance of the prototype certificate. Details on the surveillance during commissioning are given in Section 14.



The commissioning surveillance is integral part of the certification having following objectives:

- visual inspection of the HATT
- witnessing and evaluation of the safety-related tests selected by DNV GL from the commissioning manual
- witnessing and evaluation of condition monitoring system functionality.

16.2.10 Type testing and type characteristic measurements

Verification by prototype testing and measurements is required to verify, whether the assumptions for the design driving loads as well as behaviour of the control and safety systems being assessed and approved within the Design Assessment match with those measured or witnessed during prototype testing and measurements. Such verification is necessary to capture observable shortcomings and deviations from models used within the development of the tidal turbine as well as during the Design Assessment. Requirements in respect of the prototype testing and measurements are specified in Section 17.

16.2.11 Periodical inspections

The Periodical Inspections are required for the maintenance of prototype certificate and any long-term extension validity. Details on the scope of Periodical Inspections are given in Section 15.

In order to maintain the certificate the tidal or wave energy converter will need to undergo regular survey. Typically this will involve an annual survey and a more comprehensive 5 yearly survey. The extent of the survey (areas, methods, frequencies) will normally be dictated by the design life, degradation mechanisms and the consequences of possible failure. Additional surveys and Design Assessment may need to be carried out should the converter or one of a similar design sustain damage, or if it significantly modified (changes in the loading and structural response, power output, safety and control systems and changes other than replacements, see also [16.6.3]) in the periods between regular surveys.

Guidance note:

As an example, for the case where a single structure supports two turbines the DLC table needs to be supplemented for the cases where one turbine is operational and the other is parked. All possible combinations shall be addressed.

The annual survey will normally be general visual inspection of structures and main components in easy accessible areas. Every five years the survey will be a combination of general and close visual inspection. The determination of number of details for close visual inspection will be based on the fatigue utilisation, service life of components and risk considerations. Recommendations for non-destructive examination (NDE) may also be given by DNV. The in-service inspection scope should be established at the completion of the design phase prior to installation.

At the survey other aspects covered within the certification will also be reviewed. This may include results from the monitoring system, review of measurements of loading and structural response, records of incidents and maintenance carried out as well as agreements between actual and expected power take-off. Depending on the criticality of components of the power take-off system, the DNV surveyor should also attend the maintenance for visual inspection and condition assessment of the components.

---e-n-d---of---G-u-i-d-a-n-c-e---n-o-t-e---



The survey timing and methods will take account, as far as possible, of the inspection and maintenance programs adopted by the Operator.

Planning for the operations phase and the need for inspection and maintenance shall be part of the Operators design and construction philosophy. The extent and type of survey shall be discussed with DNV as part of this process.

16.2.12 Documentation for certification

The typical documentation to be submitted in connection with certification is described below. The level of detail and areas to be covered will obviously depend on the certification phase.

Depending on the type of device, parts of or whole groups of documentation described in the following will not be relevant. A detailed list reflecting the type of converter and operational mode must therefore be established in each case.

More information on documentation to be submitted is given in the different parts of this standard.

16.2.12.1 General information

The following general information should be submitted:

- General description of tidal turbine, including energy conversion concept (generator – converter – system).
- Listing of the primary components to be used (e.g. main bearing, gearbox, brake, generator, converter etc.).
- Design Basis including map of the installation location, bathymetry, metocean site conditions (currents, sea states, ice, currents, tidal levels), load case definitions as well as assumptions for marine growth and density etc.
- Access and maintenance concept.

16.2.12.2 Environmental data

The environmental data used as basis for the design should be submitted. This should include:

- Wave data;
- Wind speeds;
- Current profile and turbulence;
- Water depths;
- Soil conditions;
- Marine growth, thickness and specific weight;
- Seismic conditions;
- Design temperatures.

16.2.12.3 Structural design

Fixed Structures

Typical documentation to be submitted for verification of the structural design of a fixed structure will be:

- General arrangement plan;

- Description of computer programs used in design;
- Location and orientation;
- Soil data and foundation analysis;
- Description of scour protection system;
- Structural design brief;
- Design load plan, including design accidental loads;
- Design Calculations with the results of the complete load assumptions: extreme and fatigue load tables (see Section 5). Further, an analysis of the maximum rotor speed, the maximum blade deflection and a Campbell diagram shall be submitted
- Structural categorization plan;
- Selection of materials;
- Structural drawings;
- Fabrication specification, including welding procedures
- Design analyses, both global and local design including temporary phases such as transit;
- Standard details;
- Local arrangement plans;
- Corrosion protection;
- Description of access for inspection and maintenance of the system.

Blades

Reference is made to Sections 7 and 9. Typical documentation to be submitted for verification of the blades will be:

- Main drawings of the rotor blade, including structural design and blade connection
- Calculation reports for blade

16.2.12.4 Machinery and marine systems

Machinery and marine systems are covered by reference to DNV-OS-D101 *Marine and Machinery Systems and Equipment*. Typical systems include ballast system, bilge system, HVAC system. Documentation for such systems should include:

- Functional descriptions;
- Piping (or ducting) and instrumentation diagrams;
- Piping specifications;
- Control system;
- Reliability studies for critical systems;
- Description of the condition monitoring system
- Description, drawings and calculations of Power Take-Off system and components

16.2.12.5 Hydraulic systems

Hydraulic systems are generally covered by reference to DNV-OS-D101 *Marine Machinery Systems and Equipment* for mechanical parts, and by ASME B31.3 for pressure vessel components. Hydraulic systems may be used for a variety of functions, including control systems, braking systems and power take-off systems. Documentation required for verification of such systems will include:

- Hydraulic diagram;
- Functional specification;
- Functional description, including references to valve positions for different operational states;
- Pressure vessel design calculations;
- Piping specifications;
- Control system and instrumentation specifications;
- Reliability studies of critical components.

16.2.12.6 Electrical systems

Electrical systems are normally covered by reference to DNV-OS-D201 *Electrical Installations*. The verification of the electrical system will be based on the following typical documentation:

- System description;
- Line diagram;
- Generator and main electric components specification and data sheet;
- Converter specification;
- Overall single line diagram for emergency power;
- Principal cable routing sketch;
- Cable selection philosophy;
- Load balance;
- Discrimination analysis;
- Electrical system calculations;
- Battery systems;
- Reliability studies for critical systems.

16.2.12.7 Instrumentation and control systems

Typical documentation for the instrumentation and control systems is:

- Functional description of control and safety system;
- System block diagrams;
- Power supply arrangements;
- User interfaces;
- Instrumentation and equipment lists;

- Arrangement and layouts;
- Description of functions covered by software;
- Black start arrangements;
- Emergency shutdown system;
- Reliability studies for critical systems.

16.3 Certification deliverables

The deliverables indicate the incremental nature of the certification process with each stage contributing to the next step. The deliverables provide for the gradual increase in detail and scope from the concept stage through to certification of a fully developed product. Typically these deliverables will be termed as follows:

Statement of Compliances:

- Statement of Feasibility
- Design Assessment
- Verification by prototype testing and measurements
- Manufacturing Assessment
- Product Certificates for Components and Assemblies
- Survey Reports

Certificates:

In order to account for the different stages in the development of the energy converter, DNV GL may issue the following certificates:

- Prototype Certificate
- Conditioned Type Certificate
- Type Certificate
- Project Certificate.

The Statement of Compliance is only issued if there are no outstanding items. Where non safety-relevant items remain outstanding, a Conditioned Statement of Compliance can be issued, with a validity period of one year from issue. Statements of Compliance may be invalidated if modifications in design or manufacturing of the components subject to the Design and Manufacturing Assessment are made without review / consent of the DNV GL.

Final Assessment is carried out prior to the issuing of the Type Certificate and represents the check of all Statements of Compliance on consistency and completeness. Conditioned Statement(s) of Compliance follow(s) to issuance of Conditioned Type Certificate with a validity period of one year from issue.

16.4 Validity of the certificate

Upon a successful Final Assessment the DNV GL issues a Prototype / Type Certificate. The Certificate is only issued where no outstanding items remain. In cases where there are outstanding aspects a Conditioned Certificate can be issued provided none of the outstanding



issues are safety-relevant. The Conditioned Certificate has a validity period of one year. During this validity period, all installed tidal turbines of this type shall be reported quarterly to the DNV GL.

In addition the following shall be reported annually to the DNV GL:

- a list of all installed tidal turbine of that type (with the submitted information to include a statement of the type with precise designation of the variant, serial number, hub height and location)
- a list of all modifications to the design, manufacturing procedures and storage conditions of components subject to Design Assessment, as well as (if applicable) documents for assessment of the modifications
- a list of all damages to components of the installed tidal turbine forming a part of the Design Assessment.

Certification may be withdrawn before the validity period expires, if any part of the Certificate becomes invalid due to unacceptable changes in design, production procedure or due to regular severe damages within production, erection or operation:

Appropriate actions according to the certified ISO 9001:2000 system (or its principles) with respect to complaints and any deficiencies that affect compliance with the requirements for the Type Certificate shall be in place. Records should be kept of all complaints relating to the compliance for the device with the standards and requirements used for the certification. These records as well as documentation for actions taken shall be available to DNV GL and to the certification body which have certified the ISO 9001:2000 system (if applicable). Reporting of these records as well as minor modifications shall be submitted to DNV.

Any safety related accident/failure of the installed certified devices shall be reported immediately to DNV GL together with proposed corrective actions. Such major accidents/failures may result in request for corrective actions to be taken in order to maintain the Certificate.

If no satisfactory corrective action is taken, the Certificate in question will be withdrawn. Certification documents issued by DNV GL shall upon withdrawal or suspension be returned as requested by DNV GL.

Upon expiry of the validity period, re-certification for the prolongation of the certificate validity will be performed at the request of the manufacturer. Where modifications have been made to tidal turbine, these shall be subject to examination. The re-certification process culminates with the re-issuing of the Certificate with a validity period of five years. For the Re-certification, the following documents shall be submitted for assessment by the DNV GL:

- list of valid drawings and specifications
- list of current manufacturing facilities
- list of all modifications to the design of components forming a part of the Design Assessment and, if applicable, documents for assessment of the modifications
- list of changes in the QM system since the last audit
- list of all installed tidal turbine of the type (with the submitted information to include a statement of the type with precise designation of the variant, serial number, hub height, location)

- list of all damages to the installed tidal turbines on all components included in the Design Assessment.

16.5 Prototype certification

16.5.1 General

Prototype certification is performed to enable testing of prototypes, and is based, in principle, on a preliminary design evaluation. As a rule, power and load measurements shall be performed at the prototype level after which they shall be compared to the calculated values. The location of the device is stated on the certificate and the period of validity is limited in time. The certification scope takes into account the duration of deployment and its final objectives. The limitation is proposed in the following subsections.

The documentation listed in [16.2.12] shall be submitted to DNV GL for assessment. The exact scope is to be agreed upon with DNV GL.

The DNV GL will issue a Prototype Certificate depending on the deployment time and based upon successful assessments as defined in the scope of Prototype Certification.

16.5.2 Scope of prototype certification

Based on the certification plan and the requirements of this standard, DNV GL will issue a Prototype Certificate following successful evaluation of the following:

- Design Basis Assessment
- Load Assessment
- Design Assessment
- Test Plan Evaluation
- Manufacturing Surveillance
- Installation Evaluation
- Final Evaluation / Commissioning Inspection
- Periodical Inspections.

The maintenance of the Prototype Certificate is based on successful evaluation of prototype periodical inspections.

16.5.2.1 Prototype design basis assessment

Reference is made to [16.2.2].

Considering the nature and objective of the prototype some of the information on the design basis may be based on some preliminary targets / data and subject to adjustment after information is obtained from the deployment. It is also possible that some of the targets are adjusted to the prototype stage. In this case, it is important that the case is made that the target for the prototype stage will not impair the required learning and data acquisition to consolidate the development towards the Type Certification stage.

16.5.2.2 Prototype load assessment

Reference is made to [16.2.3].

Depending on the defined design life of the prototype fatigue assessment may be assessed in a simplified approach. See [16.5.3].

16.5.2.3 Prototype design assessment

Reference is made to [16.2.4].

During the prototype design assessment, depending on the design life and objectives of prototype (see [16.5.316.5.3]); any areas having no safety implication within the period of validity may be assessed using simplified methods.

All items with safety implications, all support structures and related load assumptions must be analysed in detail. National or local regulations may also require additional detailed analysis.

The following aspects are to be addressed:

- rotor blades
- machinery components
- electrical installations
- support structure
- foundation.

16.5.2.4 Prototype test plan evaluation

Reference is made to [16.2.4].

A test plan for the prototype shall be submitted for evaluation. The Test Plan shall specify main components to be tested during the test period and loads to be documented during the tests.

- safety and function tests
- power performance measurements
- load measurements
- blade tests
- other tests.

16.5.2.5 Prototype manufacturing surveillance

Reference is made to [16.2.4].

The prototype manufacturing surveillance will be carried out by DNV GL. The extent of the surveillance and the amount of samples to be surveyed depends on the standard of the quality management measures, the requirements of this standard and the actions in the certification plan and shall be agreed with DNV GL.

16.5.2.6 Prototype installation evaluation

Reference is made to [16.2.8].

16.5.2.7 Prototype final evaluation / commissioning inspection

Reference is made to [16.2.416.2.9].

16.5.2.8 Prototype periodical inspections

Reference is made to [16.2.11].

The prototype periodical inspections are required for the maintenance of prototype certificate and any long-term extension validity. Details on the prototype periodical inspections are given in Section 15.

16.5.3 Validity of the prototype certificate

The prototype certificate is valid for a specific location and limited to two years starting from the date of deployment. The certification activities at this stage include the following:

- As a rule, power and load measurements shall be performed at the prototype, after which they shall be compared to the calculated values. A measurement plan shall be provided and agreed upon with DNV GL on a case-by-case basis. The measurement plan shall consider requirements about the test site, definition of the measurement load cases and the amount of data required for each, the quantities to be measured and changes in the HATT configuration.
- The Design Assessment is defined in [16.5.2.3] with the focus on extreme loads.
- Modifications, e.g. to the control system are permissible, provided that the safety of the device is not adversely influenced.
- The safety system shall be assessed in detail.
- The ULS of the support structure and the related load assumptions shall be assessed in detail.

Conditions for the extension of the validity of the prototype certificate for up to five years, starting from deployment date, shall be agreed with the DNV GL. In general the following shall be considered:

- After two years the measured power curve and loads are to be compared against assumptions made during the design phase;
- Further operation of the prototype is permissible if original assumptions are verified by measurements (see [16.5.2.4] and [16.5.2.8]) and/or if corrective measures are taken in case of safety relevant deviations;
- Fatigue limit state of the rotor, the nacelle load carrying frame, the support structure and the related load assumptions shall be assessed in detail;
- Modifications, e.g. to the control system are permissible, provided that the safety of the device is not adversely influenced.

For long-term extension of the prototype certificate beyond five years from deployment the following conditions shall be considered:

- The number of prototype certificates is limited to 12 turbines for the type in question and its variants.
- In addition to the requirements for the extended prototype certificate an inspection of the turbine shall be performed by the DNV GL surveyor every 5 years. The inspection includes the detachable parts of the turbine (inspection at the berth) as well as the submerged structure.
- Maintenance and Condition Monitoring System (CMS) protocols to be assessed.
- A full evaluation of the modifications made to date in the control and safety systems due to malfunctions. The modifications would include the impact on:
 - loads assumptions and load cases definition
 - design of the rotor blades

- main structural and electrical components
- personnel safety issues.
- Full load evaluation for the carrying structure including foundation to be carried out.
- Evaluation of the electrical components includes all main components up to grid connection point (the extent of evaluation related to the prototype certification will be dependent on what is included under OEM responsibility).
- Further modifications, e.g. to the control and safety systems are not permissible.

16.5.4 Documentation for the prototype certification

Reference is made to [16.2.416.2.12].

16.6 Type certification

16.6.1 General

The Type Certificate is issued for production model with no outstanding issues (validity of 5 years subject to annual endorsement).

Under Type Certification, the overall design is assessed. The certification covers all components and elements of the HATT built in series over a number of units. Areas for checking, assessment and certification include (but are not limited to) safety, design, construction, manufacturing and overall quality.

Type Certification consists of a review of the Design Basis and Design Assessment, together with an assessment of the quality system, Implementation of the design-related requirements in Production and Erection (IPE), manufacturing evaluation, and witnessing of the test operation of a prototype. Prototype test results regarding power measurement, load measurements and converter behaviour are an integral part of the Type Certification.

Evaluation of the developer's / manufacturer's quality management encompasses all activities necessary to confirm the quality of the product. The certification of the manufacturer's QM system according to ISO 9001 (including design) covers a large portion of these requirements, however the link between quality management and product quality also needs to be specifically addressed. It shall be ensured that the requirements stipulated in the technical documentation with respect to the components are observed and implemented in IPE. The respective IPE assessment requires an inspection in which it shall be demonstrated on at least one specimen that manufacturing has followed the design requirements under certification.

The Conditioned Type Certificate is a specific Type Certificate issued to allow for 0-series production, as well as to allow for outstanding matters with no safety implication. The Conditioned Type Certificate is based on the full certification scope with the exception that outstanding issues are permitted. These outstanding issues (all of which must be addressed within a maximum of 1 year) are limited to:

- areas with no safety implication
- areas related to the finalization of manuals and quality control procedures
- areas related to the finalization of inspections regarding the implementation of the design-related requirements in production and installation

16.6.2 Scope of the type certification

Type Certification shall confirm that tidal turbine-type is designed according to a tidal turbine-class in conformity with the design assumptions based on this standard. It shall also confirm that the manufacturing process, component specifications, monitoring, inspection, test procedures, and the corresponding documentation of the components are in conformity with this standard. The type certificate applies only for a type of tidal turbine, not for actual installations or projects.

To obtain Type Certificate the following certification procedures are to be carried out by the DNV GL as defined below and in Figure 16-1:

- Design Basis evaluation
- design evaluation
- type testing
- manufacturing evaluation
- final evaluation
- foundation design evaluation
- foundation manufacturing evaluation
- type characteristic measurements

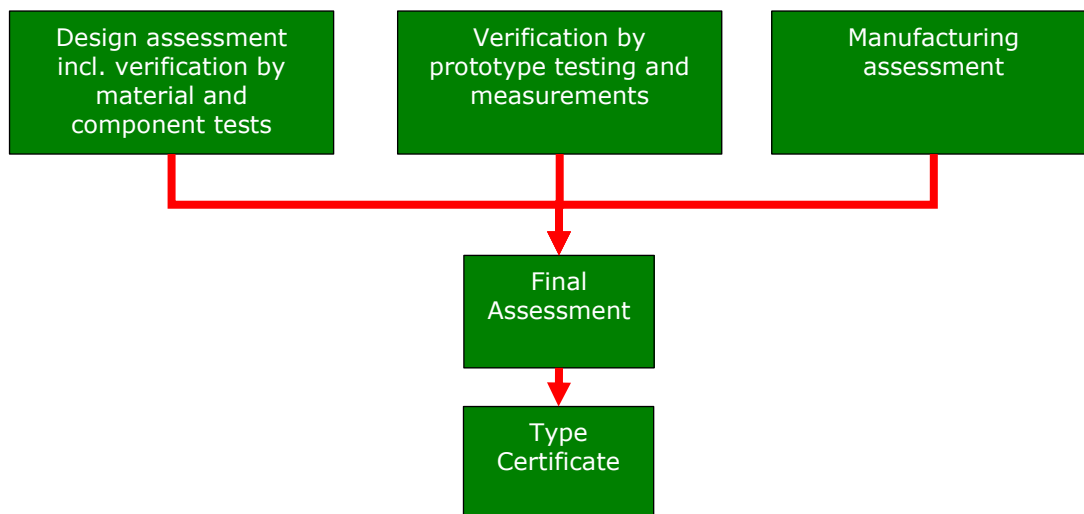



Figure 16-1 Certification modules of the Type Certification

Final Assessment is carried out prior to the issuing of the Type Certificate and represents the check of all Statements of Compliance on consistency and completeness. Conditioned Statement(s) of Compliance follow(s) to issuance of Conditioned Type Certificate with a validity period of one year from issue.

16.6.3 Validity of the type certificate

Reference is made to [16.4].

Upon a successful Final Assessment the DNV GL issues a Type Certificate. The Type Certificate has a validity period of 5 years and is only issued where no outstanding items remain. In cases where a Statement of Compliance contains an outstanding item the Conditioned Type Certificate



can be issued provided none of the outstanding issues are safety-relevant. The Conditioned Type Certificate has a validity period of one year. During this validity period, all installed tidal turbines of this type shall be reported to the DNV GL.

Certification may be withdrawn before the validity period expires, if any part of the Certificate becomes invalid due to unacceptable changes in design, production procedure or due to regular severe damages within production, erection or operation:

Major modifications to the design, procedures, specifications etc. must be reported without delay together with all documentation affected by the modification for the Type Certificate to be maintained/ extended.

Modifications to a device for which a Type Certificate has been issued are permitted only if they do not change or affect the principle characteristics at all. As an example, modifications to the principle characteristics of Type Certificates are defined as follows:

- a change in size or any other modification resulting in loading response increase by more than 2% above the uncertainty calculated/measured and included in the Type Certificate
- a different design of safety/control system
- a different way of limiting the power
- change of main components for other not equivalent as per the qualification process
- increase of the power output by more than 5% above the uncertainty calculated/measured and included in the Type Certificate.

If modifications outside the limitations have been carried out this means that a different type of device has been produced, and a separate Type Certificate for this type should be applied for.

Upon failure to conform to the conditions of the Type Certificate, the Certificate Holder is requested to correct the non-conforming situation within a specified time frame.

If no satisfactory corrective action is taken, the Certificate in question will be withdrawn and the accreditation authority, under whose authority the Type Certificate was issued, will be informed accordingly.

Certification documents issued by DNV GL shall upon withdrawal or suspension be returned as requested by DNV GL.

16.7 Component certification

16.7.1 General

The objective of the component certification is to ensure conformity in respect of a component of a specific type to design assumptions and specific design and fabrication requirements stated in this standard and additional aspects in the Certification Plan.

Certification of Materials and Components (CMC) may be performed analogously by application of the elements and modules as listed in [16.6].

Limitations of application (specification) shall be stated, among others:

- specification of the interface between components and the rest of the tidal turbine
- specification of critical conditions (e.g. operating conditions, loads, dynamic properties).



This standard defines the extent of certification of the procured items that is needed for certification of the energy converter device based on the results of the initial stages of certification (technology assessment, failure mode identification and risk ranking) that are consolidated in the Certification Plan.

The aspects discussed here are based on Technology Class 1 or, in some cases, Technology Class 2.

CMC is a conformity assessment normally including both design and production assessment. The production assessment includes inspection and testing during production and/or of the final product. The design of the materials, components and systems shall either be on a case-by-case basis or follow the procedure for the approval.

16.7.2 Case-by-case approval

When the case-by-case procedure is used, documentation of the design shall be submitted for assessment for every application as required. A design assessment letter or design verification report shall be issued by DNV GL when compliance with the requirements for the design of the actual application is confirmed. The designer must ensure that their design accounts for all relevant design loads, including accidental loads derived from any risk assessment carried out by the project.

The production assessment shall either be on a case-by-case basis or on the basis of an agreed Manufacturing Survey Arrangement (MSA).

When the case-by-case procedure is used, the survey and testing shall be performed on the basis of approved design documentation for the actual application and as required in the standards. Compliance with the approved design documentation and the requirements shall be documented through certificates as required in the standards.

When the production assessment is based on an MSA, the survey and testing shall be performed on the basis of approved design documentation and in accordance with requirements and procedures laid down in the MSA. Compliance with the approved design documentation and the requirements shall be documented through certificates as specified in the MSA or as required in the standards.

16.7.3 Type approval

Type approval is a procedure for design assessment. Type approval can be applied to a:

- Product;
- Group of products;
- System.

This procedure should normally be used for design assessment of standard designs or designs for series-produced products.

When the type approval procedure is used, documentation of the design and the results of type testing as required in type approval programs and the standards shall be submitted for assessment. A type approval certificate shall be issued by DNV GL when compliance with the requirements for the design is confirmed. The validity of type approval certificate should be checked against the maintenance and inspection regime as normally the validity period is variable depending on the type of material, component or system.

The type approval procedure will normally consist of the following elements:

- Design approval;
- Type testing;
- Issuance of type approval certificate.

The type approval procedure used by DNV GL is described in DNV Standard for Certification 1.2.

For certain products, equipment and systems as defined in the standards, type approval is sufficient as the assessment needed for conforming product quality, i.e. production assessment is not required.

For certain products, equipment and systems as defined in the standards; type approval is a mandatory procedure for assessment of design.

For products, equipment and systems manufactured for stock, type approval shall be the normal procedure for assessment of design.

For type approved products, where the basis for the approval is the standards, documentation of the product need not be submitted for approval of each device unless otherwise stated as a condition on the type approval certificate. In such cases only the arrangement or system plans, interface plans and those plans mentioned on the type approval certificate shall be submitted for approval.

16.7.4 Documentation for the certification

Certification of materials, components and systems shall be documented by the following types of documents:

1. DNV GL Product Certificate (NV):

A document signed by a DNV GL surveyor stating:

- Conformity with standard requirements;
- Tests are carried out on the certified product itself;
- Tests are made on samples taken from the certified product itself;
- Tests are performed in the presence of the surveyor or in accordance with special agreements.

2. Works Certificate (W):

A document signed by the manufacturer stating:

- Conformity with standard requirements;
- Tests are carried out on the certified product itself;
- Tests are made on samples taken from the certified product itself;
- Tests are witnessed and signed by a qualified department of the manufacturers.

3. Test Report (TR):

A document signed by the manufacturer stating:

- Conformity with standard requirements;
- Tests are carried out on samples from the current production.



The applicable standards will specify which of the above mentioned documentation will be required.

Where the standards require Works Certificate (W) or Test Report (TR), the surveyor may at any time require tests to be carried out in their presence and/or check elements of the quality control in operation.

For identification and traceability, certified products shall be stamped in accordance with the marking given in the product certificate and as specified by the applicable standards.

For certain components and systems as defined in the standards; the certification may be based on defined internationally recognized standards and certification schemes that cover the overall quality, safety and environmental standard of the rules. Compliance with the requirements of the standard shall be documented as required by the standard.

16.7.5 Manufacturing survey arrangement

When the procedures and processes of a building yard's or a manufacturer's quality system meet the quality, safety and environmental standard of the standards, a MSA may be established with the yard or manufacturer as an alternative to the verification and production assessment described in the applicable standards.

The agreed MSA shall be described in a document stating the requirements, scope, acceptance criteria, documentation and the roles of DNV and the yard or the manufacturer in connection with the production assessment.

When it is agreed through an MSA that the majority of the required surveys and tests are being completed without the presence of a surveyor, it is conditional upon the manufacturer having in operation a quality system certified by an accredited certification body to ISO 9002, or equivalent.

When establishing an MSA, an initial assessment of the manufacturer's ability to control product quality and to comply with the scope, requirements and criteria laid down in the MSA shall be performed. The extent and frequency of periodical assessments of the manufacturer shall be included in the MSA.

An MSA is normally given a validity of 4 years. When the MSA is based on a certified quality system, the MSA automatically becomes invalid if the quality system certification is no longer valid.

16.8 Project certification

16.8.1 Scope of the Project Certification

Project certification shall confirm for a specific site that type-certified tidal turbines and particular support structure designs meet requirements governed by site-specific external conditions and are in conformity with this standard, applicable local codes and other requirements relevant to the site. Within the Project Certification it will be assessed whether the meteorological, oceanographic, bathymetric, soil and other external environmental as well as electrical network conditions at the site conform to those defined in the design documentation for the tidal turbine-type and support structure(s).

Project Certification shall also confirm that manufacture, transport, installation and commissioning processes are in conformity with this standard, and that tidal turbines are operated and maintained in conformity with the relevant manuals.

To obtain a Project Certificate for a single tidal turbine or an array of tidal turbines the certification works detailed in Figure 16-2 are to be carried out:

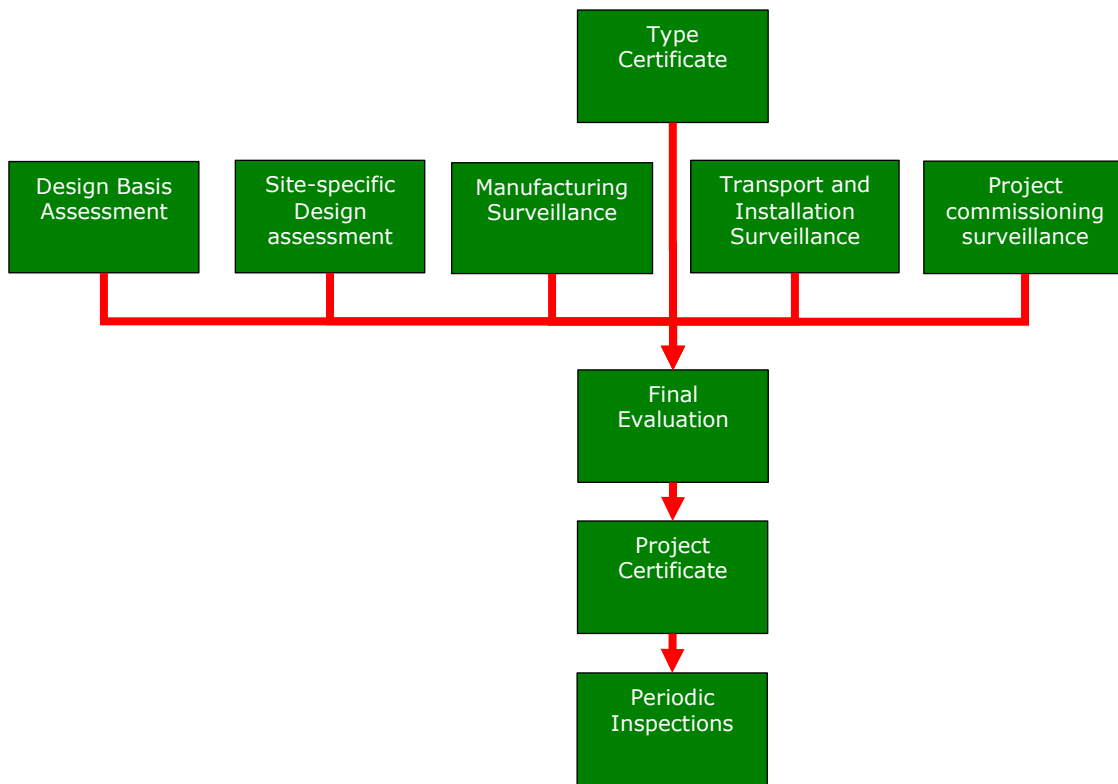

Figure 16-2 Certification modules of the Project Certification

16.8.1.1 Site-specific design basis assessment

Assessment of site Design Basis includes the examination of environment-related influences (design conditions) on the tidal turbine and auxiliary structures of the turbine, and the mutual influence of the tidal turbine configuration.

The following site design conditions have to be documented:

- marine conditions (bathymetry, waves, tides, correlation of wind and waves, sea-ice, scour, marine growth etc.)
- soil conditions
- site and tidal turbine configuration
- other environmental conditions, such as: salt content of the air, temperature, ice and snow, humidity, etc.
- electrical network conditions
- influence of nearby turbine arrays

These site design conditions including reports on measurement results and further analyses will be assessed for plausibility, quality and completeness. The reports shall be provided by accredited measurement institutes.



The site design conditions shall be summarized in the Design Basis, see [1.10.3.1]. Furthermore, the Design Basis shall include all parameters relevant for the tidal turbine array design, stating the methods to be used. If values are taken from background documents, those shall be referenced. All background documentation shall be handed in. The Design Basis will be assessed for plausibility, quality and completeness.

16.8.1.2 Site-specific design assessment

Site-specific Design Assessment is based on the external conditions at the site and takes place with subdivision into the following assessment steps:

- site-specific load assumptions (Section 4 and 5), including requirements for the electrical power network conditions
- comparison of site-specific loads with those from the design assessment of the type of tidal turbine
- site-specific support structure and foundation (Section 8)
- modifications to the machinery components and blades in relation to design assessment, if applicable (Sections 10 and 9)
- stress reserve calculations for the machinery components and blades, if load comparison indicates higher loads than considered in the Design Assessment of tidal turbine (Sections 7, 10 and 9)
- site-specific electrical installation, cables and connections (Section 12)

During the assessment, it shall be shown that the tidal turbine is suitable for the intended site and that the requirements for the structural integrity of the tidal turbine are met with due consideration for the external conditions. For some locations it may be necessary to consider the influence of the environment on the structural properties.

For the erection of a tidal turbine within an array the influence on the loads shall be determined.

Verification of the structural integrity can be provided through a comparison of the loads calculated for the site with the loads used for the Design Assessment within the type certification. It shall be shown that the loads and deflections occurring at tidal turbine are smaller for all relevant sections than those assumed within the Design Assessment within the type certification. Here the corresponding partial load and material safety factors shall be observed. The scope of the comparison shall be determined in consultation with the DNV GL.

If the loads are higher than assumed during the above mentioned Design Assessment, the verification for certain components can be provided in consultation with the DNV GL in the form of residual safety analyses.

It may become obvious during the Site-specific Design Assessment that, due to increased loads, a component needs to be modified or substituted. In this case, the Design Assessment of this component shall be performed.

Design assessment of auxiliary structures (e.g. transformer platform) shall be performed according to the correspondent regulations DNV-OS-J201 *Offshore substations for wind arrays* and GL Rules *Offshore Substations*.

16.8.1.3 Manufacturing surveillance

The extent and amount of the surveillance during manufacture depends on the standard of the quality management measures, and shall be agreed with the certifying authority. Details on the surveillance during manufacture are given in Section 14.

16.8.1.4 Installation evaluation

Surveillance during transport and installation targets to ensure during transport and installation the structural integrity of the tidal turbines, offshore substation, infield cabling and the certification requirements are met.

Before work begins, transport and installation manuals shall be submitted, which take account of any special circumstances relating to the site, where necessary. Installation methods, reparation methods, precautions, application of protections, limit values (e.g. for bolting connection tightening), timing, shall be checked for compatibility with the assessed design as well.

The extent of the surveillance activities and the amount of samples to be surveyed depends on the quality management measures of the companies involved in transport and installation. Details on the surveillance during transport and installation are given in Section 14.

16.8.1.5 Final Evaluation / Commissioning Inspection

Surveillance during commissioning is to be performed for every tidal turbine of an array and shall culminate in final confirmation that the tidal turbine is ready to operate and that it fulfils all standards and requirements to be applied. The commissioning is to be performed under surveillance by the DNV GL.

This surveillance covers witnessing of the commissioning for at least 10% of the tidal turbines to be commissioned. The rest shall be inspected after commissioning and the relevant records shall be scrutinized. These inspections shall be carried out within one year from commissioning. Details on the surveillance during commissioning are given in Section 14.

Final assessment is carried out prior to the issue of the Project Certificate. All parts of the certification (Certification Reports and Statements of Compliance, Type Certificate) will be checked for consistency and completeness with regard to the elements and modules described in this standard.

16.8.1.6 Periodical inspections

Periodic inspections of tidal turbine, cables, subsea hubs, etc. shall be carried out to maintain the validity of the certificate. Condition of the tidal turbine, cables, hubs, etc. shall be monitored periodically by the certification authority in accordance with Section 15. Periodic monitoring shall be carried out and documented by authorized persons accepted by the DNV GL. The Periodic Monitoring interval is five years as a rule. This interval may be varied depending on the condition of the tidal turbine and requirements in the Certification Plan.

Any damage or major repairs shall be reported to the DNV GL. To maintain validity of the certificate, any alterations have to be approved by the DNV GL. The extent to which this work is supervised shall be agreed with the DNV GL. The maintenance records will be inspected by the DNV GL. Details on the periodic monitoring is given in Section 15.

16.8.2 Validity of the project certificate

Following successful completion of the modules mentioned in [16.6.1], the DNV GL will issue Statements of compliance as well as the Project certificate. The Statements of compliance and Project certificate are only issued in case of absence of outstanding items. Where non safety-



relevant items remain outstanding, a Conditioned statement of compliance can be issued. One or more Conditional statements of compliance or a Conditional type certificate lead to a Conditional project certificate.

Project certificate is valid until the end of the dedicated lifetime of the tidal turbine array on the basis that

- periodical inspections are carried out to maintain the project certificate,
- maintenance and repairs are carried out according to the maintenance manual,
- major modifications, conversions and repairs are performed with approval of the DNV GL,
- no unexpected malfunctions occur due to inappropriate design or incorrect assumptions regarding the external conditions.

If these conditions are not fulfilled, the DNV GL is entitled to require re-certification or to terminate the Project certificate's validity.

17 CERTIFICATION TESTS AND MEASUREMENTS

17.1 Introduction

Tests and measurements are carried out in different phases of the fabrication, commissioning and in-service life with different objectives. The types of tests are diverse: from destructive tests used to establish the margin to failure of a particular failure mode under investigation to functional or prototype tests to confirm predictions and identify any unexpected behaviour.

Tests and measurements are defined at three different levels:

- component
- system
- full scale.

Tests and measurements are normally carried out to provide evidence that components, systems and entire devices are able to perform within required safety margins. In some cases, tests and measurements are also a way to obtain essential data to confirm design and manufacturing methodologies feeding back into the next development step.

Performance is associated to all required aspects such as execution of all design functions, efficiency, survivability, reliability and availability.

Tests are normally planned and executed in a rational sequence to provide evidence with statistical relevancy (from large number of production tests to few tests on few complete units) with each stage supporting the next set of tests for more complex components, systems or the entire unit.

The target of this section is description of the tests and measurements required within type and component certification process with due consideration of the level of risks for the purpose of

- validation of numerical models
- identification of potential new failure modes and confirmation of behaviour
- confirmation of design results and functional performance of components, systems and the entire unit.

Guidance note

Checks, tests and measurements during Certification Surveillances (see Section 14) and Periodical Inspections (see Section 15) as part of prototype and project certification process, are intended for

- monitoring of the execution of offshore works on the compliance with approved design requirements
- assurance of required quality of manufacturing and installation process
- assurance of degradation mechanisms during the in-service life are within predictable levels.

<i>Certification scheme</i>	<i>Scope of checks, tests and measurements</i>
Prototype certification	Certification Surveillances: Section 15
Type and component certification	Certification tests and measurements: Section 18
Project certification	Certification Surveillances: Section 15 Periodical Inspections: Section 16

---e-n-d---of---G-u-i-d-a-n-c-e---n-o-t-e---

This section addresses the tests specified for the following components:

- Blade testing
- Main gearbox
- Generator
- Transformer
- Converter
- HV switchgear
- Torque limiter
- Brakes
- HPU

At overall unit level (full scale), the following activities are carried out as part of the commissioning, at rig test and / or during sea-trials:

- Load measurements
- Power performance measurements
- Safety and function tests

The measurement points, the planned scope of the measurements, execution of measurements and their assessment shall be coordinated with DNV GL before installation of the measurement equipment commences.

On completion of the certification tests and measurements, the following activities shall be performed:

- evaluation and documentation of the measurements
- plausibility check of the measurement results
- comparison of the measurement results with the assumptions in the design documentation

The measurement report(s) and the verification by the accredited test institute (if applicable) and the comparison with the assumptions shall be submitted to DNV GL for assessment.

New load measurements as well as safety and function tests are necessary when modification of the component essentially affects loads (as a rule in case of new blades design, rotor diameter, new rated rotational speed). The scope of measurements / tests may be reduced in consultation with DNV GL to those measurement parameters which are influenced by the design modifications.

17.2 Blade testing

17.2.1 General

New rotor blade designs shall be subject to full scale testing in order to verify the computational analysis. The testing shall comprise the main structural properties of the blade such as:

- mass and centre of gravity
- stiffness distribution
- natural frequency
- ultimate strength
- fatigue strength.

17.2.2 Selection of test blade and specification of testing

Full scale testing of blades shall be carried out for all new designed blade types, in case of major changes in the design and after substitution of materials (e.g. sandwich core materials) that significantly influence the structural properties of the blade type. Large structural adhesive joints shall as a rule be retested in case the type of adhesive or the method of surface preparation is modified.

The blade to be tested shall be randomly picked from the blades that have already been produced. It may also be the first blade produced.

The blade to be tested shall be in line with the design documentation (drawings and specifications) that were submitted to the certification body for certification. If local reinforcements (e.g. in the area of the load introduction zones) become necessary for being able to carry out the full-scale test, this shall be agreed with the certification body prior to the testing.

As part of the test report, conformance of the test blade with the design documentation shall be stated.

17.2.3 Parts of the blade to be tested

The tested blade shall be subject to the full required test load (S_{Test}) in the area between the blade root and the majority of the blade length (minimum 70%) for each load direction shall be tested. In addition, if there are sections with critically low residual safeties (e.g. for stability failure) outside this area for certain load cases, these shall be tested as well.

It is assumed that close to the zones of load introduction (loading fixtures, clamps), the loading of the blade structure may be disturbed. See IEC 61400-23 Sec. 10.2 for details. It shall be made sure that undisturbed loading in the following possibly critical areas of the blade is realized:

- The part of the rotor blade between the blade root and the profile section from which the cross-sectional properties only change slowly, constantly and continuously.
- The areas of the rotor blade with the smallest calculated residual safeties for stability failure for each tested load case.
- The areas of the rotor blade where local reinforcements or any other special design features are located.

17.2.4 Natural frequencies and damping determination

The following natural frequencies shall be determined in air and in water using the method in [9.2.8]:

- 1st flap-wise
- 1st edgewise

- 1st torsional
- 2nd flap-wise
- 2nd edgewise

The structural damping shall be determined for the following natural frequencies:

- 1st flap-wise
- 1st edgewise

Guidance note

Usually, for underwater applications, effects of hydrodynamic damping will be of a high magnitude compared to aerodynamic damping effects occurring on tidal turbine blades. Thus, for submerged rotor blades, the importance of structural damping effects is considered to be lower than for tidal turbine blades, as damping of vibrations of the blades during operation is caused by the relatively high viscosity of the surrounding fluid to a high extent. For verification of the hydrodynamic damping and added mass it is expected that relevant measurements are carried out during prototype deployment.

As tidal blades are, in general, short and stiff, edgewise precise characteristics may be less critical. Thus, confirmation of characteristics may be disregarded

---e-n-d---of---G-u-i-d-a-n-c-e---n-o-t-e---

Usually, the measurement of the damping will be done in a testing environment where aerodynamic damping contributes to the results of the measurements. Thus the measured result will always be a combination of both aerodynamic and structural damping. It is therefore important to measure the structural damping with very small blade deflections. The maximum acceptable deflection of the blade tip depends on both the natural frequency and velocity of the blade; the blade response over a set period of time is to be evaluated to determine the maximum acceptable blade tip deflection.

The temperature of the blade will influence the natural frequencies and the damping. It is therefore important to know the temperature of the blade when natural frequencies and structural damping are measured.

17.2.5 Static testing

Full scale static testing of each blade design shall be performed considering the extreme load cases in each of the following five directions:

- (positive) flap-wise direction from pressure side to suction side
- (negative) flap-wise direction from suction side to pressure side
- (positive) edgewise direction from trailing edge towards leading edge
- (negative) edgewise direction from leading edge towards trailing edge
- in torsion only the stiffness distribution is determined, full testing of the structure may be omitted if the torsional extreme loads are not considered to be critical for the blade design.

If edgewise extreme loads are not considered to be critical for the blade design this test can be omitted.

The meaning of flap-wise and edgewise with regard to the testing directions is described in the following note:

Guidance note

Blade design load envelopes can be specified in different coordinate systems. Ambiguities occur when these loads are transformed from the “design load coordinate system” into the “test coordinate system”.

The test loads shall be derived from the design loads as follows, provided that the following three pre-requisites are fulfilled.

- The design loads for the rotor blade are either given in the blade axis coordinate system or in the chord coordinate system. The design loads for analyses are established based on the two maximum and two minimum values of the respective main components (i.e. flap-wise and edgewise or M_x and M_y).
- The test loads shall be compared to the design loads under consideration of a suitable transformation of the design loads into the “test load coordinate system”.
- Even though the approach of performing the blade test in the four main directions of the blade generally disregards any secondary load components, it is generally accepted for certification.

---e-n-d---of---G-u-i-d-a-n-c-e---n-o-t-e---

Provided that the three pre-requisites as given in the note in [17.2.4] are fulfilled, the following shall apply for all sections of the blade that require testing according to [17.2.3]:

$$S_{T_{est},CS_{T_{est}}}(z) \geq \frac{S_{d,CS_{Design}}(z)}{\cos(\alpha_{CS}(z))} \cdot \gamma_{1T} \cdot \gamma_{2T}$$

where:

$S_{T_{est},CS_{T_{est}}}(z)$ is the test load at the respective position z of the blade length in the test coordinate system.

$S_{d,CS_{Design}}(z)$ is the main component of the respective load case to be tested (e.g. $M_{flap,max} = 3000\text{kNm}$) at the respective position z of the blade length in the design load coordinate system. This shall be the same design load coordinate system as the one used for establishing the design loads.

$\alpha_{CS}(z)$ is the angle between the design load coordinate system and the test coordinate system.

$\gamma_{1T} = 1.1$ (safety factor for scattering of the rotor blade characteristics in production, so called blade-to-blade variation factor)

$\gamma_{2T} = 1.1$ (safety factor for deviation between the test temperature and the usual underwater-operation temperature as well as for performing the test in air instead of under water. γ_{2T} may be reduced if the testing conditions are reflecting the operational conditions of the blade after consultation with the certification body).

Edgewise and flap-wise bending loads are normally not applied as a combined test load. For some parts of the blade, in particular at the root, extreme flap-wise or edgewise test loads may be increased to compensate for combined edgewise and flap-wise load effects.



Load application usually consists of fitting one or more load clamps to the blade, and then pulling these load clamps in either the vertical or horizontal direction with a tensioning wire. Multiple load application in several positions simultaneously provides a more representative load distribution of both bending and shear. However, multiple load application will contribute to the static stability of the blade which shall be taken into consideration. The widths of the clamps shall be as small as possible taking the surface pressure into account. The load clamps for a tensioning wire shall align with the neutral axis of the blade to avoid unintended loads in the other directions.

The weight of the load clamps and of the blade itself shall be considered when determining the loads to be applied during the test.

Due to the deflection of the blade the moment arm of the load application point will vary during the test. In order to avoid gross testing errors, this change in moment arm distance shall be considered when calculating the applied bending moment.

Guidance note

As blades for submerged operations are generally quite short and stiff, the deflections are usually relatively small. Thus, the change in moment arm distance due to the blade deflection may be negligible.

---e-n-d---of---G-u-i-d-a-n-c-e---n-o-t-e---

Within the scope of the tests, at least the measurements/recordings listed below shall be performed. The results shall be determined for at least four load levels between 40% and 100% of the maximum test loading for each load case tested:

- The applied loads as well as the angle of attack shall be measured at each load introduction point.
- Deflections shall be measured at the tip and at the middle of the blade. The location of anchor points for the deflection measurements shall be described in a way that second order effects can be identified and allowed for. The stiffness and deflection of the test rig and its influence on the test results shall be compensated for.
- The longitudinal and transversal strains on the main load carrying structure (“girder” or “spar cap”) shall at least be measured at four cross-sections distributed over the test area as per [17.2.3].
- The strains of the leading and trailing edge shall at least be measured at the position of the maximum chord length and at half the blade length.
- The shear strains of the webs in the blade root area shall be measured, preferably at the point of greatest loading.
- Strain measurements may become necessary at other critical points, depending on the local design and loading of the blade structure.
- The temperature in the testing environment shall be continuously recorded.
- Descriptive photos of the test set-up shall be taken beforehand and during the tests.
- Test execution shall be video-recorded, preferably using a high-speed camera in order to be able to analyse possible blade failure occurring during testing. The angle of



recording shall be carefully chosen. If applicable, more than one camera shall be used in order to record test execution from different angles at the same time.

After reaching 100% of the test load the load must be maintained for a period of time to allow for load settling (at least 10s).

After testing, the values obtained by the measurements shall be compared to the values predicted based on calculations. The maximum permissible deviations obtained during testing shall be defined in relation to the precision of the calculations and measurements prior to commencing the tests. Deviations of at most $\pm 7\%$ for the bending deflection, $\pm 5\%$ for the natural frequencies and $\pm 10\%$ for the strains are considered to be permissible as a rule.

After testing, a detailed inspection of the blade shall be carried out. All non-reversible changes shall be reported.

The consequences of the non-reversible changes have to be evaluated against the design assumptions. The conclusions of the evaluation and the measured test data provide the basis for acceptance. The following criteria can be used as a guide in the evaluation:

- Non-Critical Items:
 - Noises with unclear cause during the test.
 - Cracks in the gel coat.
 - Cracks in the adhesive not affecting load carrying strength
 - Cracks and damage in the area of the load clamps that are caused by local effects (for example shear stress, and point loads)
- Critical Items:
 - Total failure of the blade.
 - Severe damage of load carrying laminates.
 - Occurrence of non-reversible buckling in the blade structure.

17.2.6 Fatigue testing

The necessity of full scale or component fatigue testing for certification (e.g. Design Evaluation, Type Certification or and Project Certification) shall be agreed between client and certification body in each individual case. The decision on whether fatigue testing is mandatory for certification shall inter alia consider the following aspects:

- Evidence provided by fatigue tests carried at coupons and other assemblies with relevant statistical significance and deemed to provide relevant information for assessment of fatigue damage expectations for the complete blade
- Cost and effort for fatigue testing in relation to the expected significance of the test results
- Track record and possible damages of the blade revealed during operation, e.g. of prototypes
- Exceptional deformation behaviour under operating loads (e.g. significant deformation of cross-section geometry)

- Design features of which are unusual and not considered to be state of the art (e.g. unusual blade root connection solutions, bond lines between pre-fabricated components etc.)

As a rule, fatigue testing is to be carried on a blade that has been subject to static testing as per [17.2.5] in advance.

Fatigue testing can be carried out in different ways, with the most common methods being:

- Excitation of the blade at its natural frequency by means of a rotating unbalanced mass fixed to the blade. Through control of the rotating mass, it is possible to load a major part of the blade to its design load.
- Forced deflection of the blade by means of hydraulic activation or a similar approach. As this method requires large volume hydraulic systems it is difficult to carry out the test at high frequencies. Only part of the blade will be loaded to its design value when applying the load in one position only; however the applied loads are determined more accurately.

In order to apply the correct load distribution during the fatigue test it is often necessary to apply dead weights to the blade. Especially when using natural frequency excitation it is possible to apply a representative load distribution through the application of two or three dead weights. Fatigue tests in the edgewise direction combined with a static load in flap-wise direction can also be made in this way.

The relevant parts of the blade as per [17.2.3] are to be tested to the design load multiplied by a test factor according to IEC 61400-23. The test load shall then be calculated as for all sections of the blade that require testing:

$$S_{Test}(z) \geq S_{equivalent}(z) \cdot \gamma_{nf} \cdot \gamma_{1T} \cdot \gamma_{ef}$$

where:

$S_{Test}(z)$ is the applied fatigue test load at the respective position z of the blade length.

$S_{equivalent}(z)$ is an equivalent load whose associated fatigue damage is equal to the fatigue damage calculated from the design load spectrum. The equivalent load is dependent on the number of test load cycles.

$\gamma_{nf} = 1.15$ (safety factor for consequences of failure)

$\gamma_{1T} = 1.1$ (safety factor for scattering of the rotor blade characteristics in production)

$\gamma_{ef} = 1.05$ (safety factor compensating for possible errors in the fatigue formulation).

The fatigue test loads shall be developed from the design spectrum.

Guidance note

The procedure for the calculation of equivalent loads shall be based on a numerical model for fatigue damage calculation in the blade material for the main load carrying structure. One recognized procedure is the use of rain-flow counting in conjunction with damage accumulation according to Palmgren-Miner's rule. The model shall consider the effect of mean stress on the fatigue life (e.g. by using the Goodman diagram). Due to anisotropic material behaviour and the very high number of load cycles in combination with climatic effects, the calculated damage value can only be an approximation but it is state of the art. The procedure typically results in a discrete number of constant amplitude test cycles.

---e-n-d---of---G-u-i-d-a-n-c-e---n-o-t-e---

The following issues shall be considered when developing the test plan:

- The increase in load which is required to accelerate the test depends on the slope of the S-N diagram for the details tested. The slope of the S-N diagram (m) may vary significantly for different materials, load directions, and mean stresses. Due to these variations, some areas of the blade may not be tested sufficiently. This may require that those parts of the blade need to be tested separately.
- To provide a comprehensive blade fatigue test, a test series involving more than one applied fatigue test load (load spectrum) should be applied
- The fatigue damage model used for the calculation of equivalent loads shall be verified with a sufficient number of tests approved by the certification body. These tests shall be conducted on representative specimens within the range of mean strains and strain ranges considered for the blade in the transformation from the design load spectrum to equivalent load (see also [7.7.2.3]).
- The tip of the blade may be removed in order to increase the natural frequency – reducing the time required for the test. The tip shall only be removed after initial static testing, with the tip being thoroughly inspected (e.g. by cutting and visual inspection) to detect any manufacturing defects that may have an impact on the fatigue strength. Further criteria for removing the blade tip can be found in IEC 61400-23.

In general the following measurements/recordings shall (continuously) be performed during the entire testing:

- Descriptive photos of the test set-up shall be taken beforehand the tests.
- The temperature in the testing environment shall be continuously recorded.
- Test execution shall be video-recorded, preferably using a high-speed camera in order to be able to analyse possible blade failure occurring during testing. The angle of recording shall be carefully chosen. If applicable, more than one camera shall be used in order to record test execution from different angles at the same time.
- The applied loads shall continuously be recorded.
- The strains in critical areas (e.g. main load carrying structure, leading- and trailing edge, areas of geometry transition, areas of unusual design features etc.) shall continuously be recorded.
- The number of cycles shall be counted.
 - An inspection report of the test blade shall accompany to the test specification in order to keep track of manufacturing defects or repairs, etc.

The fatigue test set-up shall be calibrated at reasonable intervals during the fatigue test. During this calibration the stiffness and strain as function of the bending moment is checked. If no other intervals are specified the following calibration intervals may be used:

- Before commencing the testing.
- At 10^4 load cycles.
- At 10^5 load cycles.

- At $5 \cdot 10^5$ load cycles.
- At each 10^6 load cycles thereafter.
- At test completion

Guidance note

It is recommended that, in agreement with the blade manufacturer, the test laboratory keeps the certification body informed of the results from the fatigue test during the test period.

---e-n-d---of---G-u-i-d-a-n-c-e---n-o-t-e---

Detailed inspections of the blade shall be carried out in regular intervals during as well as after the fatigue testing. All non-reversible changes as well as other abnormalities shall be reported.

The consequences of the non-reversible changes have to be evaluated against the design assumptions. The conclusions of the evaluation and the measured test data provide the basis for acceptance. The criteria as per [17.2.5] can be used as a guide in the evaluation.

17.2.7 Final static testing (residual strength testing)

It is recommended, that after successfully performing the fatigue testing as per [17.2.6], a residual strength test is performed.

The residual strength test shall be carried out with the same requirements as the initial static testing of the blade, mentioned in [17.2.5].

During the (initial) static and fatigue tests some areas of the blade may experience overloading and damage that result in further damage during residual strength testing. In this case, the certification body shall assess the acceptability of these damages.

Guidance note

To facilitate examination of the blade after the residual strength tests, it is recommended that the blade is cut into sections in the critical areas.

---e-n-d---of---G-u-i-d-a-n-c-e---n-o-t-e---

17.2.8 Quality management of testing

Tests shall be supervised according to ISO 17025. The test procedures shall inter alia specify:

- Equipment: Traceability of tested specimen as well as measurement and other equipment. Calibration and accuracy of measurement equipment shall be specified.
- Personnel: Qualification and responsibilities of the individuals being responsible for test execution and executing the test.
- Reporting: Accuracy, clarity and unambiguousness of reporting. Measurement uncertainties.

Tests shall generally be carried out by labs accredited according to ISO 17025. Otherwise the tests shall be witnessed by the certification body.

17.2.9 Reporting

Reporting of the tests shall be prepared in accordance with IEC 61400-23 and shall include as a minimum:

- Date and time of the test
- Person responsible for test execution
- Description and main characteristic data of the rotor blade
- Documentation of the production process of the test blade
- Determination of mass, centre of gravity, natural frequencies and damping
- Data from torsional stiffness measurements
- Stiffness of test rig (angular deflection at extreme loads)
- Temperature in the testing environment during the test and if the blade has been exposed to sunlight
- Location of load clamps.
- Description and derivation of the test loads S_{Test} from the design loads
- Description of the test set-up and method of load introduction
- Description of the measuring facilities and predicted precision of the measurements.
- Equipment numbers for all relevant measurement equipment as well as information regarding their calibration.
- All relevant mechanical measurement parameters (forces, deflections, strains etc.)
- Comparison of actual to required value for the test loads S_{Test} .
- Comparison of calculated and measured mechanical parameters such as deflections and strains.
- Noise, cracks, de-lamination, buckling, permanent deflections or other failure and damage observed during testing
- Any deviations from the test plan
- Repairs carried out during the test.

17.3 Main gearbox

17.3.1 General

Gearbox types intended for installation in the drive train of tidal turbines (main gearbox) shall be subjected to a prototype test at a suitable test bench and also to a prototype test at the tidal turbine for which this gearbox was developed. The prototype test at the test bench serves to check the assumptions made in the design of the gearbox and also to obtain important parameters for the execution of series tests during the production of tidal turbine gearboxes. The fundamental suitability of the gearbox for use in the tidal turbine shall be verified through a prototype test at the tidal turbine by measuring the bearing temperatures, sound and/or vibration behaviour and inspecting the gear contact patterns.

17.3.2 Gearbox prototype test at the test bench

The following items at least shall be observed before and during the test of tidal turbine gearboxes at the test bench:

- The gearbox under test and its essential components shall be uniquely identifiable. The relevant quality documents shall be made available by the time of the test.
- The prototype test at the test bench shall also include the function of the cooling system and the lubrication system. A realistic test bench set-up and the simulation of extreme operating conditions shall be provided.
- The purity of the lubricant used shall be ensured and monitored constantly before and during the test at the test bench. The cleanliness limit stated in the specification shall be met.
- The test torque shall be applied in a minimum of 4 steps up to the nominal torque as defined in the gearbox specification.
- The test shall dwell at each torque step until the sump and bearing temperatures are stable with normal cooling.
- After each torque step, the contact pattern shall be documented. For inaccessible meshes, other methods for the validation of the contact pattern shall be applied e.g. tooth root strain gauges. These contact patterns shall be compared with the assumptions made in the design.
- At planetary stages, the dynamic load share (the product of $K_v \times K_v$) at each torque step shall be measured using tooth root strain gauges.
- Measured parameters such as temperatures, pressures and vibration shall be comprehensively logged. The data shall be stored with an unambiguous relationship to each other and, as far as possible, in a format which can be processed electronically.
- On completion of the prototype test at the test bench, the gearbox shall be so disassembled that the condition of all bearings, gears, shafts, connections etc. can be visually inspected and documented.
- If the test results do not meet the criteria listed in the gearbox specification, then recalculations/redesign shall be performed.

17.3.3 Gearbox Robustness test

A test at elevated load levels shall be conducted to assess robustness and identify weak links. The specific test objectives, procedure and acceptance criteria shall be agreed between turbine manufacturer, gearbox manufacturer and bearing manufacturer. After such testing, the gearbox should be completely disassembled and all components inspected for wear or other distress.

17.3.4 Gearbox prototype test at the tidal turbine

The following items at least shall be observed before and during the test of tidal turbine gearboxes at the tidal turbine:

- The duration of the operation at the tidal turbine shall be specified in consultation with DNV GL. The test shall continue at least until the nominal load of the gearbox is reached. If this load cannot be reached, a lower load can be accepted in consultation with DNV GL.
- Relevant operational parameters such as temperatures, pressures and vibration shall be comprehensively logged and evaluated, together with parameters concerning the load on the gearbox. In addition to the torque, these shall include the loads resulting from the integration of the gearbox within the tidal turbine.

- After the test, the gearbox shall be visually inspected, including a check of contact patterns and an oil analysis. If required a disassembly of the gearbox is necessary after the test period.
- If the test results do not meet the criteria listed in the gearbox specification, then a redesign shall be performed.

17.3.5 Documentation of the prototype tests

All phases of the prototype tests shall be comprehensively documented and evaluated, e.g. by means of measurement data files, photographs, oil analyses, and inspection or disassembly reports. As an important part of the evaluation, an appropriate plan shall be defined for the tests of the series gearboxes. The documentation and evaluation shall be submitted, together with the plan for the tests of series gearboxes, to DNV GL for assessment.

17.4 Generator

Generator types for tidal turbines shall be thermal- and performance-tested according to IEC 60034-1:2010. The measurements shall be performed by personnel from a quality department that are independent of the production or design team.

If the machines are operated at frequency converters, the increased warming caused by the additional harmonics shall be taken into account during the type test as follows:

- Worst-case operating conditions for voltage and power factor, as normally defined in the design documentation of the tidal turbine, shall be applied during the test. This refers to the lowest tolerable operating voltage and currents with the maximum capacitive power factor.
- When carrying out the thermal performance test of the machine, the frequency converter that is used in the tidal turbine should be operated at the same time and according to the worst-case operating conditions.
- If a thermal performance test under the above mentioned conditions is not possible for technical reasons, calculations are permissible as an alternative.

Methods and corresponding calculations shall be provided for assessment (e.g. IEC 60034-29).

Guidance note:

Expanded operating ranges for power factor and voltage are often the result of local requirements given in so-called Grid Codes. These requirements have an influence on the tidal turbine design and must therefore be considered at an early design stage.

---e-n-d---o-f---G-u-i-d-a-n-c-e---n-o-t-e---

17.4.1 Overspeed test

The overspeed test according to IEC 60034-1:2010 sub clause 9.7 shall be performed with each generator type used for tidal turbines:

- for 2 minutes
- with the highest speed, see [12.2.2].
- vibration measurements before and after the overspeed test (as per IEC 60034-14)
- As an alternative, the overspeed test can also be performed during balancing (balancing test before and after overspeed run on the balancing machine).

17.4.2 Routine test

Routine tests shall be performed during the production, with the minimum scope as given in IEC 60034-1:2010 sub clause 9.1.

Additionally, an overspeed test of at least every 10th generator should be performed as specified in this section.

17.4.3 Test of direct drive generator

The test requirements stated in [17.4] and [17.4.1] and [17.4.2] above shall be applied for direct drive generators.

If the type test of the complete generator is not possible due to e.g. dimensional problems in the test field, a segment of this generator shall be tested according to the type tests given in IEC 60034-1 and listed above for a first conclusion of the performance of the generator.

After installation in the turbine the performance of the complete generator shall be tested to verify the results of the segment test.

17.5 Transformer

The type test of the transformer shall be performed according to the international standard series IEC 60076. The type test report shall contain at least following tests:

- Temperature-rise test
- Dielectric type tests

Test conditions and results of these tests will be assessed and shall comply with the requirements of IEC 60076.

If the transformer is operated at a frequency converter, the increased warming caused by the additional harmonics shall be taken into account during the temperature-rise test. When carrying out the temperature-rise test of the machine, the frequency converter that is used in the tidal turbine should be operated at the same time and according to the worst-case operating conditions.

17.5.1 Dry-type transformer

In addition to the tests in [17.5] following test shall be performed for dry-type transformer:

- Lightning impulse test
- If the power transformer enclosure is not designed with a protection degree of IP 55 or higher, the transformer should pass the test E3 according to IEC 60076-16 with humidity of above 95% and water conductivity in the range between 3.6S/m to 4S/m.

17.6 Converter

Type testing and Routine testing of the frequency converter shall be performed in order to verify design assumptions for this component. The measurements shall be performed by personnel from a quality department that are independent of the production or design team. The place of testing will be usually the factory of either the frequency converter or the generator. The following test reports shall be submitted for Design Assessment.

17.6.1 Type testing

Type testing should be performed in the following order immediately after each other: first the heat run, then voltage testing, and finally partial discharge testing

For type testing at least following Electrical Tests according to IEC 62477-1 sub clause 5.2.3 shall be performed:

- Impulse voltage test (IEC 62477-1 sub clause 5.2.3.2)
- AC or DC voltage test (IEC 62477-1 sub clause 5.2.3.4)
- Partial discharge test (IEC 62477-1 sub clause 5.2.3.5)
- Touch current measurement test (IEC 62477-1 sub clause 5.2.3.7)
- Temperature rise test (IEC 62477-1 sub clause 5.2.3.10)
- Protective equipotential bonding test (IEC 62477-1 sub clause 5.2.3.11)

The temperature rise test (see also [17.4]) shall be performed together with the generator type under assessment according to IEC 62477-1 sub clause 5.2.3.10 for the operational mode with the highest operating temperature. This operational mode shall be described, giving frequency, voltage and current at a minimum. The test shall be performed together with the generator and all relevant filters. IEC 62477-1 sub clause 4.6.4.1 and Table 14 shall be observed. The corresponding test report shall be submitted for Design Assessment.

The maximum voltage steepness during normal operation shall be measured at the machine-side and grid-side converters of the type, stated in a measurement report and submitted for Design Assessment. The measurement shall be performed together with the filters used. The rating of the filters shall be part of the measurement report.

The following values shall be measured between generator and frequency converter:

- current rms values
- currents of higher frequencies than 50Hz, measured analogously to IEC 61400-21 Edition 2 sub clause 7.4: Current harmonics, interharmonics and higher frequency components (comment: "analogously" because Part 21 is valid for entire offshore wind turbines)
- maximum possible current of the machine-side converter, and
- for reference purposes, the simultaneous voltage on the DC bus

A frequency converter having forced cooling shall be operated at rated load with fan or blower motor or motors made inoperative, singly or in combination from a single fault, by physically preventing their rotation. This shall be done until a reaction of the frequency converter can be seen. The reaction of the frequency converter's cooling system and the resulting temperatures shall be reported.

If coolants other than air are used, the hydrostatic pressure test according to sub clause 5.2.7 and the loss of coolant test according to sub clause 5.2.4.9.4 of IEC 62477-1 shall be passed successfully as a type test and the reports shall be submitted for Design Assessment.

A vibration test according to IEC 62477-1 sub clause 5.2.6.4 with the requirements given in sub clause 4.9 of IEC 62477-1 shall be performed. After the vibration test visual, dimensional and functional tests shall be performed at the tested frequency converter to identify any impact of



the vibrations to the frequency converter. Test reports and test specification shall be submitted for Design Assessment. It is recommended that the control system as well as the auxiliary systems of the frequency converter are operating during the vibration test. Any reactions of these systems to the applied vibrations should be noticed in the test report.

17.6.2 Routine tests

Each frequency converter shall be routine-tested after production. Routine tests in production should contain the following items at a minimum:

- Tightness of cooling system, except for air-cooled frequency converters
- Plausibility checks of voltage waveform and phase angle
- Preloading and discharging of DC capacitors
- Test of grid synchronization
- Protective bonding impedance test according to IEC 62477-1 sub clause 5.2.3.11.4. The test result shall be compliant with the requirements given in IEC 62477-1 sub clause 5.2.3.11.2.2. If the result is not compliant with these requirements, an exception is possible in the following case: The converter is fully assembled in a closed switchboard by the converter manufacturer and the connection to the protective earthing system of the tidal turbine is effected by more than one means (e.g. by two or more protective bonding cables).
- optional: Heating test, showing the proper heating behaviour of the power semiconductors with the cooling system running
- optional: Burn-in test on semiconductor modules at maximum overload current for maximum overload time

17.7 Medium-voltage switchgear

Medium-voltage switchgear shall comply with the international standard series IEC 62271. This shall be verified through type test records containing at least the following tests:

- dielectric tests
- short-time withstand current and peak withstand current tests
- internal fault

The test reports will be assessed with regard to test conditions and the results of these tests will be assessed; these shall comply with the requirements of IEC 62271. In addition, [12.5.2] shall be observed

17.8 Load measurements

17.8.1 Objectives

Load measurements have the following objectives:

- To validate analytical models used for derivation of loads covering ULS and FLS conditions (including parameters such as hydrodynamic damping and added mass of blades).

- To monitor the loading at the structures and power take-off to allow re-assessment of degradation (for example the determination of actual fatigue damage) and to identify modifications on load patterns indicating a possible change in the condition of the structure of power take-off (for example as part of Condition Monitoring System).

17.8.2 Analytical model validation

Load Measurement plan should be submitted for approval considering the following aspects:

- The areas which data should be collected are to be defined during the design assessment phase with preference to areas which will provide a direct relation with the desired loading to be compared. It is expected that areas covering loading on the blade root, rotor moments and support structure bending moments are considered as a minimum.
- Accuracy of sensor and frequency of sampling are to be adequate to cover the effects that it is required to be captured. Fluctuations of loading due to turbulence will require a high frequency of samplings, but it will vary depending on the effect to be captured (global or local effects).
- The bathymetry of the area where the tidal turbine is installed should be surveyed to account for possible interactions of obstacles in the inflow conditions of the turbine.
- The environmental parameters (current speed and direction, shear profile, turbulence intensities, surface elevation, wave spectrum and wave direction) needs to be recorded with the necessary degree of accuracy and synchronised with the resultant strains, accelerations and motions that are measured and recorded to allow comparison with analytical model. Turbine condition and operational parameters should also be recorded.
- It is expected that as a minimum the comparison of the measured and predicted results shows good agreement considering relevant parameters such as maximum values (including extreme values based on statistical distribution of data) and stress range distribution considering rain-flow count.
- The measurements should cover operational (steady-state and transient) as well as survival conditions.
- The load measurement plan should detail the steps to be taken in order to assure accuracy of equipment and the methodology to filter noise in the measurements. Results should include uncertainty estimation.

Reference is also made to IEC TS 61400-13 *Measurement of mechanical loads* with the following main considerations for tidal turbines:

- Load measurement programmes
- Measurement techniques
- Processing of measured data
- Reporting.

17.8.2.1 Load measurement programmes

The Measurement Load Cases (MLC) should be in line with DLC defined in [5.6.3] covering steady-state operation and transient events.



Capture matrix: bin sizes and number of data sets as well as number of 10-min time series should take into account the characterisation of loading under wave conditions (including direction) and the range of current speed.

Quantities to be measured: the following quantities are to be considered for metocean parameters:

- Current speed and direction
- Current shear profile (ebb and flood)
- Misalignment between current direction and turbine (ebb and flood)
- Sea water density
- Wave elevation, length and direction.

17.8.2.2 Measurement techniques

Sensors: due consideration should be given to the environment and external loads that the sensors and their associated cables can be exposed to. It may be the case that sensors are located in the inner surface of the structural elements or within the blades rather than in the outer surface.

Sensors re-calibration: if, during calibration checks, it is identified that re-calibration is required, methods for re-calibration should be discussed in advance taking into account the conditions of access and possibility for application of external load. Redundancy of sensors should also be considered.

Metocean parameters: the level of accuracy of the measurements carried out is to be considered during the selection of location for instrumentation and the instrumentation itself. Reference is made to IEC 62600-100 and IEC 62600-200. Synchronisation between the current readings and sensors in the turbine and structure should also consider the distance between instrumentation and turbine. Consideration should be given to different type of instruments used simultaneously e.g. ADCP and turbine mounted ADV plus wave buoy.

The calculation or measurement of any additional parameters shall be defined and reported in sufficient detail to allow for repeatability.

17.8.2.3 Processing of measured data

Time series and load statistics: Characterisation of inflow (current speed and turbulence intensity levels, wave height and period).

Load spectra: care should be taken with the acceleration and deceleration phases of the current experienced within every tidal cycle. Steep increments/decrements of the current speed within the 10-minute periods are to be expected especially for current speeds between cut-in and rated. High variation of the mean current speed within the 10-minute period may result in non-representative results.

Load spectra: joint distribution of wave height and period should be considered in the lifetime load spectra. The low cycle fatigue due to directionally opposite ebb and flood cycles to be addressed.

17.8.2.4 Reporting

Local topography: to be adapted to local bathymetry and the requirements of IEC 62600-200.

Capture matrix: to be supplemented with wave and water level conditions.



Time histories and load statistics: typical time histories at current speed and wave conditions.

Equivalent loads: equivalent loads versus current speed and wave conditions.

17.9 Power performance measurements

17.9.1 General

The power take-off performance may be carried out by review, auditing and certification of the process used to measure the power take-off and its integrity. The scope will depend on the level of certification of power take-off required (compatible with the stage of development of the technology). This can vary from certification of complete power curves and general model law to confirmation of maximum power generated to specific environmental conditions.

The IEC 62600-200 establish a procedure for power assessment of tidal energy converters. However this Technical Specification considers that the technology is for one specific site and to a given scale. They do not therefore account for deployment of energy converters at early stages, when the amount of data is limited and compliance with all requirements of the Technical Specifications are not possible. In the case of early stage deployment, the approach described in EquiMar Deliverable D4.2 – Data Analysis and Presentation to Quantify Uncertainty is recommended.

The following main principles should be observed regarding power take-off certification:

- Power take-off measurements should be sufficient to allow for calibration of the analytical model in order that this should also be able to predict, within a reasonable level of certainty, the power take-off for different metocean conditions and site characteristics than those investigated.
- The period of time dedicated to evaluation of power take-off should be defined to allow for the relevant metocean conditions to be recorded and provide the necessary statistical data.
- The main parameters investigated for the power take-off measurements are identified and described from the point of view of the device application.
- Extrapolation of results will need to be based on trends manifested during measurements.
- Reference should be made to any limitations on the measurement process, field characteristics, metocean conditions (e.g. sea states, currents) at site and level of uncertainty that may affect the overall power take-off calculations. The level of availability assumed, and quality of output, should also be referred to.

The following aspects should be observed regarding power performance certification:

- The incident resource to the device(s) must be measured at a point un-influenced by the presence and operation of the device(s) themselves;
- The point at which output from the device is measured must be stated, and any relevant assumptions (such as losses to auxiliary systems) should be quantified;
- The power produced and the incident resource must have common time-stamping;
- Due to the un-controllable nature of the resource, sufficient time must be allowed in the measurement period to collect sufficient data to verify the full range of operation of the system;

- The power performance should be reported with the availability of the device when the resource was available. The time when the incident resource was below or above the range of operation should not be included in availability calculations.

Guidance note

For tidal energy devices, the point of measurement of the incident resource such that it is unaffected by the operating device may normally be assumed to be between three and five characteristic lengths (e.g. rotor diameters) upstream of the device. For wave energy devices, the resource measurement will depend on the directionality of the waves at the site.

The power output measurement point may be discussed on a case-by-case basis as there are often ancillary systems in operation on a prototype or demonstrator that would not exist on a commercial machine. In principle, the presented power performance should be at the 'output terminals' of the device. This normally means at the point of connection between the device and the subsea transmission cable, such that all relevant auxiliary losses are taken into account.

The time required for the power performance verification depends largely on the incident resource. For tidal energy systems, one lunar cycle should be sufficient provided that the device is available for the majority of the time. For wave energy devices it is required that a sufficient number of points on the wave matrix are accounted for to allow interpolation or extrapolation for those which are not. This will be agreed on a case-by-case basis depending on the size of the wave data bins.

For additional guidance, reference is made to the EquiMar protocols and deliverables.

---e-n-d---o-f---G-u-i-d-a-n-c-e---n-o-t-e---

17.10 Safety and function tests

The purpose of safety and function tests is to verify that the tidal turbine subject to the type certification shows the behaviour predicted within the design stage.

Before the start of the tests, a test plan shall be submitted to DNV GL for consultation. The test plan shall comprise following tests:

- test of the control system
- test of the safety system

The test plan shall contain at least following information in respect of every test:

- measurement parameters: time, current speed, current direction, nacelle position, rotational speed, electrical power output, torque of the main shaft or driving torque of the rotor, blade root bending moments, hydraulic pressure at the mechanical brakes, position of braking mechanisms (e.g. blade pitch angle for pitch regulated tidal turbines)
- extent of the measurements (among other minimal duration, number of repetitions),
- precise description of the test, stating the resolution of the measurement data, settings
- envisaged evaluations.

17.10.1 Test of the safety system

Target of this testing is to demonstrate functionality of the protection functions and the turbine reaction upon their trigger by the safety system upon

- “overspeed”
- failure to follow controller demand / detection by the control system of the lost control (at least at “failure of one of two mutually independent braking systems”)
- emergency push-button activation.

17.10.2 Test of the control system

Target of this test is check of the turbines reaction and proper functionality of the control system at least within following situations:

- start-up of the turbine including start of the power production
- normal (automatic) operation within power production
- switch-over to the reduced operational mode / de-rated operation (if foreseen)
- gentle shut-down upon trigger of a protection function in scope of control concept (e.g. at “cable twist”).

17.10.2.1 Scope of the test

The testing shall comprise the operation of the load-relevant functions (LVR) over all load-relevant scenarios, as also required for load calculation. The testing shall support the aim of comparable performance of the LRF in load simulation and on the tidal turbine.

An appropriate testing coverage for the software and hardware shall be achieved. For that, the manufacturer shall choose various testing environments, depending on the purpose of the test. The choice of testing environment and test cases may also be influenced by technical constraints of the manufacturer’s development process and the special tidal turbine design. A high coverage of the system by real hardware components instead of emulation shall be striven for.

A test plan shall be submitted to DNV GL and shall be approved prior to commencement of the tests. For critical tests supervision by DNV GL is required. A test report comprising the presentation and analysis of results and conclusions, including a comparison of the results from the testing and from simulations, shall be submitted to DNV GL.

Testing including controller hardware components shall be performed on a prototype tidal turbine and in a hardware-in-the-loop environment e.g. by using:

- complete control system software applied on the PLC in closed loop with a tidal turbine real time simulator
- a test environment applying single machinery components (e.g. actuators, sensors)
- an assembled tidal turbine nacelle on a test stand with emulation of external conditions

An inspection of selected tests shall be performed by DNV GL. The scope shall be agreed with DNV GL and can be performed in the manufacturer’s controller laboratory, on a prototype tidal turbine site, or in parts also at a sub-supplier’s laboratory. This comprises the inspection of the software and hardware and the inspection of operational tests of normal operation and malfunctioning scenarios. It shall be possible on request to retrace steps of development.



In case the required extent of hardware testing cannot be fulfilled completely during the loads assessment because hardware is not available, the loads assessment can be completed without these tests. Then, the outstanding tests will be delayed until the measurement of loads during the prototype testing and controller hardware testing is completed in this context.

Overall the software and hardware tests shall target at addressing the categories of:

- General function
- Delays and dynamics
- System reaction in case of failure
- Noise corruption

17.10.2.2 Controller development process

The manufacturer shall establish quality management procedures for the development process of the controller comprising at least the LRF of the tidal turbine. The manufacturer shall develop and improve the controller according to the process defined. Testing of the controller software and hardware during the development is required. The load assessment at DNV GL may be performed with the same control software as used by the manufacturer.

Software testing during the development shall be performed e.g. by code inspection, walk through, white box, black box, or software-in-the-loop tests, possibly applying the software also used for load simulation. The software testing shall be documented in a reviewable format, a clear reference to the software version, on which the tests have been performed shall be included in this documentation. The documentation shall be provided to DNV GL for review.

A controller development process shall be set up for all relevant parts of the LRF development, clearly describing the concept of verification for single components of the LRF and the complete system. The controller development process description shall require appropriate methods and specifications for testing of the software and hardware including performance requirements for testing results. The development process description shall include test results and their evaluations in a reviewable format for assessment. Modifications to the LRF due to unmet performance requirements shall be documented as well.

For better maintainability, legibility and failure prevention, the software shall be developed according to a software style guide. The software style guide shall be submitted to DNV GL.

The description of the controller development process is complemented by the requirements set out in [17.10.2.4] and [17.10.2.5].

For the purpose of load calculation during the assessment of the loads at DNV GL, control software executing the LRF shall be submitted to be applied together with the load calculation software. This should be a cross-compiled version of the software as an executable file (e.g. DLL, EXE). The executable file shall have an interface to be connected to DNV GL's load calculation software. The executable file shall give DNV GL access to all LRF functions, as also used within the calculation of the load assumptions of the manufacturer. The executable file shall furthermore provide access to all relevant parameters of the controller within an external file. The documentation shall include an operating manual and the description of the functional characteristics.

17.10.2.3 Documentation requirements

In addition to above mentioned documents, the following documentation shall be developed and can be requested for the certification:



Specification:

- list of functionalities of the system
- product specifications including human machine interface (HMI)
- overview descriptions of functions, together with drawings showing the functional relationships, interfaces between systems, and the spatial arrangement of the hardware at the tidal turbine

QM documentation:

- software quality assurance plan
- system version control
- software style guide.

Test plan for software and hardware tests:

- test specification
- test schedule and responsibilities
- description of test environment setup.

If other proofs and tests provided by the manufacturer are of an equivalent nature, they may be recognized.

In case the development process and the documented verification of the safety, functionality, performance and robustness of the control and safety system in general and of the LRF in particular cannot provide sufficient certainty of a fault-free operation, the following shall be submitted for all relevant control circuits and monitoring devices that have an influence on the load response of the tidal turbine (e.g. power, rotational speed):

- A description covering the following aspects by:
 - The behaviour of the control of the tidal turbine shall be described by a block diagram, if applicable with hierarchical subdivisions. For each block, formulae shall be given to describe unambiguously the input / output response and initial state.
 - The block circuit diagram shall include the input and output signals of the controller and the interconnections of the blocks used. Signal paths shall be provided with arrows to indicate their direction of effect. Each signal in the block circuit diagram shall be named unambiguously.
 - The functional relationship between inputs and outputs of the individual blocks of the controller shall be described in the form of discrete-time static or dynamic model equations (for linear blocks, Z-transfer functions are permissible) with statement of the time step, or in another reasonable way.
 - The interface between the control algorithms and the rest of the turbine control system shall be presented, i.e. inputs and outputs need to be qualified and linked explicitly with turbine model signals.
 - The signals and parameters needed for the function of the controller shall be given with their units in summarized form in a table. To ease further



parameterization of the controller, it is suggested that all parameters are summarized within an accessible, external file.

- The source code implementing the LRF in the control and safety system.
- Test signals:
 - The manufacturer shall demonstrate the behaviour of the controller with test cases of time series in closed-loop simulation.
 - Furthermore, test cases with the controller operating in isolation shall be submitted on demand of DNV GL, e.g. controller input signal perturbation tests.

The test cases to be submitted and the format shall be agreed with DNV GL.

17.10.2.4 Transfer of controller from simulation stage to on-site tidal turbine

The development process shall comprise documentation which shows how the LRF, as used within the load calculation, will be transferred to the hardware and its application software at the tidal turbine. The described process shall ensure that the functions and performance are transferred to the target on-site tidal turbine with an appropriate accuracy. If applicable, this includes intermediate stages, e.g. testing within a hardware-in-the-loop environment, manual programming of the routines with subsequent testing or automatic compilation processes.

17.10.2.5 System version control

With respect to the LRF, a quality management process shall be set up to clearly define and document the version numbers of the constituent elements of the control system (e.g. controller software version, parameter definition version, subsystem firmware version).

The documentation to be submitted shall comprise the following:

- A system version control shall be implemented to document subsequent modifications of the system in a retraceable manner. The numbering of the system version control shall differentiate between grades of relevance.
- Modifications of the LRF are subject to re-certification of the respective parts of the whole process and, if relevant, also the load assumptions and component verification. Other load-relevant modifications shall be classified such that they are covered by the certification. The grading of the system version control shall be agreed with DNV GL.
- The system version control shall comprise a configuration management which allocates a permissible configuration of tidal turbine, e.g. tower, rotor blades etc., to the LRF implemented in the application software in the tidal turbine. The user interface at the tidal turbine shall give access to the actual system version installed. This information may be reviewed during commissioning Testing and during Periodic Monitoring of tidal turbines.

APPENDIX A – TECHNOLOGY ASSESSMENT, NOVEL ASPECTS AND FMIRR



TA+NA+FMIRR.xlsx

APPENDIX B – DIAGRAMMATIC PRESENTATION OF TIDAL TURBINES CONTROL AND SAFETY SYSTEMS

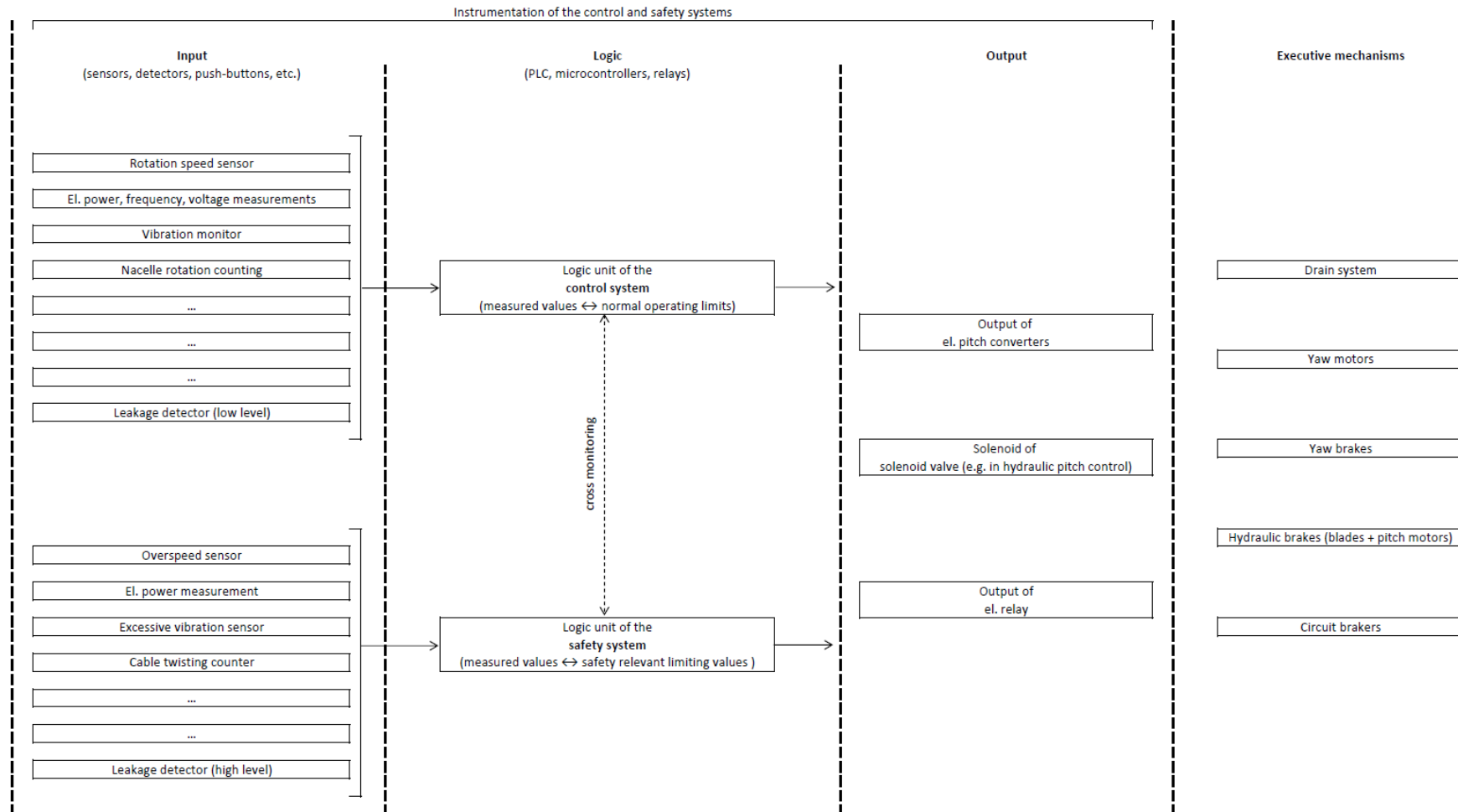

APPENDIX C – SUMMARY ON THE PROTECTION FUNCTIONS DESIGN “TURBINE BEHAVIOUR ON EXCESSIVE CABLE TWIST” (EXAMPLE)

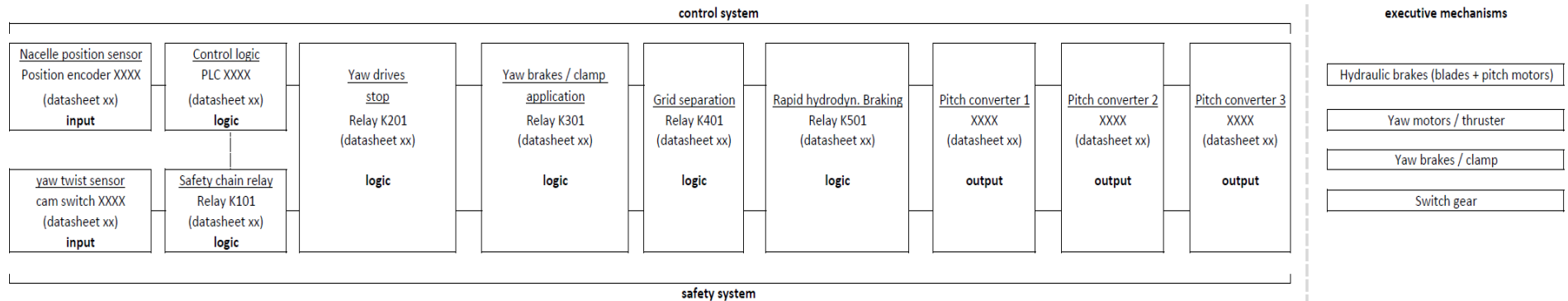
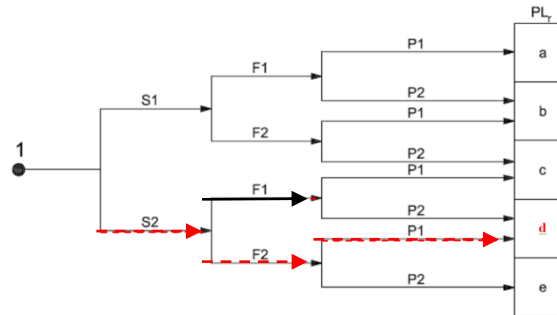

<i>Entire protection function "cable twisting"</i>						<i>Components</i>				
PL_r^*	PL^*	$Category^*$	$MTTF_d^*$	$DC_{(avg)}^*$	CCF^*	<i>Component</i>	PFH^*	$MTTF_d^*$	$DC_{(avg)}^*$	CCF^*
d	d	3				...				
						...				
						Relay K201				
						Relay K301				
						...				
						Pitch converter 3				

* Proves / calculations according to ISO 13849-1.

APPENDIX D – CONTROL AND SAFETY CONCEPT SUMMARY (EXAMPLE)

Measured values	Normal operating limits		Control system behaviour	Safety-relevant limiting values		Safety system behaviour
	Parameter	Value		Parameter	Value	
Rotational speed	Cut-out rotor speed, n_4 , rpm			Activation rotor speed, n_A , rpm		
	Averaging time, s			Averaging time, s		
Electrical power	Over-power, P_T , W			Activation power, P_A , W		
	Averaging time, s			Averaging time, s		
Excessive vibration/shock	Max. acceleration, m/s^2			Max. acceleration, m/s^2		
	Averaging time, s			Averaging time, s		
Leakage detection	Allowable low level, cm			High level limit, cm		
Short circuit	-			Current I_{max} , A		
Cable twisting	Untwisting trigger angle, °			Activation twisting angle, °		
Estop	-			Delay of mech. brake application, s		
Control system hang detection (by watchdog)	-			Watchdog time step, s		
Mechanical brake wear detection (see section 12.5.23)						
Electrical frequency	Allowable frequency fluctuation					
Electrical voltage	Over-voltage, U_T , V					
Grid loss	Frequency Voltage					
Current speed	Cut-out current speed, m/s					

<i>Measured values</i>	<i>Normal operating limits</i>		<i>Control system behaviour</i>	<i>Safety-relevant limiting values</i>		<i>Safety system behaviour</i>
	<i>Parameter</i>	<i>Value</i>		<i>Parameter</i>	<i>Value</i>	
Rotor oblique inflow	Averaging time, s					
	Short-term cut-out current speed, m/s					
	Averaging time, s					
	Max. yaw error for shut down ϕ_A					
Rotor oblique inflow Allowable difference between measured and demanded blade pitch angle	Averaging time, s					
	Cut-out value for difference between measured and demanded blade pitch angle, °					
Blade overrun	Blade overrun pitch angle, °					
Functionality of essential machinery components	Gear oil pressure, Pa					
	Generator winding temperature, °C					
	Bearing temperature, °C					
	Allowable difference of pitch angle measurements (by comparison of measurements of different sensors), °					
Air condition in the nacelle	Start-up of ventilation					
Plausibility of measurements	Allowable difference of rotor speed measurements (by comparison of measurements of different sensors), rpm					
	Allowable difference of current direction measurements (by comparison of measurements of different sensors), °					

<i>Measured values</i>	<i>Normal operating limits</i>		<i>Control system behaviour</i>	<i>Safety-relevant limiting values</i>		<i>Safety system behaviour</i>
	<i>Parameter</i>	<i>Value</i>		<i>Parameter</i>	<i>Value</i>	
		Allowable difference of current speed measurements (by comparison of measurements of different sensors), m/s				
Operativeness of navigation / collision warning equipment						

APPENDIX E – GENERATOR PARAMETERS FOR ELECTRICAL CALCULATIONS AND SIMULATIONS

Generator parameters are required for static and dynamic electrical calculations and simulations. The values shall be applied in accordance with the information supplied by the generator manufacturer. The tables below exemplify the main synchronous and asynchronous generator parameters.

The *synchronous machine parameters* are:

<i>Variable</i>	<i>Description</i>	<i>Unit</i>
S_n	Rated power	kVA
M_n	Rated torque	kN
U_n	Rated voltage	V
P	Number of poles	-
f_n	Nominal frequency	Hz
X_l	Leakage reactance	p.u.
r_a	Armature resistance	p.u.
X_d	d-axis synchronous reactance	p.u.
X_d'	d-axis transient reactance	p.u.
X_d''	d-axis subtransient reactance	p.u.
T_{d0}'	d-axis open circuit transient time constant	s
T_{d0}''	d-axis open circuit subtransient time constant	s
X_q	q-axis synchronous reactance	p.u.
X_q'	q-axis transient reactance	p.u.
X_q''	q-axis subtransient reactance	p.u.
T_{q0}'	q-axis open circuit transient time constant	s
T_{q0}''	q-axis open circuit subtransient time constant	s
$T_a = 2H$	Mechanical starting time (2 x inertia constant)	kWs / kVA
D	Damping coefficient	-
$S(1.0)^*$	1 st saturation factor	-
$S(1.2)^*$	2 nd saturation factor	-

* optional fields

The generator manufacturer shall indicate whether the generator parameters given are of a saturated or non-saturated type.

The asynchronous machine parameters are:

<i>Variable</i>	<i>Description</i>	<i>Unit</i>
S_n	Rated power	kVA
M_n	Rated torque	kNm
M_k	Breakdown torque	kNm
s_k	Breakdown slip	-
U_n	Rated voltage	V
f_n	Rated frequency	Hz
r_s	Stator resistance	p.u.
X_s	Stator reactance	p.u.
r_{r1}	Rotor resistance (single cage)	p.u.
X_{r1}	Rotor reactance (single cage)	p.u.
r_{r2}	Rotor resistance (double cage)	p.u.
X_{r2}	Rotor reactance (double cage)	p.u.
X_m	Magnetization reactance	p.u.
H_m	Inertia constant	kWs/kVA



About DNV GL

Driven by our purpose of safeguarding life, property and the environment, DNV GL enables organizations to advance the safety and sustainability of their business. We provide classification and technical assurance along with software and independent expert advisory services to the maritime, oil and gas, and energy industries. We also provide certification services to customers across a wide range of industries. Operating in more than 100 countries, our 16,000 professionals are dedicated to helping our customers make the world safer, smarter and greener.